

Ambient Light Sensor

The ISL29001 is an integrated ambient light sensor with ADC and I²C interface. With a spectral sensitivity curve matched to that of the human eye, the ISL29001 provides 15-bit effective resolution while rejecting 50Hz and 60Hz flicker caused by artificial light sources.

In normal operation, the ISL29001 consumes less than 300µA of supply current. A software power-down mode controlled via the I²C interface disables all but the I²C interface. A power-down pin is also provided which reduces power consumption to less than 1µA.

The ISL29001 includes an internal oscillator which provides 100ms automatic integration periods, or can be externally timed by I²C commands. Both the internal timing and the illuminance resolution can be adjusted with an external resistor.

Designed to operate on supplies from 2.5V to 3.3V, the ISL29001 is specified for operation over the -40°C to +85°C ambient temperature range. It is packaged in a clear 6-pin ODFN package.

Ordering Information

PART NUMBER	PACKAGE	TAPE & REEL	PKG. DWG. #
ISL29001IROZ (See Note)	6-Pin ODFN (Pb-Free)	-	MDP0052

NOTE: Intersil Pb-free plus anneal products employ special Pb-free material sets; molding compounds/die attach materials and 100% matte tin plate termination finish, which are RoHS compliant and compatible with both SnPb and Pb-free soldering operations. Intersil Pb-free products are MSL classified at Pb-free peak reflow temperatures that meet or exceed the Pb-free requirements of IPC/JEDEC J STD-020.

Pinout

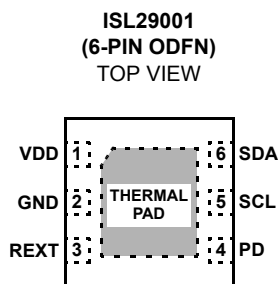

Features

- Human eye response
- Temperature compensated
- 15-bit effective resolution
- Adjustable resolution: 3 to 15 counts per lux
- Simple output code, directly proportional to lux
- 0.3 lux to 10,000 lux range
- IR rejection
- 50Hz/60Hz rejection
- I²C interface
- 2.5V to 3.3V supply
- 6-pin ODFN (2.1mm x 2mm)
- Pb-Free plus anneal available (RoHS compliant)

Applications

- Ambient light sensing
- Ambient backlight control
- Temperature control systems
- Contrast control
- Camera light meters
- Lighting controls
- HVAC

Block Diagram

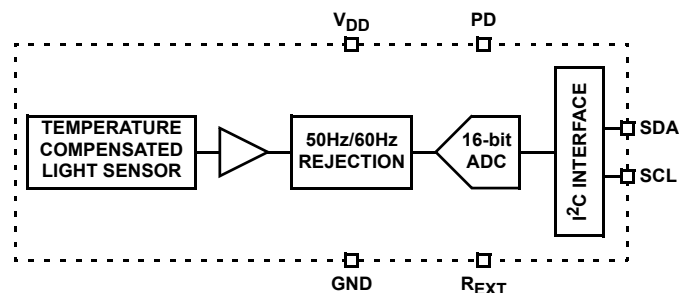

ISL29001

Absolute Maximum Ratings (T_A = 25°C)

Maximum Supply Voltage between V _{DD} and GND	3.6V	Maximum Die Temperature	+125°C
I ² C Bus Pin Voltage (SCL, SDA)	-0.2V to 5.5V	Storage Temperature	-45°C to +100°C
I ² C Bus Pin Current (SCL, SDA)	<10mA	ESD Voltage2kV
R _{ext} Pin Voltage	-0.2V to 3.6V		
Operating Temperature	-45°C to +85°C		

CAUTION: Stresses above those listed in "Absolute Maximum Ratings" may cause permanent damage to the device. This is a stress only rating and operation of the device at these or any other conditions above those indicated in the operational sections of this specification is not implied.

IMPORTANT NOTE: All parameters having Min/Max specifications are guaranteed. Typical values are for information purposes only. Unless otherwise noted, all tests are at the specified temperature and are pulsed tests, therefore: T_J = T_C = T_A

Electrical Specifications V_{DD} = 3V, T_A = 25°C, R_{EXT} = 100kΩ, internally controlled integration timing (Note 1), unless otherwise specified.

PARAMETER	DESCRIPTION	CONDITION	MIN	TYP	MAX	UNIT
V _{DD}	Power Supply Range		2.25		3.63	V
I _{DD}	Supply Current			0.28	0.33	mA
I _{DD1}	Supply Current	Software disabled		0.09	0.10	mA
I _{DD2}	Supply Current	PD = 3V			0.5	μA
FUPD	Internal Update Time	Mode 1 & Mode 2 (Note 2)	85	105	126	ms
Fosc	Internal Oscillator Frequency			312		kHz
F _{I²C}	I ² C Clock Rate		1		400	kHz
DATA0	ADC Code	Ev = 0 lux			1	Counts
DATA1	ADC Code	Full scale ADC count value			32768	Counts
DATA2	ADC Code	Ev = 300 lux, fluorescent light, Mode 1	738	983	1247	Counts
DATA3	ADC Code	Ev = 300 lux, fluorescent light, Mode 2		98		Counts
V _{REF}	Voltage of R _{EXT} Pin		0.487	0.51	0.532	V

NOTES:

1. See Principle of Operation
2. There are three modes of the ADC's operations. In Mode 1, the ADC integrates the current of the photodiode which is sensitive to visible and infrared light. In Mode 2, the ADC integrates the current of the photodiode which is sensitive only to infrared light.

Pin Descriptions

PIN NUMBER	PIN NAME	DESCRIPTION
1	VDD	Positive supply. Connect this pin to a clean 2.5V to 3.3V supply.
2	GND	Ground pin
3	PD	Power-down pin. This pin is active-high. Applying a logic "high" to this pin will put the device into power down mode.
4	REXT	External resistor pin for ADC reference. Connect this pin to ground through a (nominal) 100kΩ resistor.
5	SCL	I ² C serial clock
6	SDA	I ² C serial data

Typical Performance Curves (R_{ext} = 100kΩ)

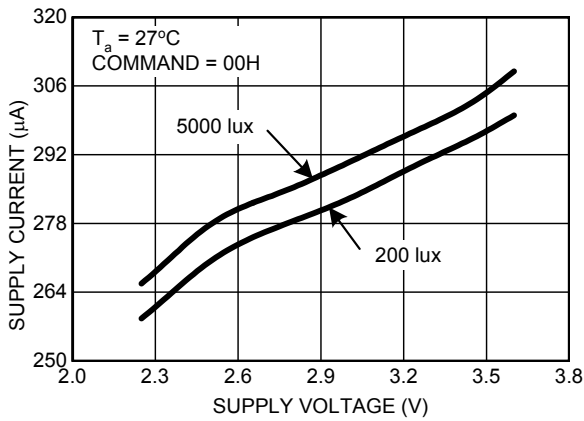

FIGURE 1. SUPPLY CURRENT vs SUPPLY VOLTAGE

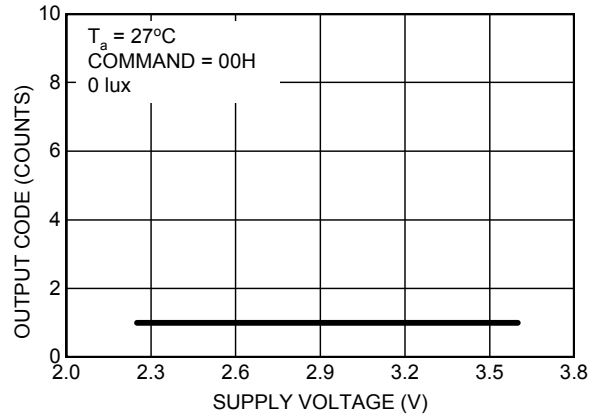

FIGURE 2. OUTPUT CODE FOR 0 LUX vs SUPPLY VOLTAGE

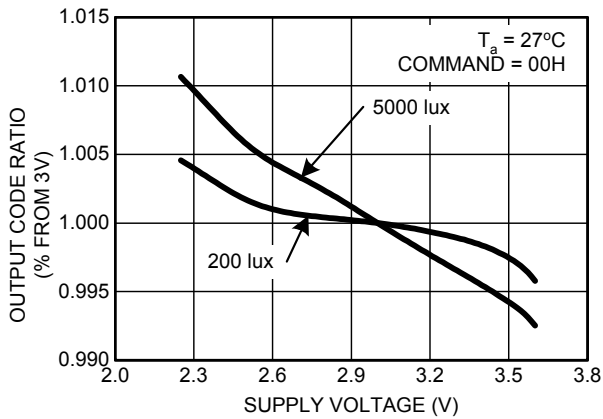

FIGURE 3. OUTPUT CODE vs SUPPLY VOLTAGE

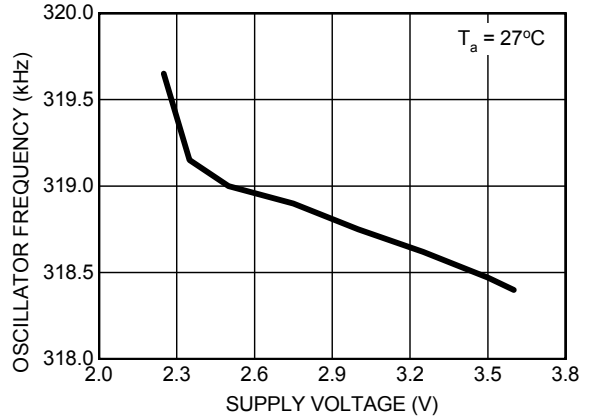

FIGURE 4. OSCILLATOR FREQUENCY vs SUPPLY VOLTAGE

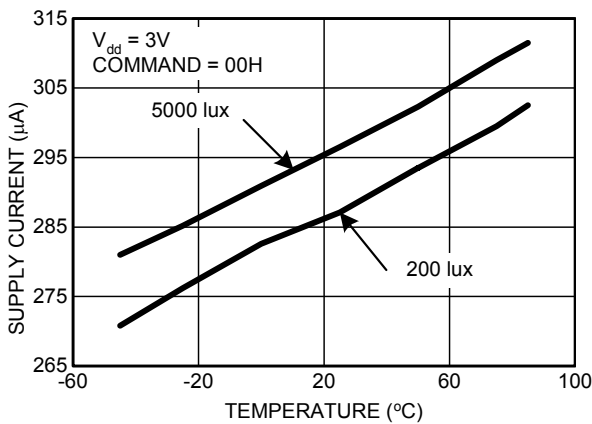

FIGURE 5. SUPPLY CURRENT vs TEMPERATURE

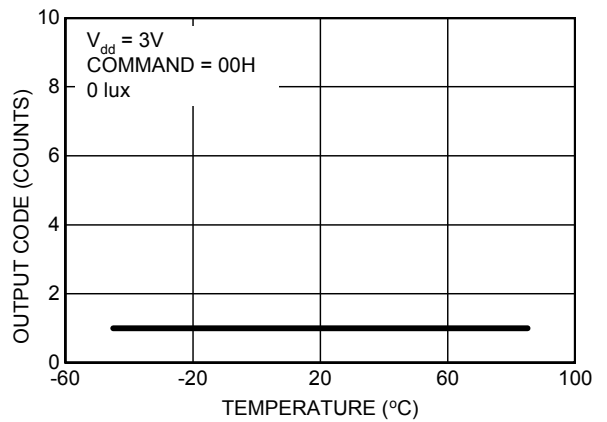

FIGURE 6. OUTPUT CODE FOR 0 LUX vs TEMPERATURE

Typical Performance Curves ($R_{ext} = 100k\Omega$) (Continued)

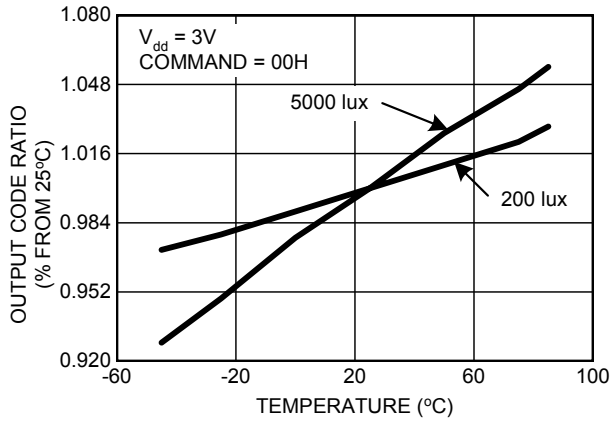

FIGURE 7. OUTPUT CODE vs TEMPERATURE

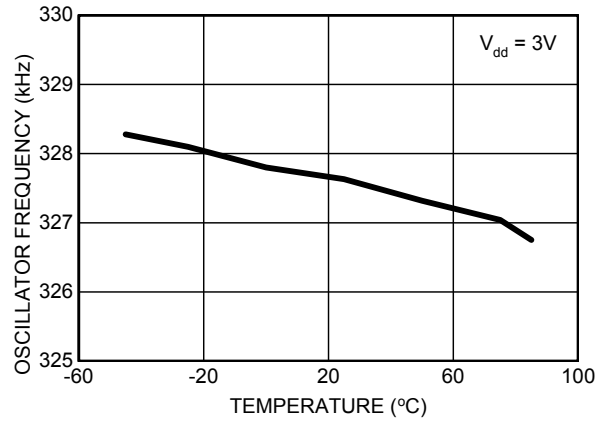

FIGURE 8. OSCILLATOR FREQUENCY vs TEMPERATURE

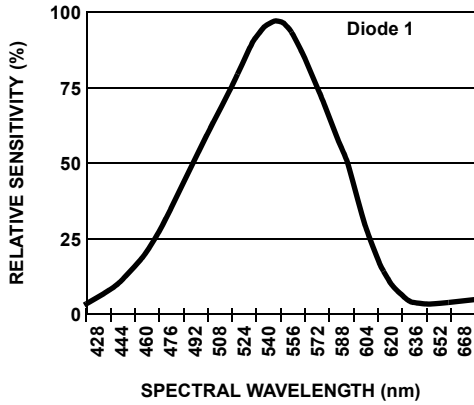

FIGURE 9. RELATIVE SENSITIVITY

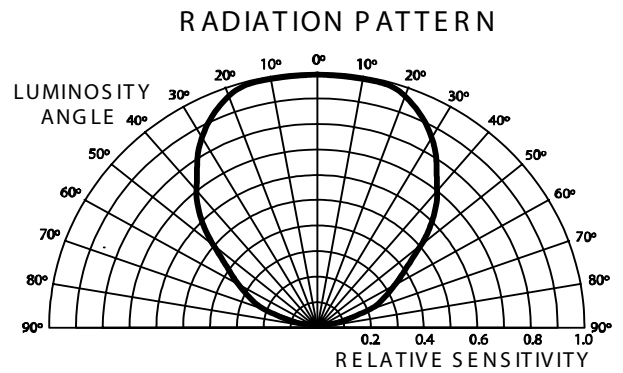

FIGURE 10. RADIATION PATTERN

Principles of Operation

Photodiodes and ADC

The ISL29001 contains two photodiodes. One of the photodiodes is sensitive to visible and infrared light (Diode 1) and the other is sensitive primarily to infrared light (Diode 2). The ISL29001 also contains an on-chip integrating analog-to-digital converter (ADC) to convert photodiode currents into digital data.

The ADC has three operating modes with two timing controls. (Please consult Table 1 for a complete list of modes.) In the first operating mode, the ADC only integrates Diode 1's current, and the digital output format is 16-bit unsigned-magnitude. In second operating mode, the ADC's operation is the same, except Diode 2's current is integrated. In the third operating mode, the ADC integrates Diode 2's current first, then Diode 1's current. The total integration time is doubled, and the digital output is the difference of the two photodiode currents (Diode 1's current - Diode 2's current). In this mode, the digital output format is 16-bit 2's-complement. Any of the three operating modes can be used with either of the two timing controls (either internally or externally controlled integration timing).

The interface to the ADC is implemented using the standard I²C interface.

I²C Interface

The ISL29001 contains a single 8-bit command register that can be written via the I²C interface. The command register defines the operation of the device, which does not change until the command register is overwritten.

The ISL29001 contains four 8-bit data registers that can be read via the I²C interface. The first two data registers contain the ADC's latest digital output, while the second two registers contain the number of clock cycles in the previous integration period.

The ISL29001's I²C address is hardwired internally as 1000100.

Figure 11 shows a sample one-byte read. (A typical application will read two to four bytes, however.) The I²C bus

master always drives the SCL (clock) line, while either the master or the slave can drive the SDA (data) line. Every I²C transaction begins with the master asserting a start condition (SDA falling while SCL remains high). The following byte is driven by the master, and includes the slave address and read/write bit. The receiving device is responsible for pulling SDA low during the acknowledgement period.

Any writes to the ISL29001 overwrite the command register, changing the device's mode. Any reads from the ISL29001 return two or four bytes of sensor data and counter value, depending upon the operating mode. Neither the command register nor the data registers have internal addresses, and none of the registers can be individually addressed.

Every I²C transaction ends with the master asserting a stop condition (SDA rising while SCL remains high).

For more information about the I²C standard, please consult the Philips® I²C specification documents.

Command Register

The command register is used to define the ADC's operations. Table 1 shows the primary commands used to control the ADC.

Note that there are two classes of operating commands: three for internal timing, and three for external (arbitrary) timing.

When using any of the three internal timing commands, the device self-times each conversion, which is nominally 100ms (with R_{EXT} = 100kΩ).

When using any of the three external timing commands, each command received by the device ends one conversion and begins another. The integration time of the device is thus the time between one I²C external timing command and the next. The integration time can be between 1 and 100 milliseconds. The external timing commands can be used to

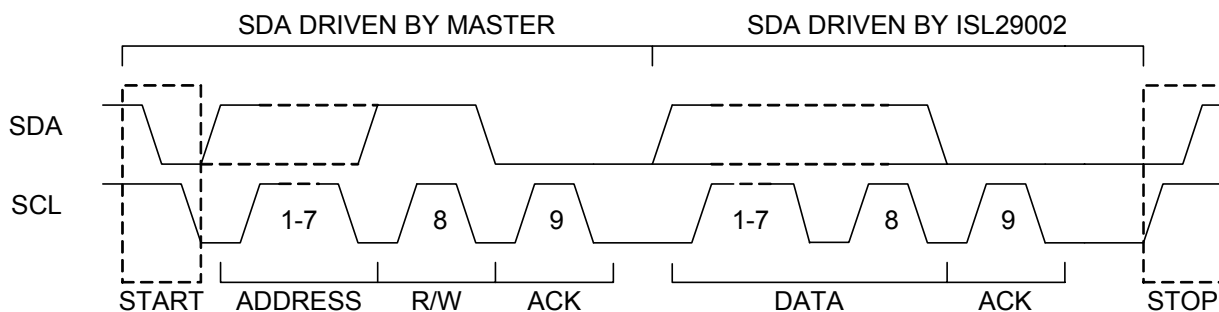

FIGURE 11. I²C TIMING DIAGRAM

synchronize the ADC's integrating time to a PWM dimming frequency in a backlight system in order to eliminate noise.

TABLE 1.

COMMAND	FUNCTION
8cH	ADC is powered-down.
0cH	ADC is reset.
00H	ADC converts Diode 1's current (I_{DIODE1}) into unsigned-magnitude 16-bit data. The integration is internally timed at 100ms per integration.
04H	ADC converts Diode 2's current (I_{DIODE2}) into unsigned-magnitude 16-bit data. The integration is internally timed at 100ms per integration.
08H	ADC converts I_{DIODE1} - I_{DIODE2} into 2's-complement 16-bit data. The total integration is internally timed at 200ms per integration.
30H	ADC converts Diode 1's current (I_{DIODE1}) into unsigned-magnitude 16-bit data. The integration is externally timed; each 30H command sent to the device ends one integration period and begins another.
34H	ADC converts Diode 2's current (I_{DIODE1}) into unsigned-magnitude 16-bit data. The integration is externally timed; each 34H command sent to the device ends one integration period and begins another.
38H	ADC converts I_{DIODE1} - I_{DIODE2} into 2's-complement 16-bit data. The integration is externally timed; each 38H command sent to the device ends one integration period and begins another.
1xxx_xxxxB	I ² C communication test. The value written to the command register can be read back via the I ² C bus.

Data Registers

The ISL29001 contains four 8-bit data registers. These registers cannot be specifically addressed, as is conventional with other I²C peripherals; instead, performing a read operation on the device always returns all available registers in ascending order. See Table 2 for a description of each register.

TABLE 2.

ADDRESS	CONTENTS
00H	Least-significant byte of most recent sensor reading.
01H	Most-significant byte of most recent sensor reading.
02H	Least-significant byte of integration counter value corresponding to most recent sensor reading.
03H	Most-significant byte of integration counter value corresponding to most recent sensor reading.

The first two 8-bit data registers contain the most recent sensor reading. The meaning of the specific value stored in these data registers depends on the command written via the I²C interface; see Table 1 for information on the various commands. The first byte read over the I²C interface is the least-significant byte; the second is the most significant. This byte ordering is often called "little-endian" ordering.

The third and fourth 8-bit data registers contain the integration counter value corresponding to the most recent sensor reading. The ISL29001 includes a free-running oscillator, each cycle of which increments a 16-bit counter. At the end of each integration period, the value of this counter is made available in these two 8-bit registers. Like the sensor reading, the integration counter value is read across the I²C bus in little-endian order.

Note that the integration counter value is only available when using one of the three externally-timed operating modes; when using internally-timed modes, the device will NAK after the two-byte sensor reading has been read.

Internal Timing

When using one of the three internal timing modes, each integration period of the ISL29001 is timed by 32,768 clock cycles of an internal oscillator. The nominal frequency of the internal oscillator is 327.6kHz, which provides 100ms internally-timed integration periods. The oscillator frequency is dependent upon an external resistor, R_{ext} , and can be adjusted by selecting a different resistor value. The resolution and maximum range of the device are also affected by changes in R_{ext} ; see below.

The oscillator frequency can be calculated with the following equation:

$$f_{osc} = 327.6\text{kHz} \cdot \frac{100\text{k}\Omega}{R_{ext}}$$

R_{ext} is nominally 100k Ω , and provides 100 millisecond internal timing and a 1-10,000 lux range for Diode 1. Doubling this resistor value to 200k Ω halves the internal oscillator frequency, providing 200ms internal timing. In addition, the maximum lux range of Diode 1 is also halved, from 10,000 lux to 5,000 lux, and the resolution is doubled, from 3.3 counts per lux to 6.6 counts per lux.

The acceptable range of this resistor is 50k Ω (providing 50ms internal timing, 100,000 lux maximum reading, ~1.6 counts per lux) to 500k Ω (500ms internal timing, 2,000 lux maximum reading, ~16 counts per lux).

When using one of the three internal timing modes, the ISL29001's resolution is determined by the ratio of the max lux range to 32,768, the number of clock cycles per integration.

The following equations describe the light intensity as a function of the sensor reading, and the integration time as a function of the external resistor.

$$L = \frac{1}{32768} \cdot \frac{10,000\text{lux}}{(R_{\text{ext}}/100\text{k}\Omega)} \cdot \text{Data1}$$

$$T = 100\text{ms} \cdot \frac{R_{\text{ext}}}{100\text{k}\Omega}$$

where L is the measured light intensity, Data1 is the sensor reading, T is the integration time, and R_{ext} is external resistor value.

External Timing

When using one of the three external timing modes, each integration period of the ISL29001 is determined by the time which passes between consecutive external timing commands received over the I²C bus.

The internal oscillator operates identically in both the internal and external timing modes, with the same dependence on R_{ext} . However, when using one of the three external timing modes, the number of clock cycles per integration is no

longer fixed at 32,768, but varies with the chosen integration time.

The number of clock cycles in the previous integration period is provided in the third and fourth bytes of data read across the I²C bus. This two-byte value is called the integration counter value.

When using one of the three external timing modes, the ISL29001's resolution varies with the integration time. The resolution is determined by the ratio of the max lux range to the number of clock cycles per integration.

The following equations describe the light intensity as a function of sensor reading, integration counter value, and integration time:

$$L = \frac{10,000\text{lux}}{(R_{\text{ext}}/100\text{k}\Omega)} \cdot \frac{\text{Data1}}{\text{Data2}}$$

$$T = \text{Time Interval between external time commands}$$

where L is the measured light intensity, Data1 is the sensor reading, Data2 is the integration counter value, T is the integration time, and R_{ext} is external resistor value.

Typical Circuit

A typical application circuit is shown in Figure 12.

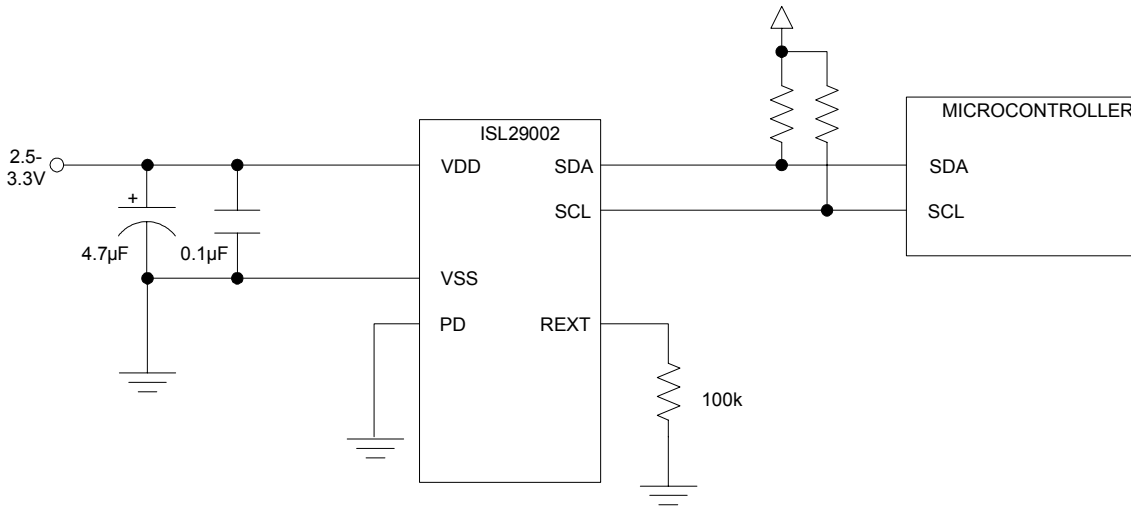

FIGURE 12. TYPICAL CIRCUIT

Suggested PCB Footprint

See Figure 13. Footprint pads should be a nominal 1-to-1 correspondence with package pads. The large, exposed central die-mounting paddle in the center of the package requires neither thermal nor electrical connection to the PCB, and such connection should be avoided.

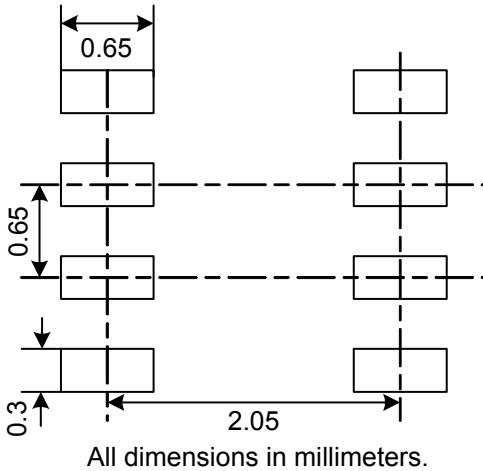

FIGURE 13. SUGGESTED PCB FOOTPRINT

Layout Considerations

The ISL29001 is relatively insensitive to layout. Like other I²C devices, it is intended to provide excellent performance even in significantly noisy environments. There are only a few considerations that will ensure best performance.

Route the supply and I²C traces as far as possible from all sources of noise. Use two power-supply decoupling capacitors, 4.7 μ F and 0.1 μ F, placed close to the device.

Soldering Considerations

Convection heating is recommended for reflow soldering; direct-infrared heating is not recommended. The ISL29001's plastic ODFN package does not require a custom reflow soldering profile, and is qualified to 260°C. A standard reflow soldering profile with a 260°C maximum is recommended.

ODFN Package Outline Drawing

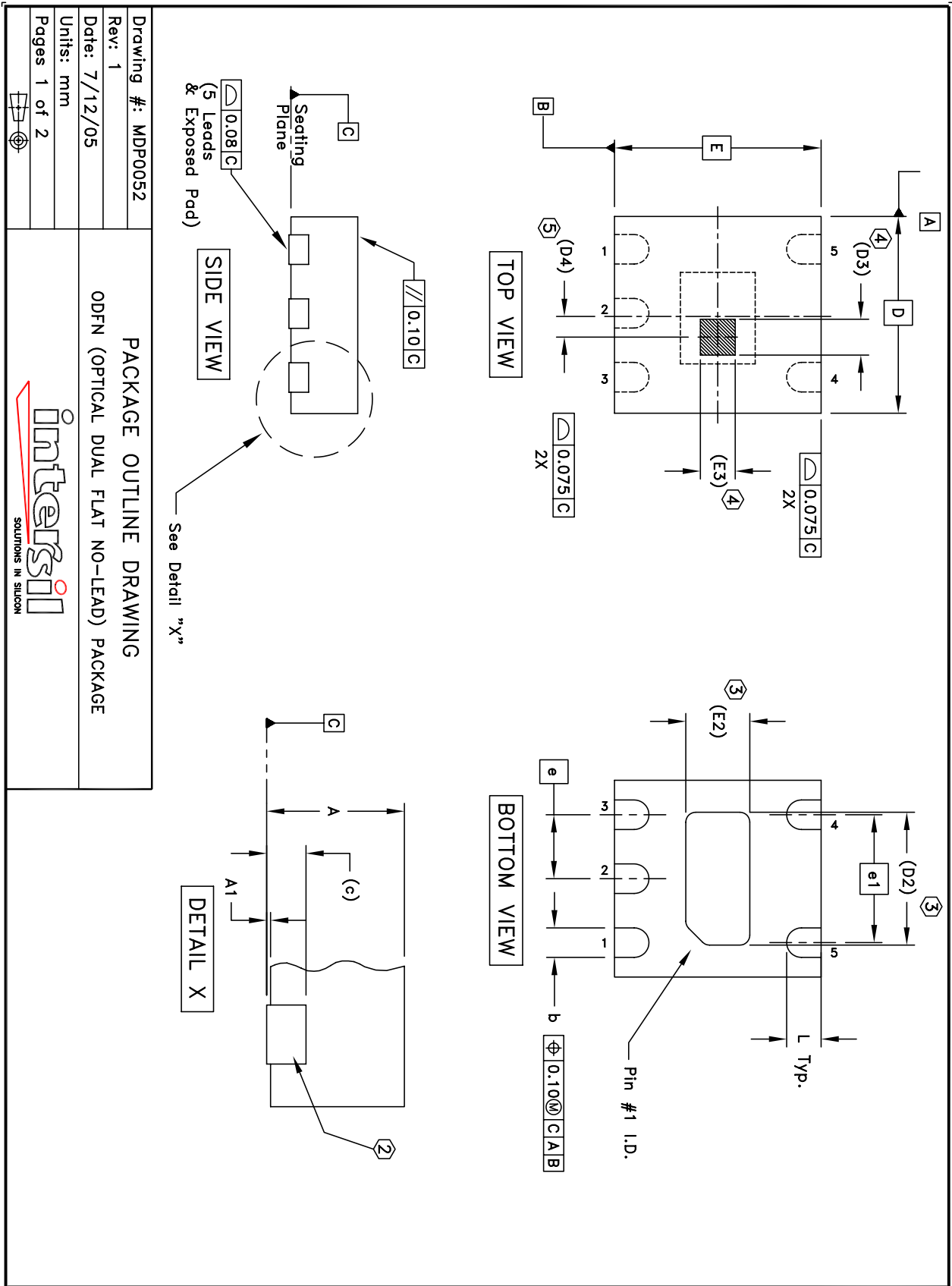

DIMENSION TABLE				
Symbol	ODFN5	ODFN6	ODFN8	Tolerance Note
A	0.70	0.70	0.70	±0.05
A1	0.02	0.02	0.02	+0.03/-0.02
D	2.00	2.00	3.00	Basic
D2	1.35	1.35	2.29	Reference ③
D3	0.36	0.61	0.61	Reference ④
D4	0.21	0.25	0.25	Reference ⑤
E	2.10	2.10	3.00	Basic
E2	0.65	0.65	1.40	Reference ③
E3	0.35	0.43	0.43	Reference ④
L	0.35	0.35	0.40	±0.05
b	0.30	0.30	0.30	±0.05
c	0.20	0.20	0.20	Reference
e	0.65	0.65	0.65	Basic
e1	1.30	1.30	1.95	Basic

Notes:

- ① Dimensioning and tolerancing per ASME Y14.5M-1994.
- ② Exposed lead at side of package is a non-functional feature.
- ③ Dimension D2 & E2 define the size of the exposed pad
- ④ Dimension D3 & E3 define the SIZE of the light-sensitive (photo diode) area.
- ⑤ Dimension D4 defines the LOCATION of the light-sensitive area. It shows the distance from the package center to the center of the photo diode.

Drawing #: MDP0052

Rev: 1

Date: 7/12/05

Pages 2 of 2

PACKAGE OUTLINE DRAWING

ODFN (OPTICAL DUAL FLAT NO-LEAD) PACKAGE

All Intersil U.S. products are manufactured, assembled and tested utilizing ISO9000 quality systems. Intersil Corporation's quality certifications can be viewed at www.intersil.com/design/quality

Intersil products are sold by description only. Intersil Corporation reserves the right to make changes in circuit design, software and/or specifications at any time without notice. Accordingly, the reader is cautioned to verify that data sheets are current before placing orders. Information furnished by Intersil is believed to be accurate and reliable. However, no responsibility is assumed by Intersil or its subsidiaries for its use; nor for any infringements of patents or other rights of third parties which may result from its use. No license is granted by implication or otherwise under any patent or patent rights of Intersil or its subsidiaries.

For information regarding Intersil Corporation and its products, see www.intersil.com