

# High-side Power Switch with Diagnostic Function SI-5155S

## Features

- Built-in diagnostic function to detect short and open circuiting of loads and output status signals
- Low saturation PNP transistor use
- Allows direct driving using LS-TTL and C-MOS logic levels
- Built-in overcurrent and thermal protection circuits
- Built-in protection against reverse connection of power supply
- $T_j = 150^\circ\text{C}$  guaranteed
- TO-220 equivalent full-mold package not require insulation mica

## Absolute Maximum Ratings

( $T_a = 25^\circ\text{C}$ )

Parameter	Symbol	Ratings	Unit	Conditions
Power supply voltage	$V_B$	-13 to +40	V	
Input terminal voltage	$V_{IN}$	-0.3 to $V_B$	V	
DIAG terminal voltage	$V_{DIAG}$	6	V	
Collector-emitter voltage	$V_{CE}$	40	V	
Output current	$I_O$	2.5	A	
Power dissipation	$P_{D1}$	22	W	With infinite heatsink ( $T_c = 25^\circ\text{C}$ )
	$P_{D2}$	1.8	W	Stand-alone without heatsink
Junction temperature	$T_j$	-40 to +150	$^\circ\text{C}$	
Operating temperature	$T_{OP}$	-40 to +100	$^\circ\text{C}$	
Storage temperature	$T_{stg}$	-40 to +150	$^\circ\text{C}$	

## Electrical Characteristics

( $T_a = 25^\circ\text{C}$  unless otherwise specified)

Parameter	Symbol	Ratings			Unit	Conditions	
		min	typ	max			
Operating power supply voltage	$V_{Bopr}$	6.0		30	V		
Quiescent circuit current	$I_q$		5	12	mA	$V_{Bopr} = 14\text{V}$ , $V_{IN} = 0\text{V}$	
Saturation voltage of output transistor	$V_{CE(sat)}$			0.3	V	$I_O \leq 1.0\text{A}$ , $V_{Bopr} = 6$ to $16\text{V}$	
				0.72	V	$I_O \leq 2.5\text{A}$ , $V_{Bopr} = 6$ to $16\text{V}$	
Output leak current	$I_{o, leak}$			2	mA	$V_{CE0} = 16\text{V}$ , $V_{IN} = 0\text{V}$	
Input voltage	Output ON	$V_{IH}$	2.0		$V_B$	V	$V_{Bopr} = 6$ to $16\text{V}$
	Output OFF	$V_{IL}$	-0.3		0.8	V	$V_{Bopr} = 6$ to $16\text{V}$
Input current	Output ON	$I_{IH}$			1	mA	$V_{IN} = 5\text{V}$
	Output OFF	$I_{IL}$	-0.1			mA	$V_{IN} = 0\text{V}$
Overcurrent protection starting current	$I_S$	2.6				A	$V_{Bopr} = 14\text{V}$ , $V_O = V_{Bopr} - 1.5\text{V}$
Thermal protection starting temperature	$T_{TSD}$	150				$^\circ\text{C}$	$V_{Bopr} \geq 6\text{V}$
Open load detection resistor	$R_{open}$			30	k $\Omega$	$V_{Bopr} = 6$ to $16\text{V}$	
Output transfer time	$T_{ON}$		8	30	$\mu\text{s}$	$V_{Bopr} = 14\text{V}$ , $I_O = 1\text{A}$	
	$T_{OFF}$		15	30	$\mu\text{s}$	$V_{Bopr} = 14\text{V}$ , $I_O = 1\text{A}$	
DIAG output voltage	$V_{DH}$	4.5		6	V	$V_{CC} = 6\text{V}$ , $V_{Bopr} = 6$ to $16\text{V}$	
	$V_{DL}$			0.3	V	$V_{CC} = 6\text{V}$ , $V_{Bopr} = 6$ to $16\text{V}$ , $I_O = 2\text{mA}$	
DIAG output transfer time	$T_{PLH}$			30	$\mu\text{s}$	$V_{Bopr} = 14\text{V}$ , $I_O = 1\text{A}$	
	$T_{PHL}$			30	$\mu\text{s}$	$V_{Bopr} = 14\text{V}$ , $I_O = 1\text{A}$	
Minimum load inductance	L	1			mH		

Note:

\* The rule of protection against reverse connection of power supply is  $V_B = -13\text{V}$ , one minute (all terminals except,  $V_B$  and GND, are open).

## External Dimensions (unit: mm)

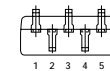
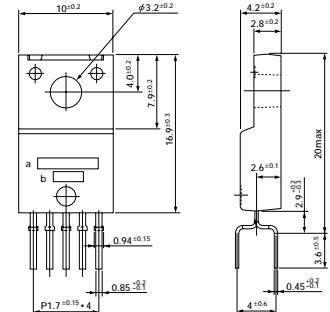

1. GND
  2.  $V_{IN}$
  3.  $V_O$
  4. DIAG
  5.  $V_B$
- a: Type No.  
b: Lot No.

(Forming No. 1111)

## Standard Circuit Diagram

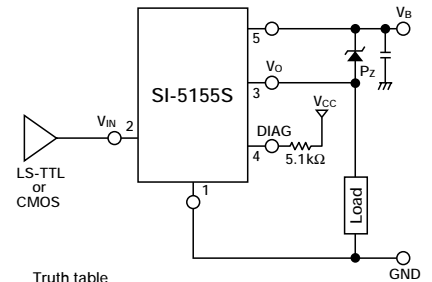

Truth table

$V_{IN}$	$V_O$
H	H
L	L

## Diagnostic Function

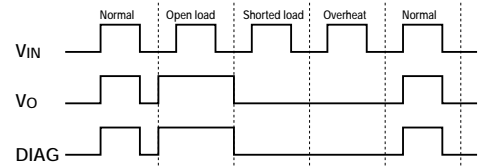

Mode	$V_{IN}$	$V_O$	DIAG
Normal	L	L	L
	H	H	H
Open load	L	H	H
	H	H	H
Shorted load	L	L	L
	H	L	L
Overheat	L	L	L
	H	L	L

- DIAG output will be undetermined when a voltage exceeding 25V is applied to  $V_B$  terminal.

■ Quiescent Circuit Current

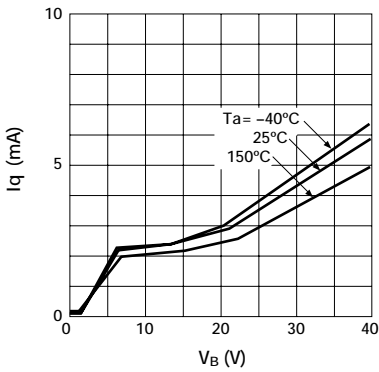

■ Circuit Current

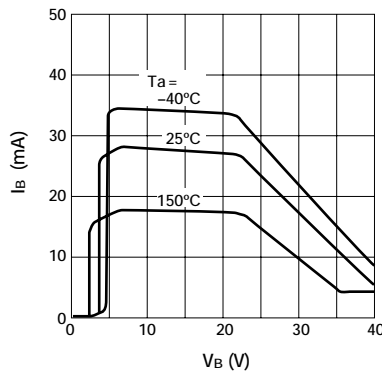

■ Saturation Voltage of Output Transistor

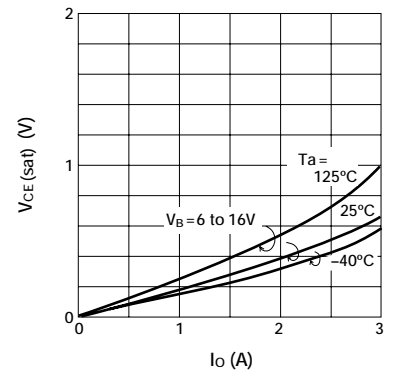

■ Overcurrent Protection Characteristics ( $T_a = -40^\circ\text{C}$ )

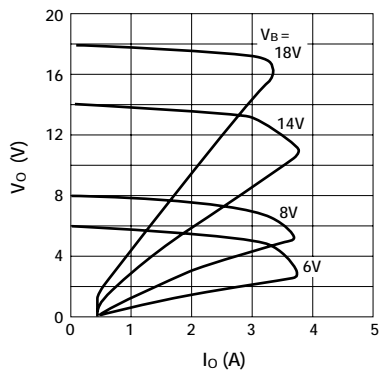

■ Overcurrent Protection Characteristics ( $T_a = 25^\circ\text{C}$ )

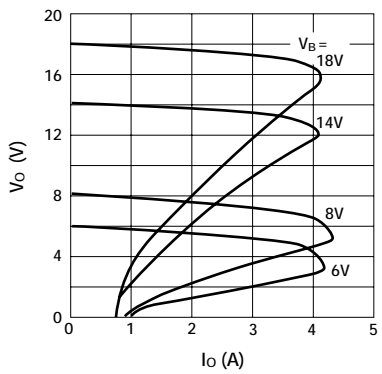

■ Overcurrent Protection Characteristics ( $T_a = 125^\circ\text{C}$ )

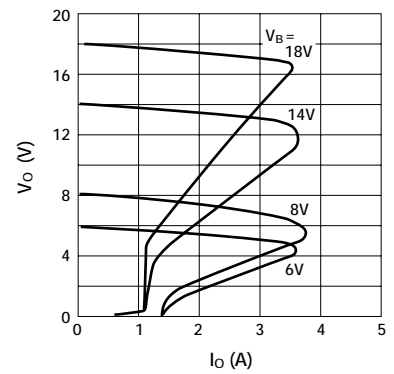

■ Threshold input voltage

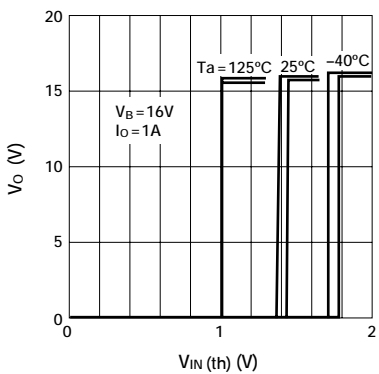

■ Input Current (Output ON)

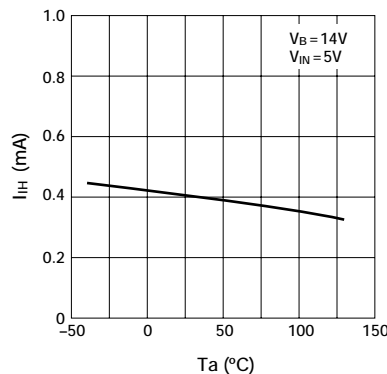

■ Input Current (Output OFF)

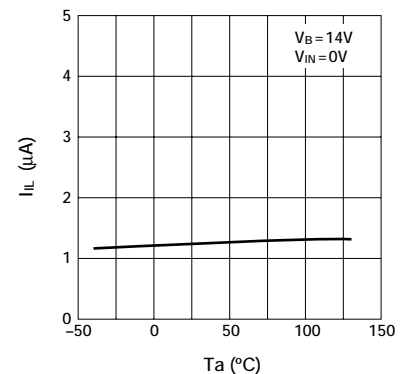

■ Output Terminal Leak Current

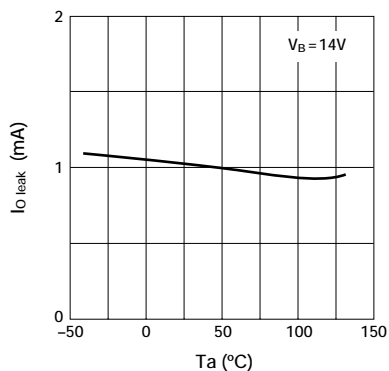

■ Saturation Voltage of DIAG Output

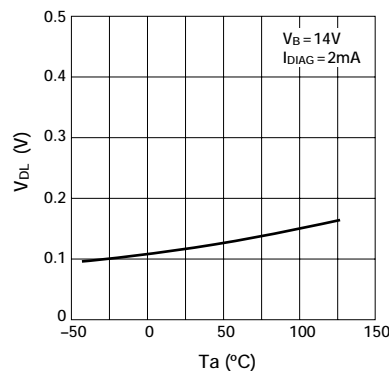

■ Thermal Protection Characteristics

