

1N6821
(MSASC150H45L)
1N6821R
(MSASC150H45LR)

45 Volts
150 Amps

LOW VOLTAGE
DROP SCHOTTKY
DIODE

Features

- Tungsten/Platinum schottky barrier
- Oxide passivated structure for very low leakage currents
- Guard ring protection for increased reverse energy capability
- Epitaxial structure minimizes forward voltage drop
- Hermetically sealed, low profile ceramic surface mount power package
- Low package inductance
- Very low thermal resistance
- Available as standard polarity (strap-to-anode, 1N6821) and reverse polarity (strap-to-cathode: 1N6821R)

Maximum Ratings @ 25°C (unless otherwise specified)

DESCRIPTION	SYMBOL	MAX.	UNIT
Peak Repetitive Reverse Voltage	V_{RRM}	45	Volts
Working Peak Reverse Voltage	V_{RWM}	45	Volts
DC Blocking Voltage	V_R	45	Volts
Average Rectified Forward Current, $T_c \leq 125^\circ\text{C}$	$I_{F(ave)}$	150	Amps
derating, forward current, $T_c \geq 125^\circ\text{C}$	di_F/dT	4	Amps/ $^\circ\text{C}$
Nonrepetitive Peak Surge Current, $t_p = 8.3$ ms, half-sinewave	I_{FSM}	750	Amps
Peak Repetitive Reverse Surge Current, $t_p = 1\mu\text{s}$, $f = 1\text{kHz}$	I_{RRM}	2	Amp
Junction Temperature Range	T_j	-55 to +150	$^\circ\text{C}$
Storage Temperature Range	T_{stg}	-55 to +150	$^\circ\text{C}$
Thermal Resistance, Junction to Case:			$^\circ\text{C/W}$
	1N6821	0.20	
	1N6821R	0.35	

Mechanical Outline
ThinKey™3

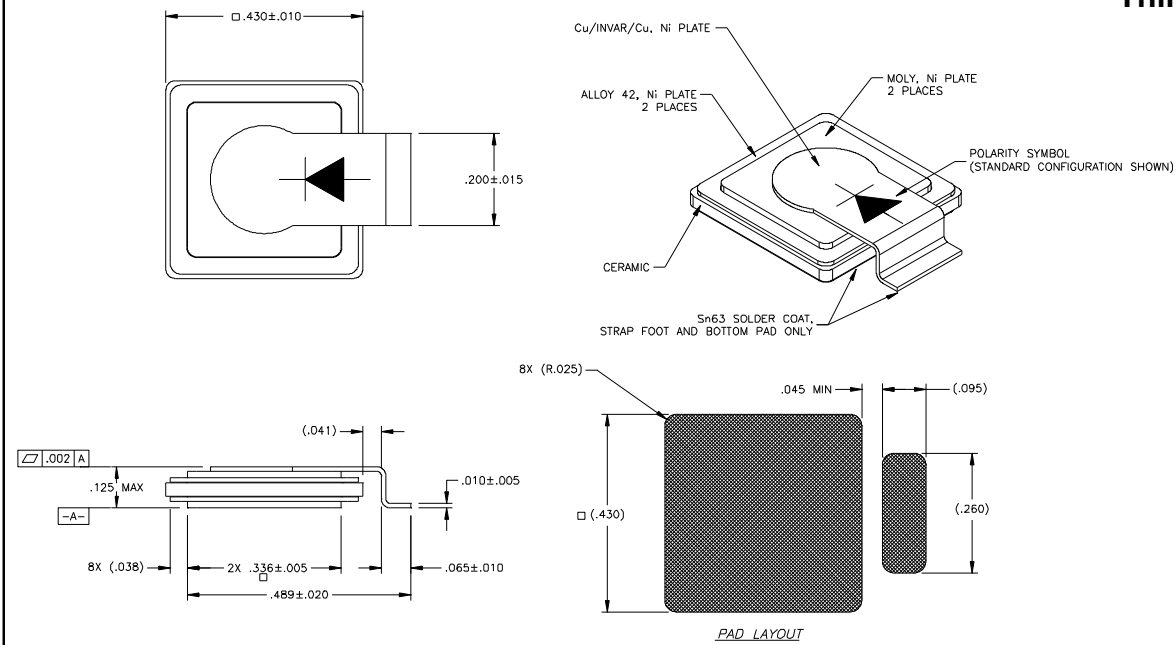

1N6821 (MSASC150H45L) 1N6821R (MSASC150H45LR)

Electrical Parameters

DESCRIPTION	SYMBOL	CONDITIONS	MIN	TYP.	MAX	UNIT
Reverse (Leakage) Current	IR ₂₅	VR= 45 Vdc, Tc= 25°C		1	10	mA
	IR ₁₀₀	VR= 45 Vdc, Tc= 100°C		125	300	mA
	IR ₁₂₅	VR= 45 Vdc, Tc= 125°C		500		mA
Forward Voltage pulse test, pw= 300 μs d/c≤ 2%	VF1	IF= 20A, Tc= 25°C		340	370	mV
	VF2	IF= 50A, Tc= 25°C		410	450	mV
	VF3	IF= 100A, Tc= 25°C		475	530	mV
	VF4	IF= 150A, Tc= 25°C		540	600	mV
	VF5	IF= 200A, Tc= 25°C		600		mV
	VF6	IF= 50A, Tc= -55°C		470	550	mV
	VF7	IF= 50A, Tc= 125°C		315	380	mV
	VF8	IF= 100A, Tc= 125°C		415		mV
	VF9	IF= 150A, Tc= 100°C		515		mV
	VF10	IF= 10 mA, Tc= 25°C		135	-	mV
	VF11	IF= 50 mA, Tc= 25°C		175	-	mV
	VF12	IF= 100 mA, Tc= 25°C		195	-	mV
Junction Capacitance	Cj1	VR= 10 Vdc		4500	4900	pF
	Cj2	VR= 5 Vdc		6400		pF
Breakdown Voltage	BVR	IR= 5 mA, Tc= 25°C		55		V
		IR= 5 mA, Tc= -55°C	45	50		V

Typical VF data, msasc150h45

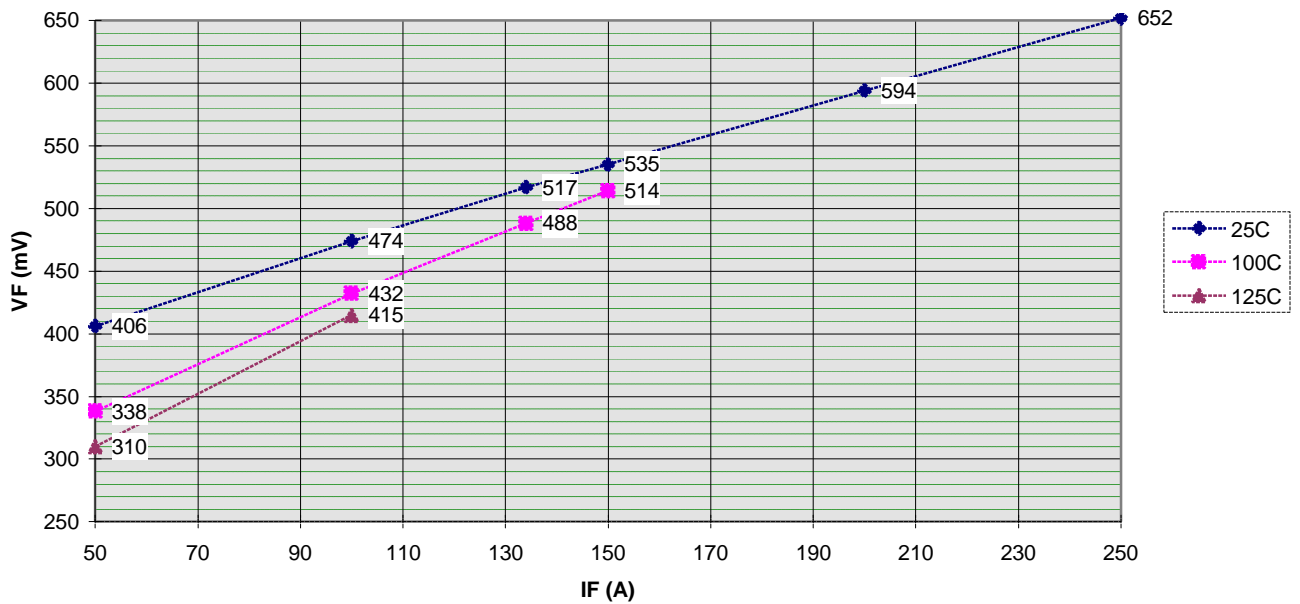

1N6821 (MSASC150H45L)
1N6821R (MSASC150H45LR)

Cj vs VR Typical Curve

