

T-39-11

INTERNATIONAL RECTIFIER

INTERNATIONAL RECTIFIER 

**HEXFET<sup>®</sup> TRANSISTORS**

**IRFZ30**

**N-Channel  
50 VOLT  
POWER MOSFETs**

**IRFZ32**

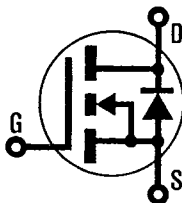

**50 Volt, 0.05 Ohm HEXFET  
TO-220AB Plastic Package**

The HEXFET technology has expanded its product base to serve the low voltage, very low  $R_{DS(on)}$  MOSFET transistor requirements. International Rectifier's highly efficient geometry and unique processing of the HEXFET have been combined to create the lowest on resistance per device performance. In addition to this feature all HEXFETs have documented reliability and parts per million quality!

The HEXFET transistors also offer all of the well established advantages of MOSFETs such as voltage control, very fast switching, ease of paralleling, and temperature stability of the electrical parameters.

They are well suited for applications such as switching power supplies, motor controls, inverters, choppers, audio amplifiers, high energy pulse circuits, and in systems that are operated from low voltage batteries, such as automotive, portable equipment, etc.

**Product Summary**

Part Number	$V_{DS}$	$R_{DS(on)}$	$I_D$
IRFZ30	50V	0.05Ω	30A
IRFZ32	50V	0.07Ω	25A



**Features:**

- Extremely Low  $R_{DS(on)}$
- Compact Plastic Package
- Fast Switching
- Low Drive Current
- Ease of Paralleling
- Excellent Temperature Stability
- Parts Per Million Quality

**CASE STYLE AND DIMENSIONS**

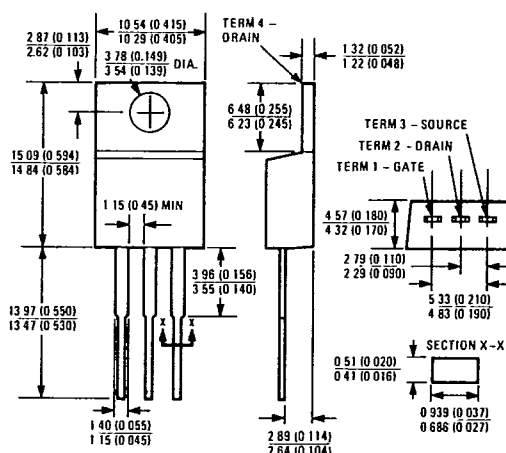
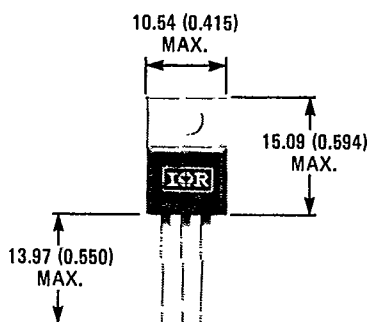

Case Style TO-220AB  
Dimensions in Millimeters and (Inches)

**Absolute Maximum Ratings**

Parameter	IRFZ30	IRFZ32	Units
V <sub>DS</sub> Drain - Source Voltage ①	50	50	V
V <sub>DGR</sub> Drain - Gate Voltage (R <sub>GS</sub> = 20 KΩ) ①	50	50	V
I <sub>D</sub> @ T <sub>C</sub> = 25°C Continuous Drain Current	30	25	A
I <sub>D</sub> @ T <sub>C</sub> = 100°C Continuous Drain Current	19	16	A
I <sub>DM</sub> Pulsed Drain Current ③	80	60	A
V <sub>GS</sub> Gate - Source Voltage	±20		V
P <sub>D</sub> @ T <sub>C</sub> = 25°C Max. Power Dissipation	75 (See Fig. 14)		W
Linear Derating Factor	0.6 (See Fig. 14)		W/K ④
I <sub>LM</sub> Inductive Current, Clamped	(See Fig. 15 and 16) L = 100μH		A
T <sub>J</sub> Operating Junction and Storage Temperature Range	-55 to 150		°C
T <sub>stg</sub> Lead Temperature	300 (0.063 in. (1.6mm) from case for 10s)		°C

**Electrical Characteristics @ T<sub>C</sub> = 25°C (Unless Otherwise Specified)**

Parameter	Type	Min.	Typ.	Max.	Units	Test Conditions
BV <sub>DSS</sub> Drain - Source Breakdown Voltage	IRFZ30	50	—	—	V	V <sub>GS</sub> = 0V
	IRFZ32	50	—	—	V	I <sub>D</sub> = 250 μA
V <sub>GS(th)</sub> Gate Threshold Voltage	ALL	2.0	—	4.0	V	V <sub>DS</sub> = V <sub>GS</sub> , I <sub>D</sub> = 250 μA
I <sub>GSS</sub> Gate-Source Leakage Forward	ALL	—	—	500	nA	V <sub>GS</sub> = 20V
I <sub>GSS</sub> Gate-Source Leakage Reverse	ALL	—	—	-500	nA	V <sub>GS</sub> = -20V
I <sub>DSS</sub> Zero Gate Voltage Drain Current	ALL	—	—	250	μA	V <sub>DS</sub> = Max. Rating, V <sub>GS</sub> = 0V
		—	—	1000	μA	V <sub>DS</sub> = Max. Rating × 0.8, V <sub>GS</sub> = 0V, T <sub>C</sub> = 125°C
I <sub>D(on)</sub> On-State Drain Current ②	IRFZ30	30	—	—	A	V <sub>DS</sub> > I <sub>D(on)</sub> × R <sub>DS(on)max.</sub> , V <sub>GS</sub> = 10V
	IRFZ32	25	—	—	A	
R <sub>DS(on)</sub> Static Drain-Source On-State Resistance ②	IRFZ30	—	0.045	0.050	Ω	V <sub>GS</sub> = 10V, I <sub>D</sub> = 16A
	IRFZ32	—	0.065	0.070	Ω	
g <sub>fs</sub> Forward Transconductance ②	ALL	9.0	12	—	S(t)	V <sub>DS</sub> > I <sub>D(on)</sub> × R <sub>DS(on)max.</sub> , I <sub>D</sub> = 16A
C <sub>iss</sub> Input Capacitance	ALL	—	1250	1600	pF	V <sub>GS</sub> = 0V, V <sub>DS</sub> = 25V, f = 1.0 MHz
C <sub>oss</sub> Output Capacitance	ALL	—	550	800	pF	See Fig. 10
C <sub>rss</sub> Reverse Transfer Capacitance	ALL	—	130	200	pF	
t <sub>d(on)</sub> Turn-On Delay Time	ALL	—	12	25	ns	V <sub>DD</sub> ≈ 25V, I <sub>D</sub> = 16A, Z <sub>0</sub> = 50Ω
t <sub>r</sub> Rise Time	ALL	—	16	35	ns	See Fig. 17
t <sub>d(off)</sub> Turn-Off Delay Time	ALL	—	23	45	ns	(MOSFET switching times are essentially independent of operating temperature.)
t <sub>f</sub> Fall Time	ALL	—	16	35	ns	
Q <sub>g</sub> Total Gate Charge (Gate-Source Plus Gate-Drain)	ALL	—	26	30	nC	V <sub>GS</sub> = 10V, I <sub>D</sub> = 38A, V <sub>DS</sub> = 0.8 Max. Rating. See Fig. 18 for test circuit. (Gate charge is essentially independent of operating temperature.)
	ALL	—	14	—	nC	
	ALL	—	12	—	nC	
L <sub>D</sub> Internal Drain Inductance	—	—	3.5	—	nH	Measured from the contact screw on tab to center of dia.
	ALL	—	4.5	—	nH	
L <sub>S</sub> Internal Source Inductance	ALL	—	7.5	—	nH	Measured from the source lead, 6mm (0.25 in.) from package to source bonding pad.

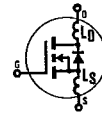

**Thermal Resistance**

R <sub>thJC</sub> Junction-to-Case	ALL	—	—	1.67	K/W ④	
R <sub>thCS</sub> Case-to-Sink	ALL	—	1.0	—	K/W ④	Mounting surface flat, smooth, and greased.
R <sub>thJA</sub> Junction-to-Ambient	ALL	—	—	80	K/W ④	Typical socket mount

Source-Drain Diode Ratings and Characteristics

$I_S$	Continuous Source Current (Body Diode)	IRFZ30	—	—	30	A	Modified MOSFET symbol showing the integral reverse P-N junction rectifier. 	
		IRFZ32	—	—	25	A		
$I_{SM}$	Pulse Source Current (Body Diode) ③	IRFZ30	—	—	80	A		
		IRFZ32	—	—	60	A		
$V_{SD}$	Diode Forward Voltage ②	IRFZ30	—	—	1.6	V		$T_C = 25^\circ\text{C}, I_S = 30\text{A}, V_{GS} = 0\text{V}$
		IRFZ32	—	—	1.5	V		$T_C = 25^\circ\text{C}, I_S = 25\text{A}, V_{GS} = 0\text{V}$
$t_{rr}$	Reverse Recovery Time	ALL	—	160	—	ns	$T_J = 150^\circ\text{C}, I_F = 30\text{A}, dI_F/dt = 100\text{A}/\mu\text{s}$	
$Q_{RR}$	Reverse Recovered Charge	ALL	—	1.5	—	$\mu\text{C}$	$T_J = 150^\circ\text{C}, I_F = 30\text{A}, dI_F/dt = 100\text{A}/\mu\text{s}$	
$t_{on}$	Forward Turn-on Time	ALL	—	—	—	$\mu\text{s}$	Intrinsic turn-on time is negligible. Turn-on speed is substantially controlled by $L_S + L_D$ .	

①  $T_J = 25^\circ\text{C}$  to  $150^\circ\text{C}$ .    ② Pulse Test: Pulse width  $\leq 300\mu\text{s}$ , Duty Cycle  $\leq 2\%$ .    ③ Repetitive Rating: Pulse width limited by max. junction temperature. See Transient Thermal Impedance Curve (Fig. 5).  
 ④  $K/W = ^\circ\text{C}/\text{W}$   
 $W/K = \text{W}/^\circ\text{C}$

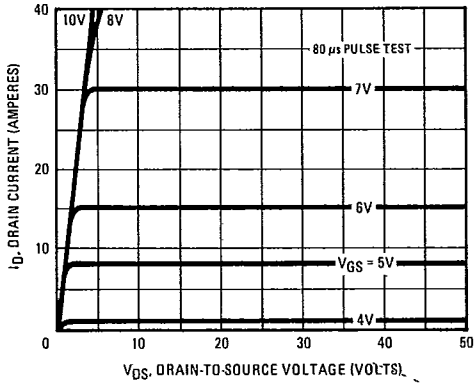

Fig. 1 - Typical Output Characteristics

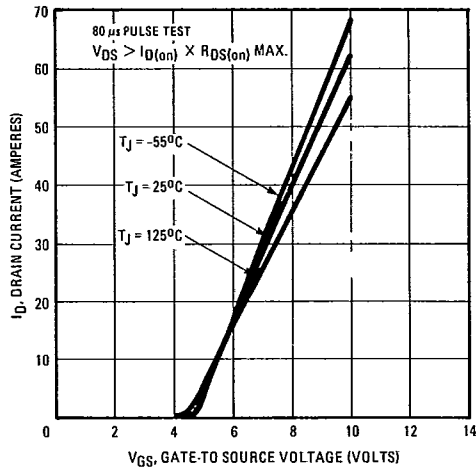

Fig. 2 - Typical Transfer Characteristics

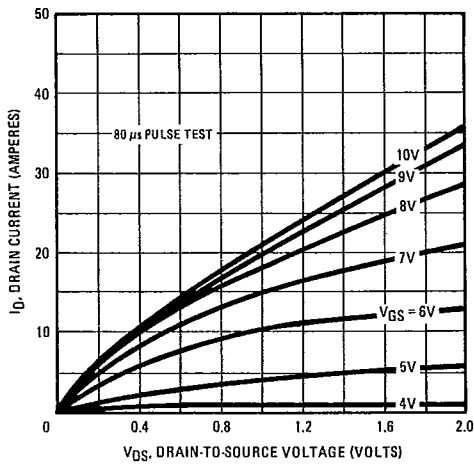

Fig. 3 - Typical Saturation Characteristics

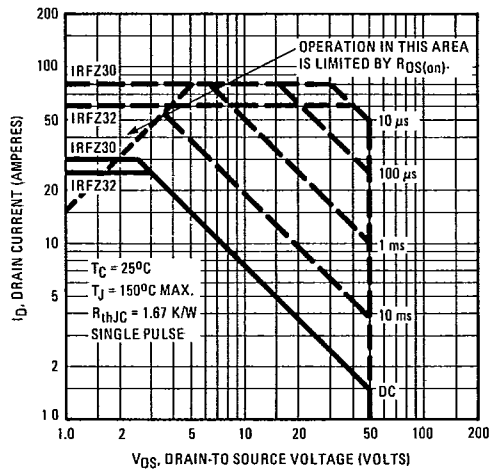

Fig. 4 - Maximum Safe Operating Area

IRFZ30, IRFZ32 Devices

INTERNATIONAL RECTIFIER

T-39-11

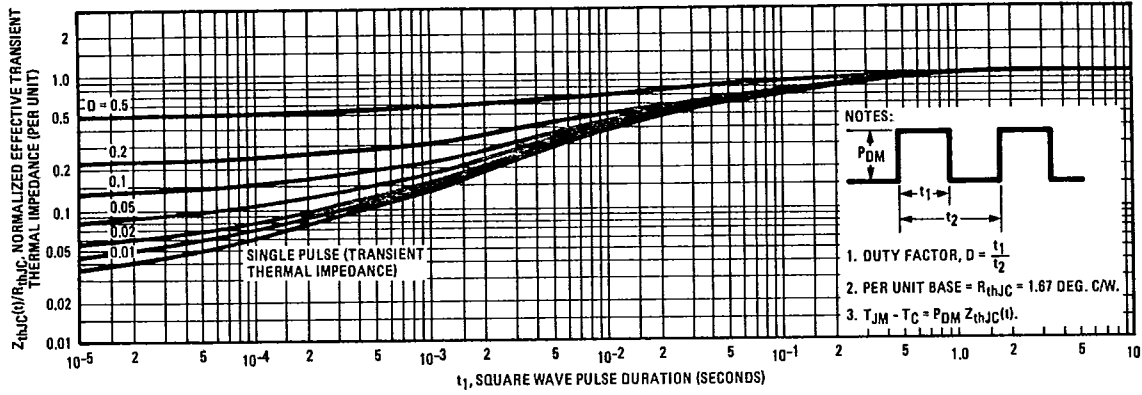

Fig. 5 – Maximum Effective Transient Thermal Impedance, Junction-to-Case Vs. Pulse Duration

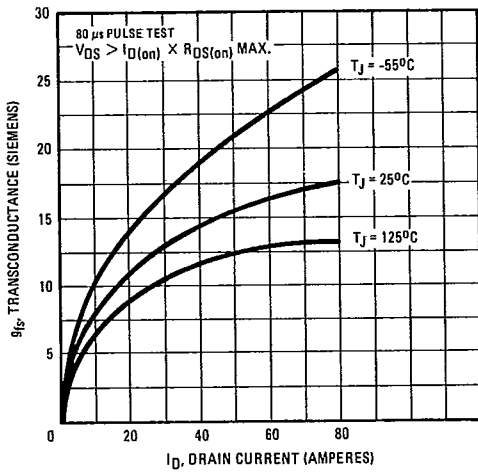

Fig. 6 Typical Transconductance Vs. Drain Current

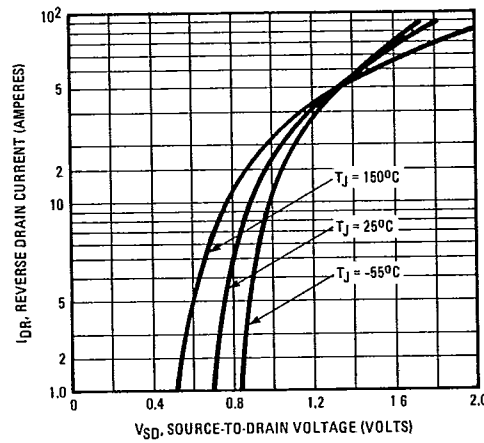

Fig. 7 – Typical Source-Drain Diode Forward Voltage

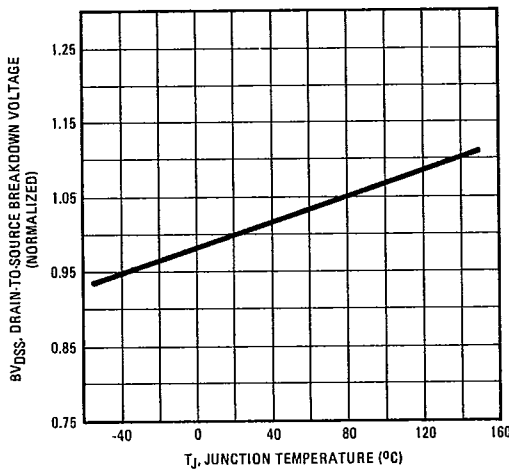

Fig. 8 – Breakdown Voltage Vs. Temperature

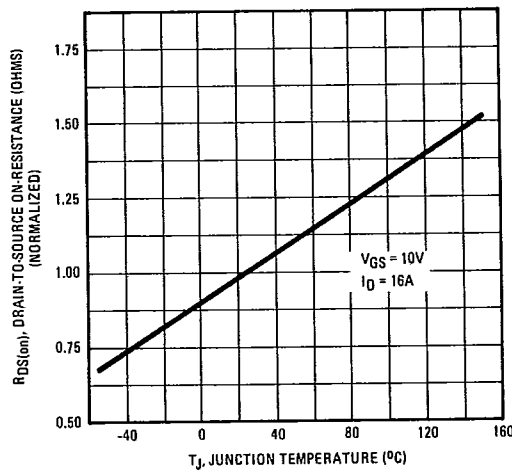

Fig. 9 – Normalized On-Resistance Vs. Temperature

INTERNATIONAL RECTIFIER

IRFZ30, IRFZ32 Devices

T-39-11

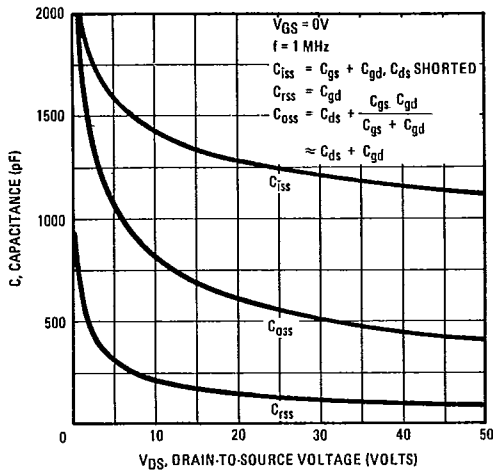

Fig. 10 - Typical Capacitance Vs. Drain-to-Source Voltage

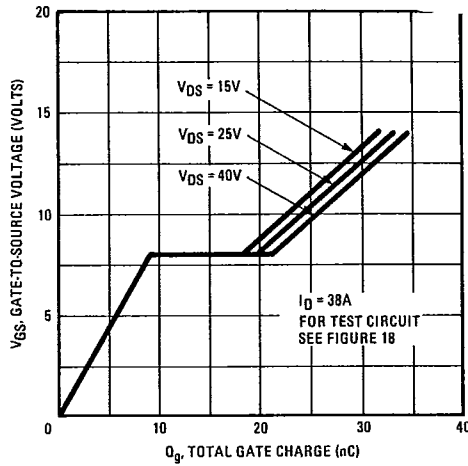

Fig. 11 - Typical Gate Charge Vs. Gate-to-Source Voltage

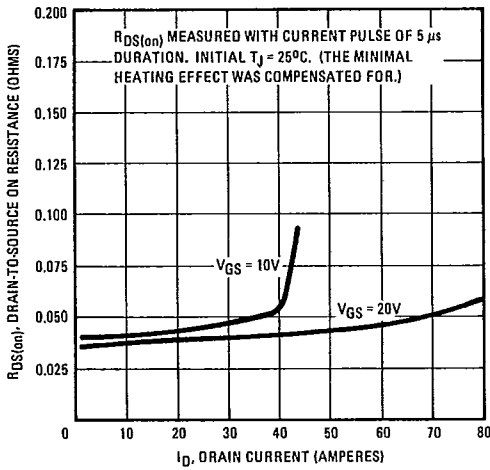

Fig. 12 - Typical On-Resistance Vs. Drain Current

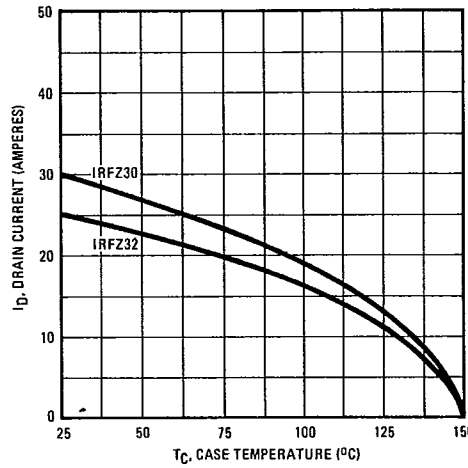

Fig. 13 - Maximum Drain Current Vs. Case Temperature

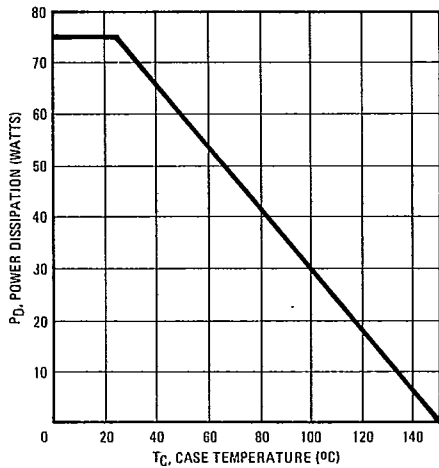

Fig. 14 - Power Vs. Temperature Derating Curve

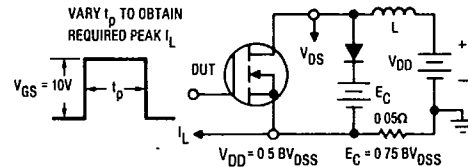

Fig. 15 - Clamped Inductive Test Circuit

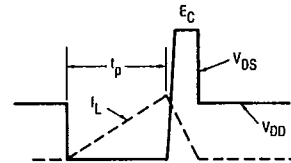

Fig. 16 - Clamped Inductive Waveforms

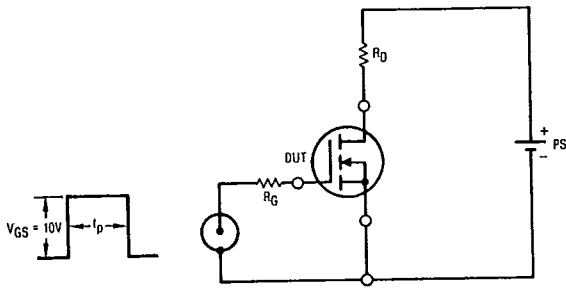

Fig. 17 — Switching Time Test Circuit

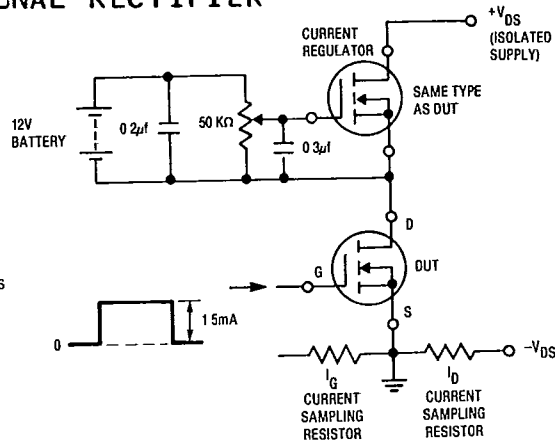
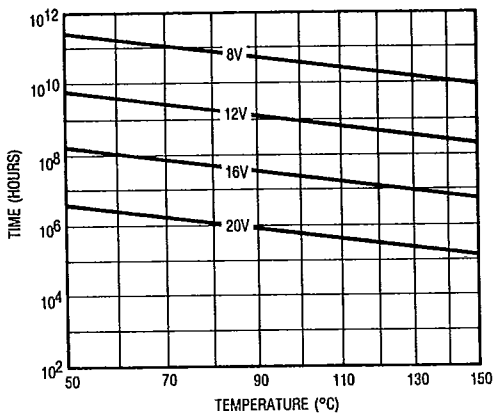
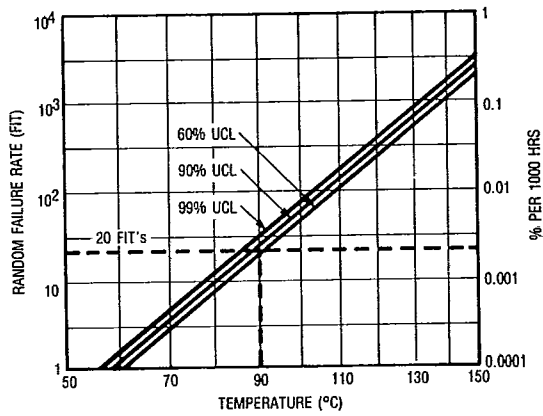

Fig. 18 — Gate Charge Test Circuit



\*Fig. 19 — Typical Time to Accumulated 1% Failure



\*Fig. 20 — Typical High Temperature Reverse Bias (HTRB) Failure Rate

\*The data shown is correct as of April 15, 1987. This information is updated on a quarterly basis; for the latest reliability data, please contact your local IR field office.