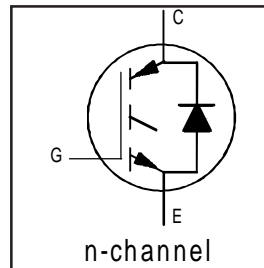


# IRG4BC15UD

INSULATED GATE BIPOLAR TRANSISTOR WITH ULTRAFAST SOFT RECOVERY DIODE UltraFast CoPack IGBT

## Features

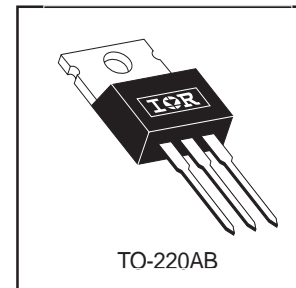
- UltraFast: Optimized for high frequencies from 10 to 30 kHz in hard switching
- IGBT Co-packaged with ultra-soft-recovery antiparallel diode
- Industry standard TO-220AB package



$V_{CES} = 600V$
$V_{CE(on)} \text{ typ.} = 2.02V$
@ $V_{GE} = 15V, I_C = 7.8A$

## Benefits

- Best Value for Appliance and Industrial Applications
- High noise immune "Positive Only" gate drive- Negative bias gate drive not necessary
- For Low EMI designs- requires little or no snubbing
- Single Package switch for bridge circuit applications
- Compatible with high voltage Gate Driver IC's
- Allows simpler gate drive



## Absolute Maximum Ratings

	Parameter	Max.	Units
$V_{CES}$	Collector-to-Emitter Voltage	600	V
$I_C @ T_C = 25^\circ C$	Continuous Collector Current	14	A
$I_C @ T_C = 100^\circ C$	Continuous Collector Current	7.8	
$I_{CM}$	Pulsed Collector Current ①	42	
$I_{LM}$	Clamped Inductive Load Current ②	42	
$I_F @ T_C = 100^\circ C$	Diode Continuous Forward Current	4.0	
$I_{FM}$	Diode Maximum Forward Current	16	
$V_{GE}$	Gate-to-Emitter Voltage	$\pm 20$	V
$P_D @ T_C = 25^\circ C$	Maximum Power Dissipation	49	W
$P_D @ T_C = 100^\circ C$	Maximum Power Dissipation	19	
$T_J$	Operating Junction and Storage Temperature Range	-55 to +150	°C
$T_{STG}$			
	Mounting Torque, 6-32 or M3 Screw.	10 lbf•in (1.1 N•m)	

## Thermal Resistance

	Parameter	Min.	Typ.	Max.	Units
$R_{\theta JC}$	Junction-to-Case - IGBT	—	—	2.7	°C/W
$R_{\theta JC}$	Junction-to-Case - Diode	—	—	7.0	
$R_{\theta CS}$	Case-to-Sink, flat, greased surface	—	0.50	—	
$R_{\theta JA}$	Junction-to-Ambient, typical socket mount	—	—	80	
Wt	Weight	—	2 (0.07)	—	g (oz)

# IRG4BC15UD

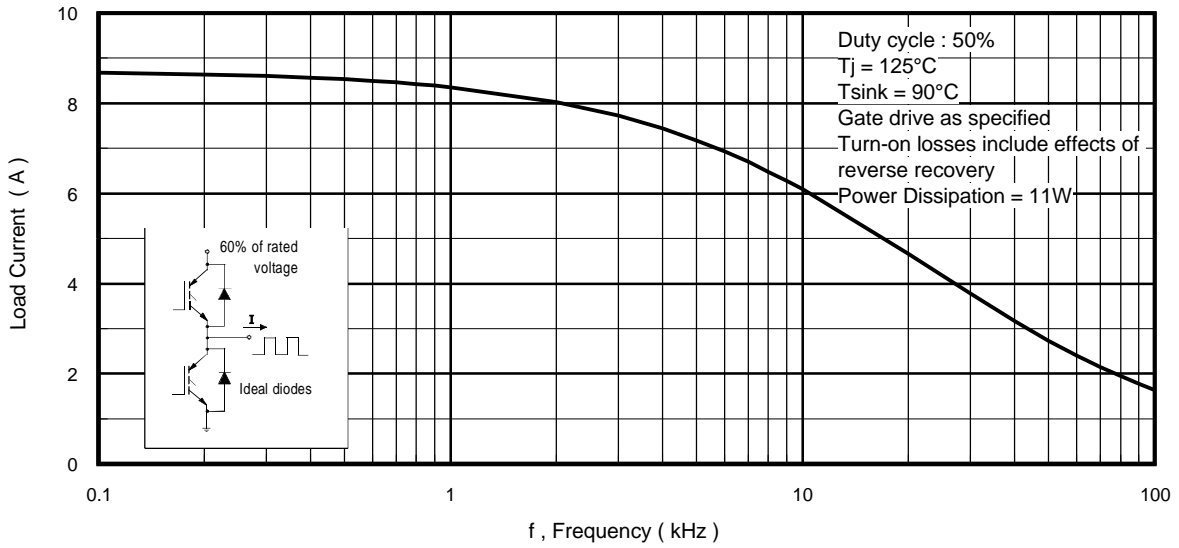
International  
**IR** Rectifier

## Electrical Characteristics @ $T_J = 25^\circ\text{C}$ (unless otherwise specified)

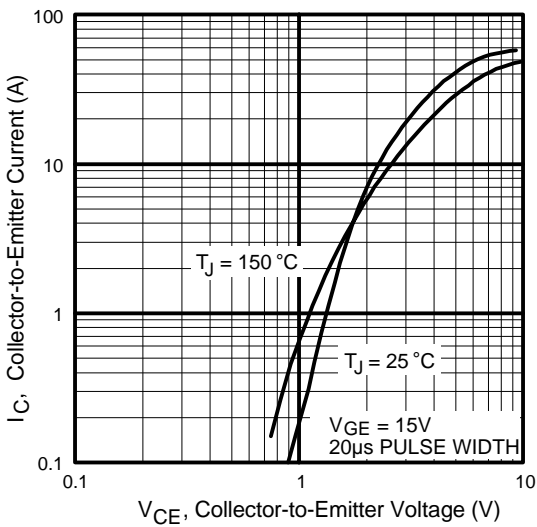
	Parameter	Min.	Typ.	Max.	Units	Conditions	
$V_{(BR)CES}$	Collector-to-Emitter Breakdown Voltage <sup>③</sup>	600	—	—	V	$V_{GE} = 0V, I_C = 250\mu A$	
$\Delta V_{(BR)CES}/\Delta T_J$	Temperature Coeff. of Breakdown Voltage	—	0.63	—	V/°C	$V_{GE} = 0V, I_C = 1.0mA$	
$V_{CE(on)}$	Collector-to-Emitter Saturation Voltage	—	2.02	2.4	V	$V_{GE} = 15V$ $I_C = 7.8A$	
		—	2.56	—			$I_C = 14A$
		—	2.21	—			$I_C = 7.8A, T_J = 150^\circ\text{C}$
$V_{GE(th)}$	Gate Threshold Voltage	3.0	—	6.0		$V_{CE} = V_{GE}, I_C = 250\mu A$	
$\Delta V_{GE(th)}/\Delta T_J$	Temperature Coeff. of Threshold Voltage	—	-10	—	mV/°C	$V_{CE} = V_{GE}, I_C = 250\mu A$	
$g_{fe}$	Forward Transconductance <sup>④</sup>	4.1	6.2	—	S	$V_{CE} = 100V, I_C = 7.8A$	
$I_{CES}$	Zero Gate Voltage Collector Current	—	—	250	$\mu A$	$V_{GE} = 0V, V_{CE} = 600V$	
		—	—	1400		$V_{GE} = 0V, V_{CE} = 600V, T_J = 150^\circ\text{C}$	
$V_{FM}$	Diode Forward Voltage Drop	—	1.5	1.8	V	$I_C = 4.0A$	
		—	1.4	1.7		$I_C = 4.0A, T_J = 150^\circ\text{C}$	
$I_{GES}$	Gate-to-Emitter Leakage Current	—	—	$\pm 100$	nA	$V_{GE} = \pm 20V$	

## Switching Characteristics @ $T_J = 25^\circ\text{C}$ (unless otherwise specified)

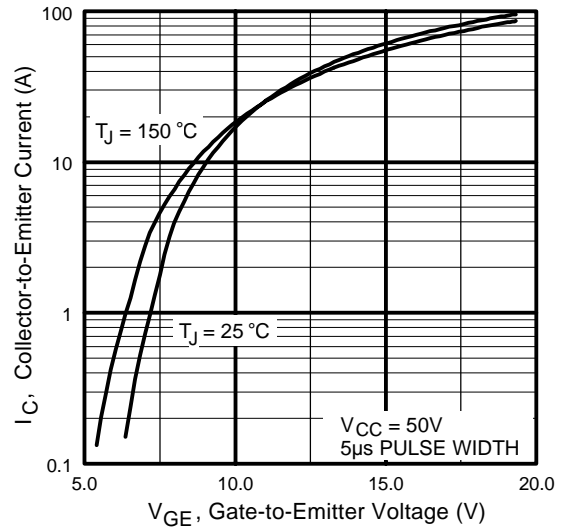
	Parameter	Min.	Typ.	Max.	Units	Conditions	
$Q_g$	Total Gate Charge (turn-on)	—	23	35	nC	$I_C = 7.8A$ $V_{CC} = 400V$ $V_{GE} = 15V$	
$Q_{ge}$	Gate - Emitter Charge (turn-on)	—	4.0	6.0			
$Q_{gc}$	Gate - Collector Charge (turn-on)	—	9.6	14			
$t_{d(on)}$	Turn-On Delay Time	—	17	—	ns	$T_J = 25^\circ\text{C}$ $I_C = 7.8A, V_{CC} = 480V$ $V_{GE} = 15V, R_G = 75\Omega$ Energy losses include "tail" and diode reverse recovery.	
$t_r$	Rise Time	—	20	—			
$t_{d(off)}$	Turn-Off Delay Time	—	160	240			
$t_f$	Fall Time	—	83	120			
$E_{on}$	Turn-On Switching Loss	—	0.24	—	mJ	$T_J = 150^\circ\text{C}$ , $I_C = 7.8A, V_{CC} = 480V$ $V_{GE} = 15V, R_G = 75\Omega$ Energy losses include "tail" and diode reverse recovery.	
$E_{off}$	Turn-Off Switching Loss	—	0.26	—			
$E_{ts}$	Total Switching Loss	—	0.50	0.63			
$t_{d(on)}$	Turn-On Delay Time	—	16	—	ns	$T_J = 150^\circ\text{C}$ , $I_C = 7.8A, V_{CC} = 480V$ $V_{GE} = 15V, R_G = 75\Omega$ Energy losses include "tail" and diode reverse recovery.	
$t_r$	Rise Time	—	21	—			
$t_{d(off)}$	Turn-Off Delay Time	—	180	—			
$t_f$	Fall Time	—	220	—			
$E_{ts}$	Total Switching Loss	—	0.76	—	mJ		
$L_E$	Internal Emitter Inductance	—	7.5	—	nH	Measured 5mm from package	
$C_{ies}$	Input Capacitance	—	410	—	pF	$V_{GE} = 0V$ $V_{CC} = 30V$ $f = 1.0MHz$	
$C_{oes}$	Output Capacitance	—	37	—			
$C_{res}$	Reverse Transfer Capacitance	—	5.3	—			
$t_{rr}$	Diode Reverse Recovery Time	—	28	42	ns	$T_J = 25^\circ\text{C}$ $T_J = 125^\circ\text{C}$	$I_F = 4.0A$ $V_R = 200V$ $di/dt 200A/\mu s$
		—	38	57			
$rr$	Diode Peak Reverse Recovery Current	—	2.9	5.2	A	$T_J = 25^\circ\text{C}$	
		—	3.7	6.7		$T_J = 125^\circ\text{C}$	
$Q_{rr}$	Diode Reverse Recovery Charge	—	40	60	nC	$T_J = 25^\circ\text{C}$	
		—	70	110		$T_J = 125^\circ\text{C}$	
$di_{(rec)M}/dt$	Diode Peak Rate of Fall of Recovery During $t_b$	—	280	—	A/ $\mu s$	$T_J = 25^\circ\text{C}$	
		—	240	—		$T_J = 125^\circ\text{C}$	



**Fig. 1** - Typical Load Current vs. Frequency  
 (Load Current =  $I_{\text{RMS}}$  of fundamental)

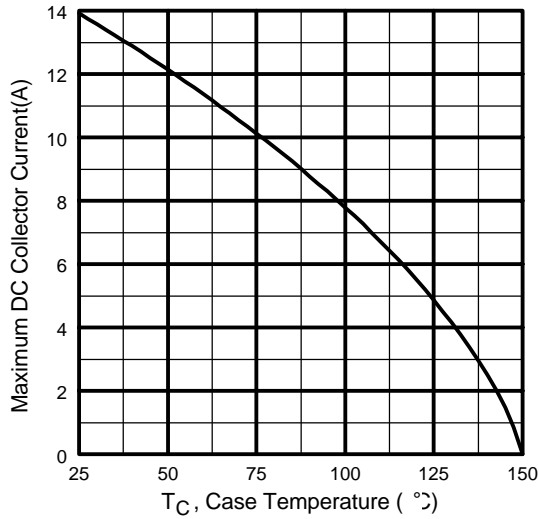


**Fig. 2** - Typical Output Characteristics

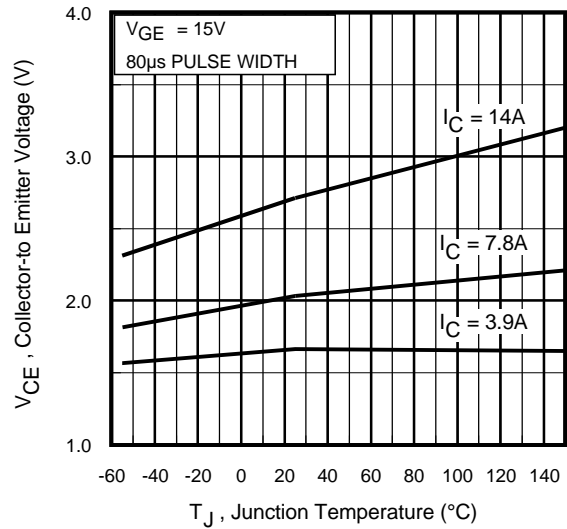


**Fig. 3** - Typical Transfer Characteristics

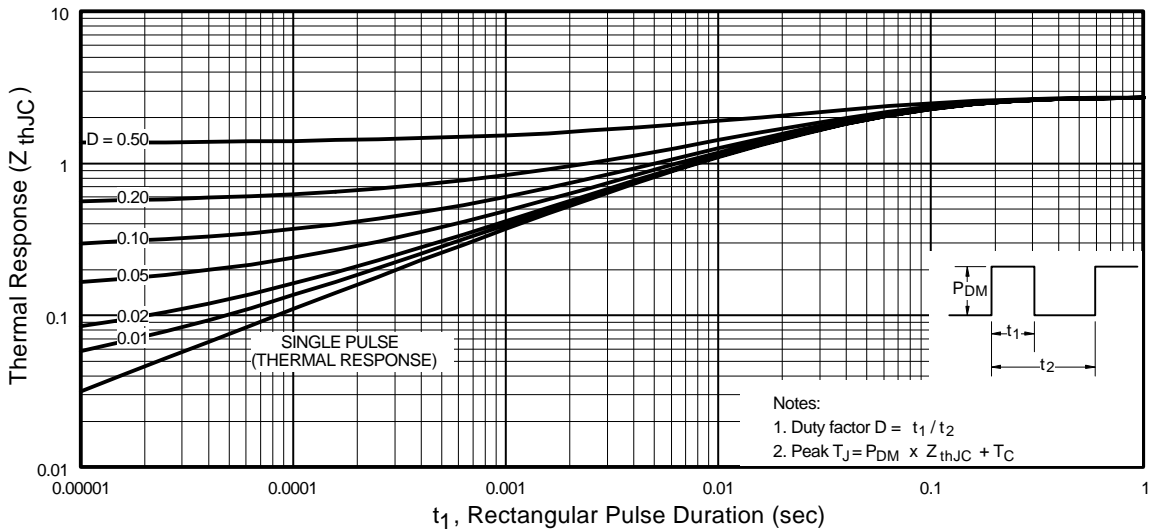
# IRG4BC15UD



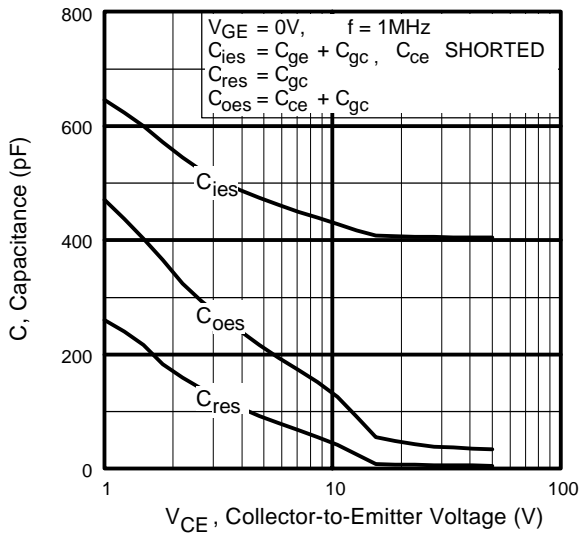
**Fig. 4** - Maximum Collector Current vs. Case Temperature



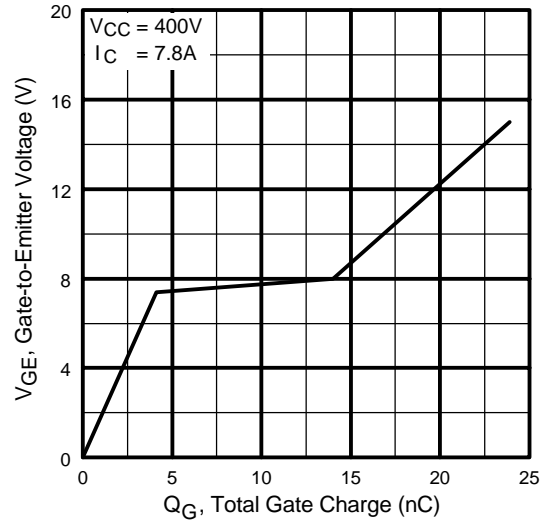
**Fig. 5** - Typical Collector-to-Emitter Voltage vs. Junction Temperature



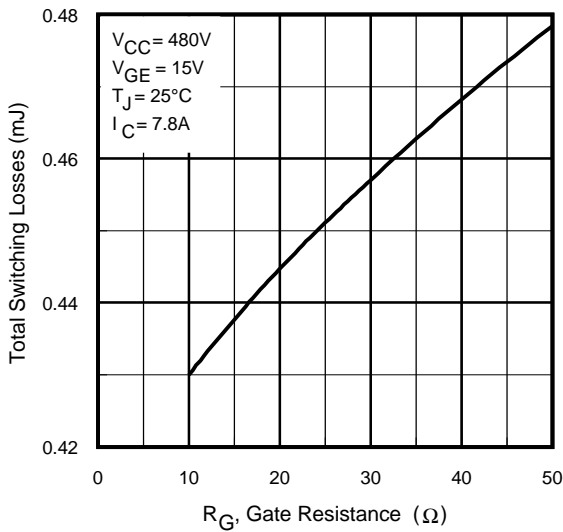
**Fig. 6** - Maximum Effective Transient Thermal Impedance, Junction-to-Case



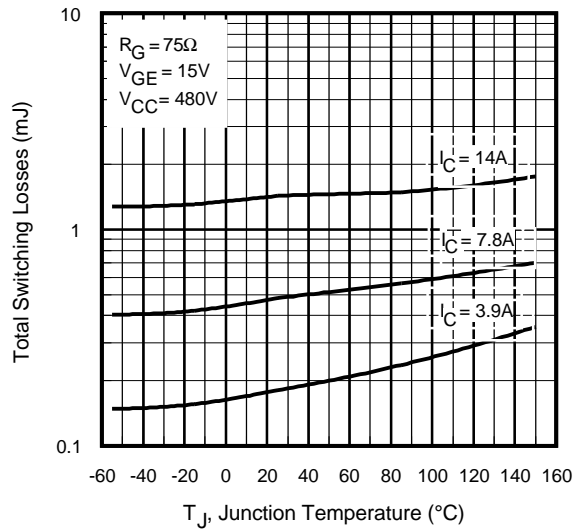
**Fig. 7** - Typical Capacitance vs. Collector-to-Emitter Voltage



**Fig. 8** - Typical Gate Charge vs. Gate-to-Emitter Voltage



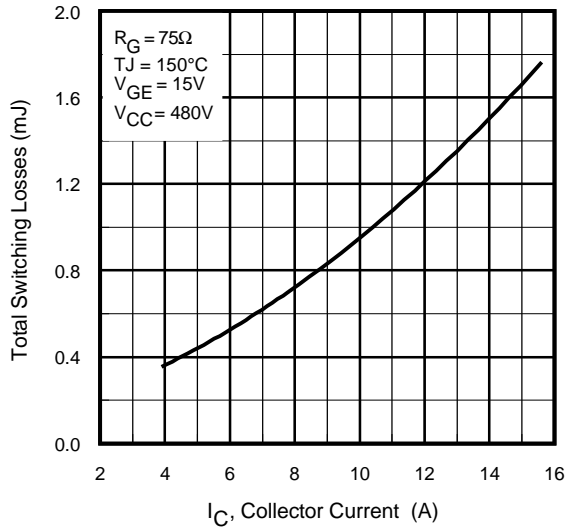
**Fig. 9** - Typical Switching Losses vs. Gate Resistance



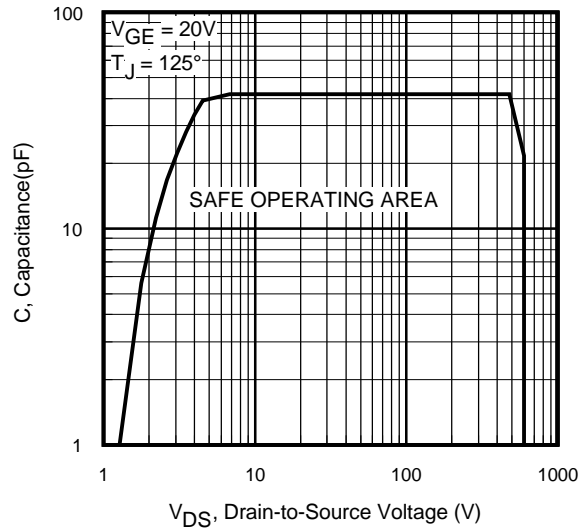
**Fig. 10** - Typical Switching Losses vs. Junction Temperature

# IRG4BC15UD

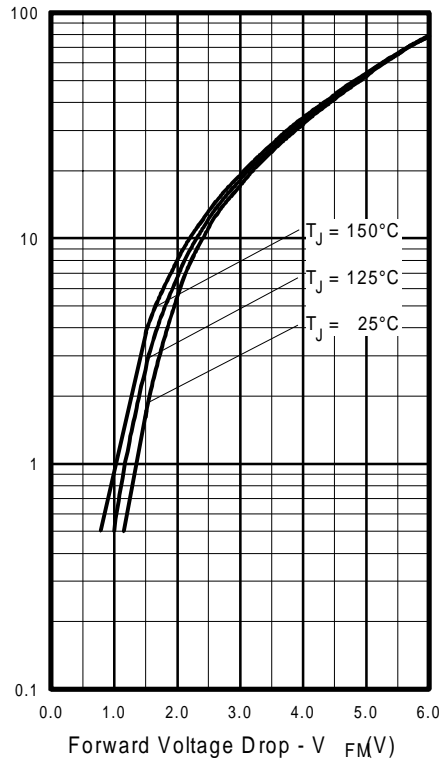
International  
**IR** Rectifier



**Fig. 11** - Typical Switching Losses vs. Collector-to-Emitter Current



**Fig. 12** - Turn-Off SOA



**Fig. 13** - Maximum Forward Voltage Drop vs. Instantaneous Forward Current

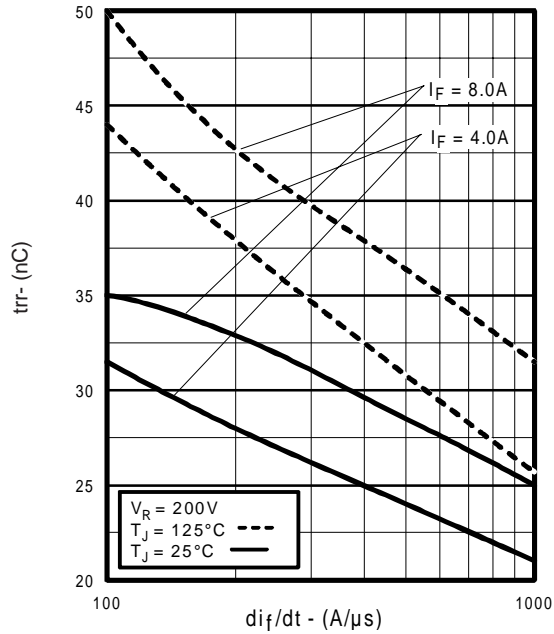


Fig. 14 - Typical Reverse Recovery vs.  $di_f/dt$

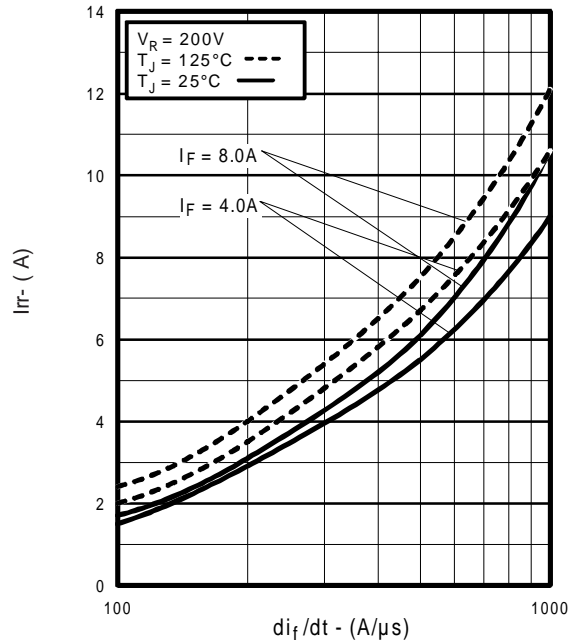


Fig. 15 - Typical Recovery Current vs.  $di_f/dt$

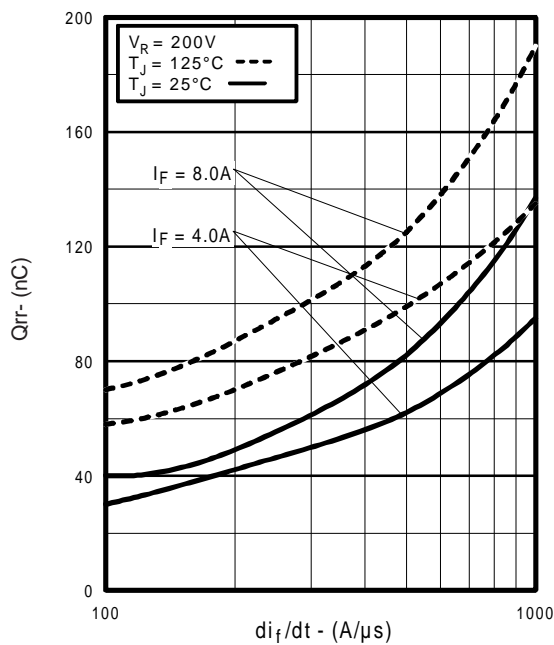


Fig. 16 - Typical Stored Charge vs.  $di_f/dt$

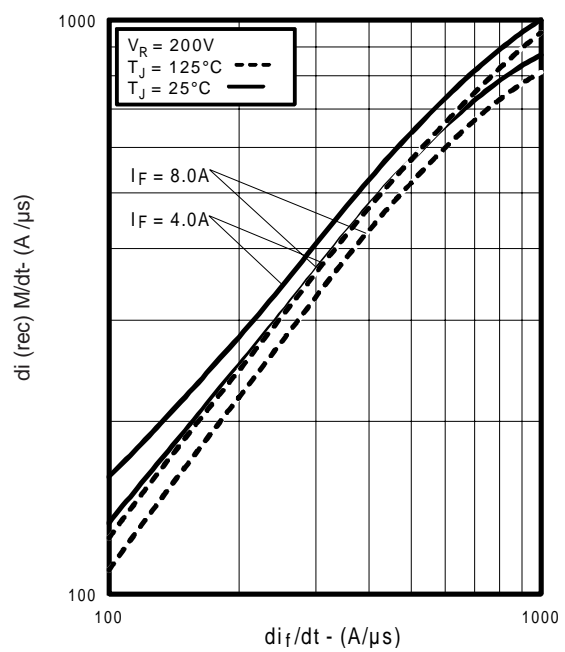
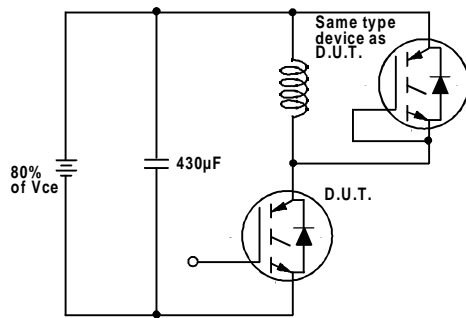


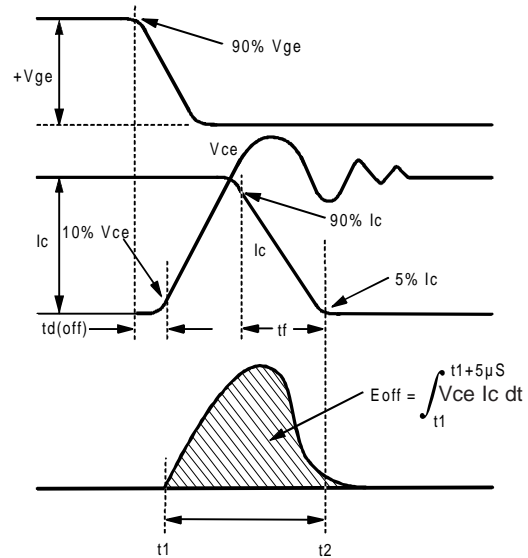
Fig. 17 - Typical  $di_{(rec)M}/dt$  vs.  $di_f/dt$ ,

# IRG4BC15UD

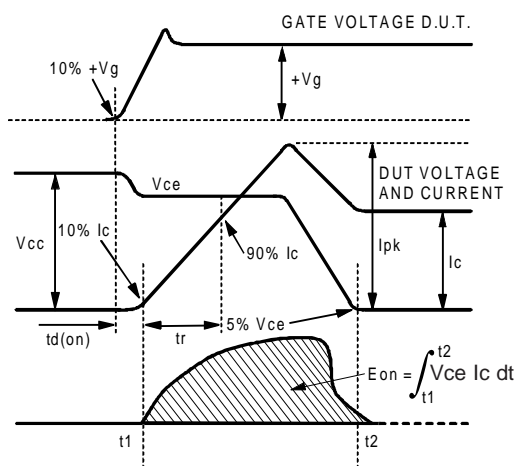
International  
**IR** Rectifier



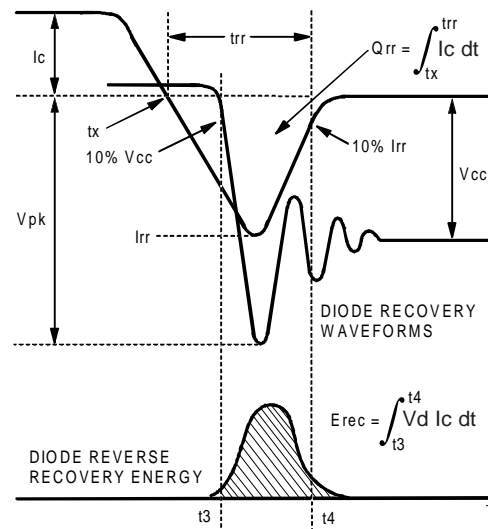
**Fig. 18a** - Test Circuit for Measurement of  $I_{LM}$ ,  $E_{on}$ ,  $E_{off}(\text{diode})$ ,  $t_{rr}$ ,  $Q_{rr}$ ,  $I_{rr}$ ,  $t_{d(on)}$ ,  $t_r$ ,  $t_{d(off)}$ ,  $t_f$



**Fig. 18b** - Test Waveforms for Circuit of Fig. 18a, Defining  $E_{off}$ ,  $t_{d(off)}$ ,  $t_f$



**Fig. 18c** - Test Waveforms for Circuit of Fig. 18a, Defining  $E_{on}$ ,  $t_{d(on)}$ ,  $t_r$



**Fig. 18d** - Test Waveforms for Circuit of Fig. 18a, Defining  $E_{rec}$ ,  $t_{tr}$ ,  $Q_{rr}$ ,  $I_{rr}$



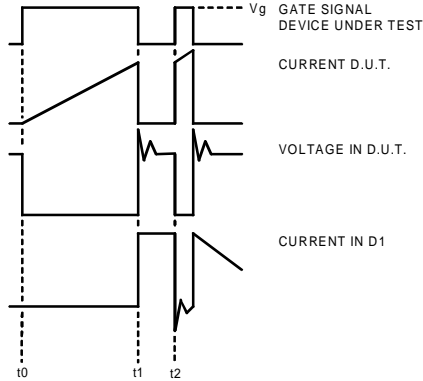


Figure 18e. Macro Waveforms for Figure 18a's Test Circuit

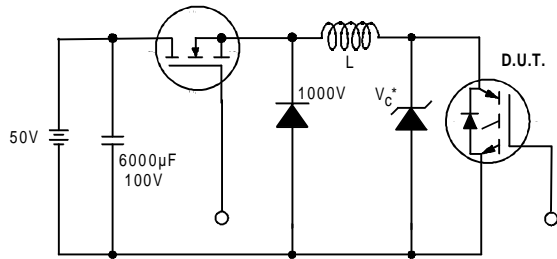


Figure 19. Clamped Inductive Load Test Circuit

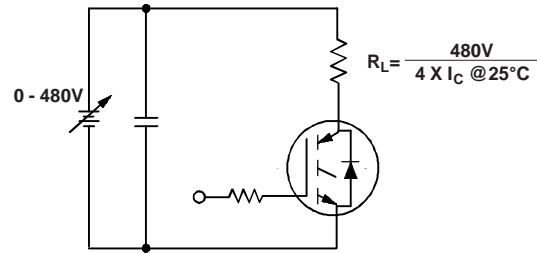


Figure 20. Pulsed Collector Current Test Circuit

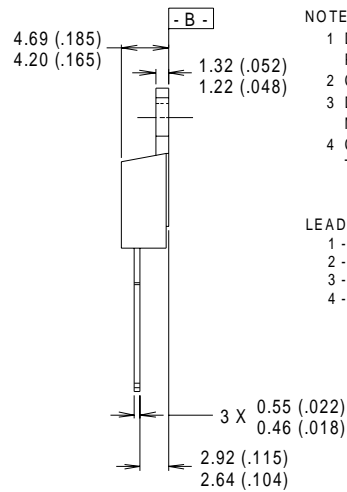
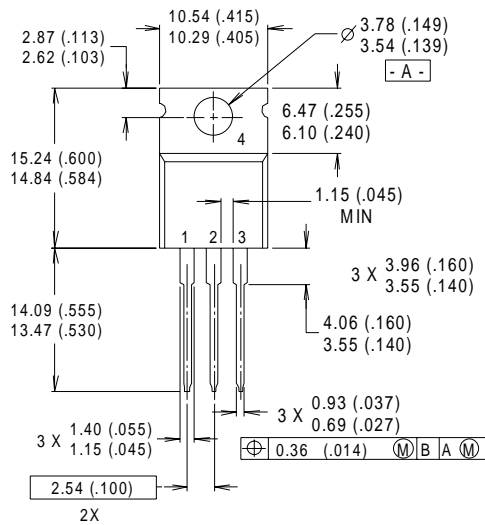
# IRG4BC15UD

International  
**IR** Rectifier

## Notes:

- ① Repetitive rating:  $V_{GE}=20V$ ; pulse width limited by maximum junction temperature
- ②  $V_{CC}=80\%(V_{CES})$ ,  $V_{GE}=20V$ ,  $L=10\mu H$ ,  $R_G = 75\Omega$
- ③ Pulse width  $\leq 80\mu s$ ; duty factor  $\leq 0.1\%$ .
- ④ Pulse width  $5.0\mu s$ , single shot.

## Case Outline — TO-220AB



- NOTES:
- 1 DIMENSIONS & TOLERANCING PER ANSI Y14.5M, 1982.
  - 2 CONTROLLING DIMENSION : INCH.
  - 3 DIMENSIONS ARE SHOWN MILLIMETERS (INCHES).
  - 4 CONFORMS TO JEDEC OUTLINE TO-220AB.

### LEAD ASSIGNMENTS

- 1 - GATE
- 2 - COLLECTOR
- 3 - EMITTER
- 4 - COLLECTOR

**CONFORMS TO JEDEC OUTLINE TO-220AB**

Dimensions in Millimeters and (Inches)

Data and specifications subject to change without notice.  
This product has been designed and qualified for the industrial market.  
Qualification Standards can be found on IR's Web site.

International  
**IR** Rectifier

**IR WORLD HEADQUARTERS:** 233 Kansas St., El Segundo, California 90245, USA Tel: (310) 252-7105  
TAC Fax: (310) 252-7903

Visit us at [www.irf.com](http://www.irf.com) for sales contact information.03/01