

## SINGLE NUMBER PULSE TONE SWITCHABLE DIALER

- SINGLE CHIP DTMF AND PULSE DIALER
- SOFTSWITCH CHANGES SIGNALING MODE FROM PULSE TO TONE
- RECALL OF LAST NUMBER DIALED (up to 28 digits long)
- FLASH KEY INPUT INITIATES TIMED HOOK FLASH
- TIMED PABX PAUSE
- 8 TONES PER SECOND DIALING IN TONE MODE AND 10 PPS IN PULSE MODE
- DTMF ACTIVE UNTIL KEY RELEASE
- MINIMUM DTMF DURATION/SEPARATION GUARANTEED (74/54ms)
- PACIFIER TONE PROVIDES AUDIBLE INDICATION OF VALID KEY INPUT FOR NON-DTMF KEY ENTRIES
- POWERED FROM TELEPHONE LINE, LOW OPERATING VOLTAGE FOR LONG LOOP APPLICATIONS

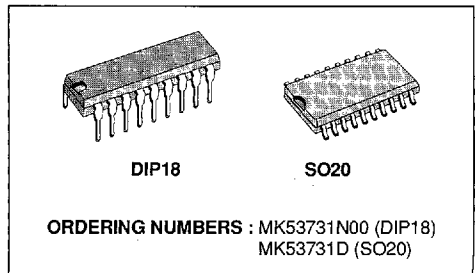

### DESCRIPTION

The MK53731 is a Silicon Gate CMOS IC that provides necessary signals for either DTMF or loop disconnect (pulse) dialling. The MK53731 buffers up to 28 digits into memory that can be later redialed with a single key input. This memory capacity is sufficient for local, long distance, overseas, and even computerized long-haul networks. Users can store all 12 signalling keys and access several unique functions with single key entries. These functions include : Last Number Dialed (LND), Softswitch, Flash and Pause. Figure 2 shows the keypad configuration. A LND key input automatically redials the last number dialed.

Two features simplify PABX dialling. The PAUSE key stores a timed pause in the number sequence. Redial is then delayed until a outside line can be accessed or some other activity occurs before normal signalling resumes. The FLASH key simulates a 560ms hook flash to transfer calls or to activate other special features provided by the PABX or a central office.

**Figure 2 :** Keypad Configuration.

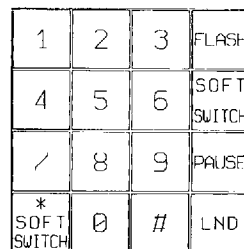

*188/MK53731-81*

**Figure 1 :** Pin Connections (top view).

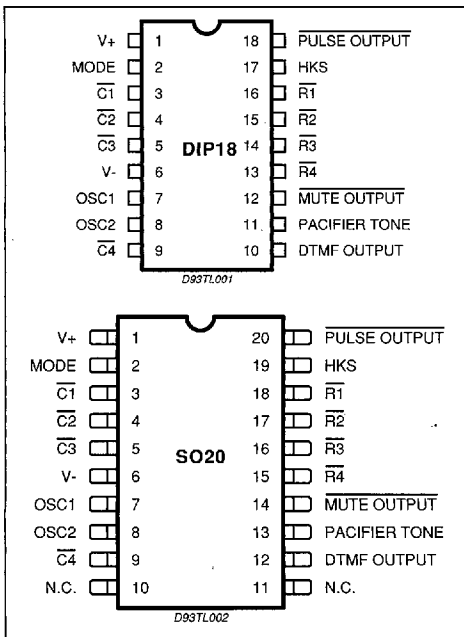

## FUNCTIONAL PIN DESCRIPTION (DIP18 only)

### V+

Pin 1. V+ is the positive supply for the circuit and must meet the maximum and minimum voltage requirements. (see Electrical Specifications).

### MODE

Input. Pin 2. MODE determines the dialer's default operating mode. When the device is powered up or the hookswitch input is switched from on-hook, (V+), to off-hook, (V-), the default determines the signaling mode. A V+ connection defaults to tone mode operation and a V- connection defaults to pulse mode operation.

When dialling in the pulse mode, a softswitch feature will allow a change to the tone mode whenever the \* key, or softswitch, is depressed. Subsequent \* key inputs will cause the DTMF code for an \* to be dialed. The softswitch will only switch from pulse to tone. After returning to on-hook and back to off-hook, the part will be in pulse mode. Redial by the LND key will repeat the softswitch.

### $\overline{C1}$ , $\overline{C2}$ , $\overline{C3}$ , $\overline{C4}$ , $\overline{R4}$ , $\overline{R3}$ , $\overline{R2}$ , $\overline{R1}$

Keyboard inputs. The MK53731 interfaces with either the standard 2-of-8 with negative common or the single-contact (Form A) keyboard.

A valid keypad entry is either a single Row connected to a single Column or V- simultaneously presented to both a single Row or Column. In its quiescent or standby state, during normal off-hook operation, either the Rows or the Columns are at a logic level 1 (V+). Pulling one input low enables the on-chip oscillator. Keyboard scanning then begins. Scanning consists of Rows and Columns alternately switching high through on-chip pullups. After both a Row and Column key have been detected, the debounce counter is enabled and any noise (bouncing contacts, etc.) is ignored for a debounce period ( $T_{KD}$ ) of 32 ms. At this time, the keyboard is sampled and if both Row and Column information are valid, the information is buffered into the LND location. If switched on-hook (pin 17 to pin 1), the keyboard inputs are pull high through on-chip pull-up resistors.

In the tone mode, if 2 or more keys in the same row or if 2 or more keys in the same column are depressed a single tone will be output. The tone will correspond to the row or column for which the 2 keys were pushed. This feature is for test purposes, and single tones will not be redialed.

Also in the tone mode, the output tone is continuous in manual dialing as long as the key is pushed. The output tone duration follows the table 1.

**Table 1.** Output Tone Duration.

Key – Push Time, T*	Tone Output *
$T \leq 32\text{ms}$	No Output, Ignored by MK53731.
$32\text{ms} \leq T \leq 75\text{ms} + T_{DK}$	75ms Duration Output
$T \geq 75\text{ms} + T_{KD}$	Output Duration = $T - T_{KD}$

\* **Note :**  $T_{KD}$  is the keypad debounce time which is typically 32 ms.

When redialing in the tone mode, each DTMF output is 75 ms duration, and the tone separation (intersignal delay) is 50 ms.

### V-

Pin 6 is the negative supply input to the device. This is the voltage reference for all specifications.

### OSC1, OSC2

Pin 7 (input), pin 8 (output). OSC1 and OSC2 are connections to an on-chip inverter used as the timing reference for the circuit. It has sufficient loop gain to oscillate when used with a low-cost television color-burst crystal. The nominal crystal frequency is 3.579545 MHz and any deviation from this standard is directly reflected in the Tone output frequencies. The crystal oscillator provides the time reference for all circuit functions. A ceramic resonator with tolerance of  $\pm 0.25\%$  may also be used.

### DTMF OUTPUT

Output. Pin 10. An NPN transistor emitter with a collector tied to V+ drives the DTMF OUTPUT pin. The transistor base is connected to an on-chip operational amplifier that mixes the Row and Column tones. Figure 7 shows the timing at this pin.

The DTMF OUTPUT is the summation of a single Row frequency and a single Column frequency. A typical single tone sine wave is shown in Figure 4. This waveform is synthesized using a resistor tree with sinusoidally weighted taps.

The MK53731 is designed to operate from an unregulated supply ; the TONE LEVEL is supply independent, and the single row tone output level will be typically :

$$T_{01} = -12 \text{ dBm} \pm 1 \text{ dB}$$

The DC component of the DTMF output while active is described by the following equation :

$$V_{DC1} = 0.3 \times V_+ + 0.5V$$

Figure 3 : MK53731 Block Diagram.

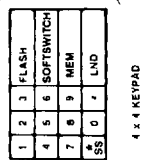
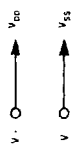
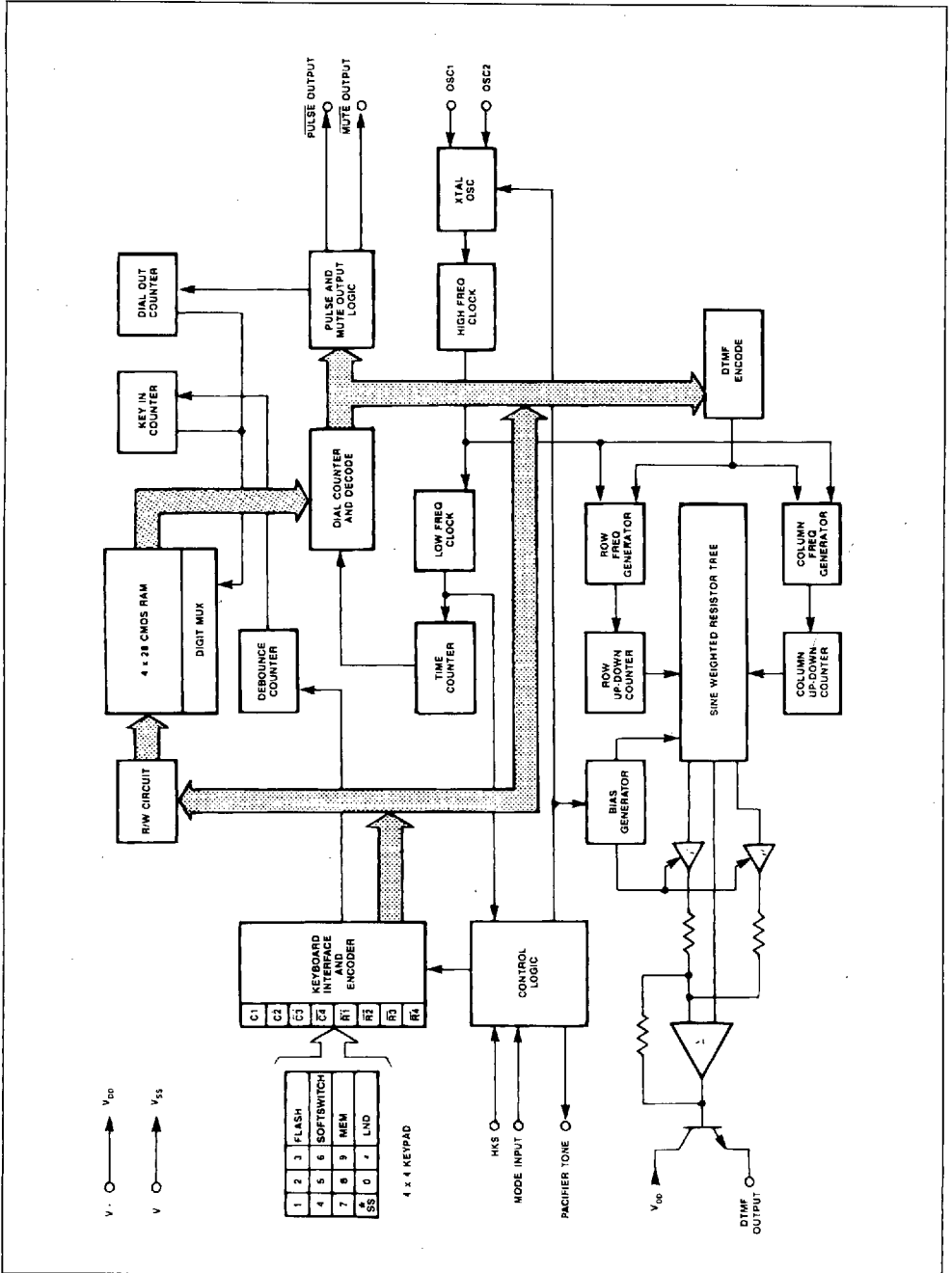

Figure 4 : Typical Single Tone.

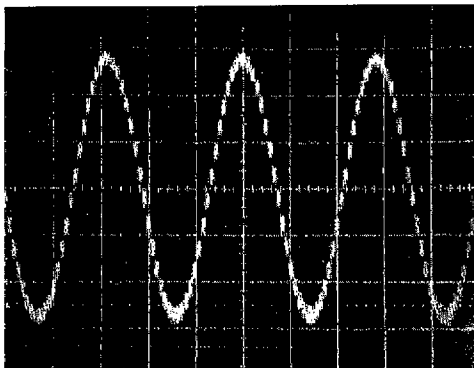

Figure 5 : Typical Dual Tone.

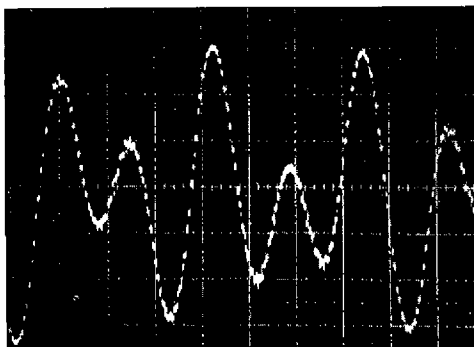
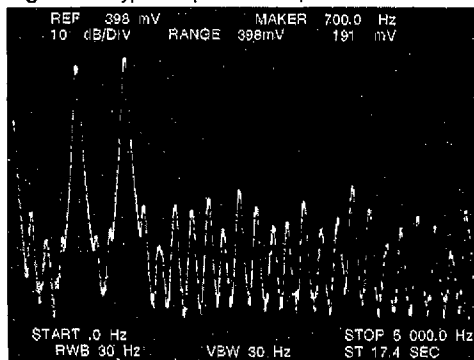

Figure 6 : Typical Spectral Response.



#### PACIFIER TONE

Output. Pin 11. A 500Hz square wave is activated upon acceptance of a valid key input, after the 32 ms debounce time. The square wave terminates after a maximum of 30 ms or when the valid key is no longer present. In pulse mode, all valid key entries activate the pacifier tone. In tone mode, any non-DTMF (FLASH, PAUSE, LND, SOFTSWITCH) entry activates the pacifier tone. The pacifier tone provides audible feedback, confirming that the key has been properly entered and accepted.

#### MUTE OUTPUT

Output. Pin 12. This pin is the MUTE OUTPUT for both tone and pulse modes. Timing is dependent upon mode.

The MUTE OUTPUT consists of an open drain N-channel device. During standby, the output is high impedance and generally has an external pullup resistor to the positive supply.

In the tone mode, MUTE OUTPUT is used to remove the transmitter and the receiver from the network during DTMF signaling. During dialing, MUTE OUTPUT is active continuously until dialing is completed. MUTE OUTPUT goes active when any key is pushed.

In the pulse mode, MUTE OUTPUT is used to remove the receiver and the network from the line. Different circuitry is required for tone and pulse muting external to the IC and applications using both modes would not necessarily share circuitry. MUTE OUTPUT timing is shown in Figure 8 for pulse mode signaling and Figure 7 for tone mode signaling. MUTE OUTPUT is active during each digit, and not active during the interdigit time. In both tone and pulse modes, MUTE OUTPUT goes active 40 ms before PULSE OUTPUT for a FLASH.

#### HKS

Input. Pin 17. Pin 17 is the hookswitch input to the MK53731. This is a high-impedance input and must be switched high for on-hook operation or low for off-hook operation. A transition on this input causes the on-chip logic to initialize, terminating any operation in progress at the time. The signaling mode defaults to the mode selected at pin 2. Figure 8 illustrates the timing for this pin.

#### PULSE OUTPUT

Output. Pin 18. This is an output consisting of an open drain N-channel device. In either pulse or tone mode, the FLASH key will cause a 560 ms output pulse at pin 18.

**DEVICE OPERATION (Tone Mode)**

When the MK53731 is not actively dialing, it consumes very little current. While on-hook, all keypad input pins are internally pulled high. Row and Column inputs assume opposite states off-hook. The circuit verifies that a valid key has been entered by alternately scanning the Row and Column inputs. If the input is still valid following 32 ms of debounce, the digit is stored into memory, and dialing begins after a pre-signal delay of approximately 40 ms

(measured from initial key closure). Output tone duration is shown in Table 2.

The MK5371 allows manual dialing of an indefinite number of digits, but if more than 28 digits are dialed, the 53731 will "wrap around". That is, the extra digits beyond 28 will be stored at the beginning of the LND buffer, and the first 28 digits will no longer be available for redial.

**Table 2 : DTMF Output Frequency.**

Key Input	Standard Frequency	Actual Frequency	% Deviation
ROW 1	697	699.1	+0.31
2	770	766.2	-0.49
3	852	847.4	-0.54
4	941	948.0	+0.74
COL 1	1209	1215.9	+0.57
2	1336	1331.7	-0.32
3	1477	1471.9	-0.35

**Figure 7 : Tone Mode Timing.**

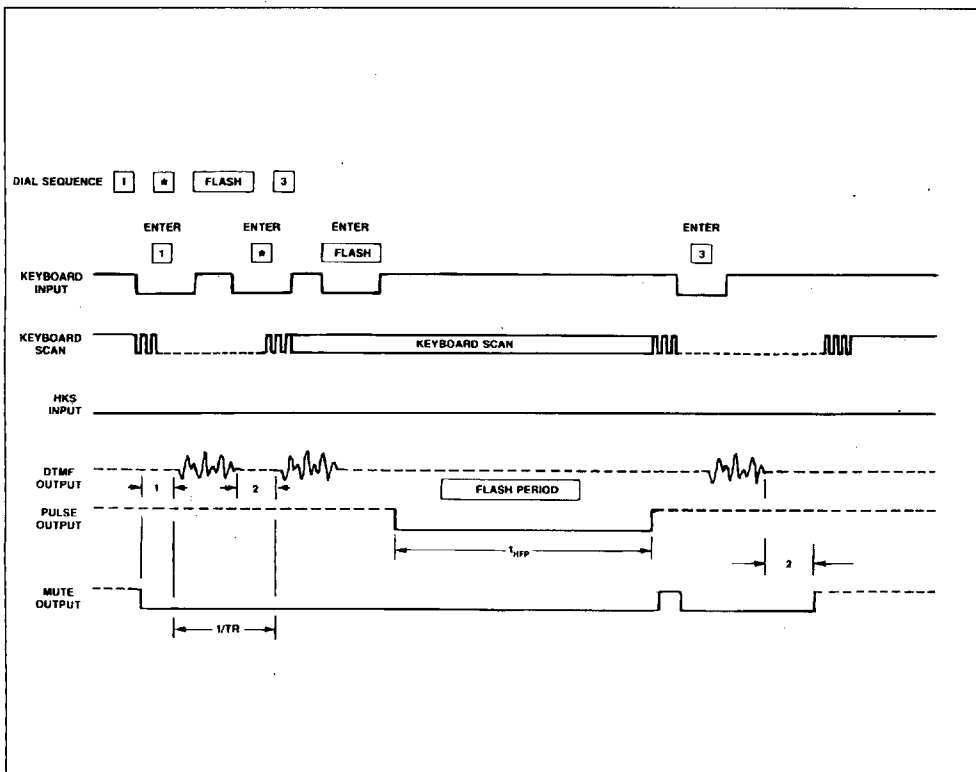

**Note :** For this example, key entries are  $\leq 75$  ms, but  $\geq 32$  ms.

Figure 8 : Pulse Mode Timing.

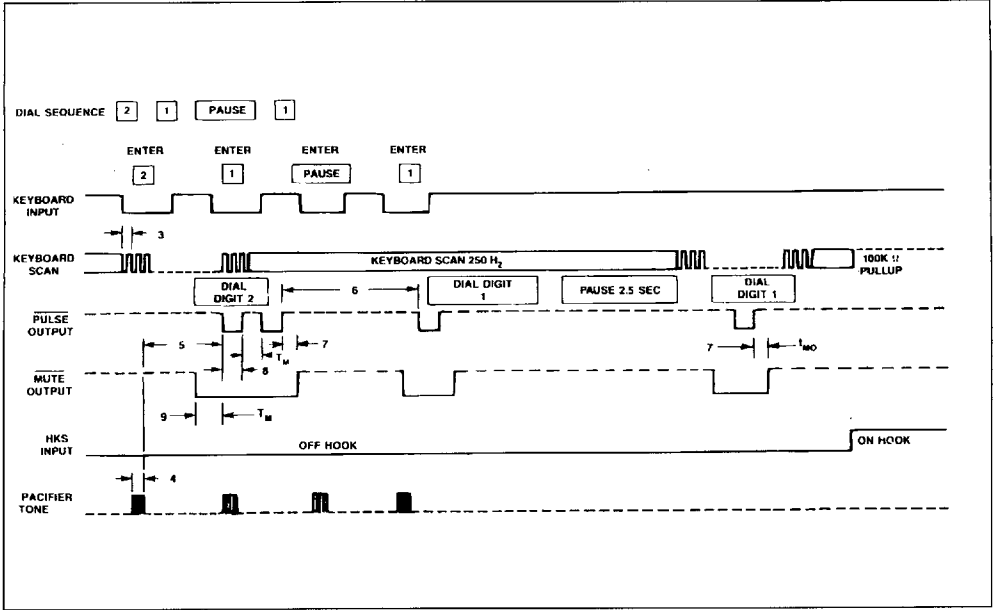

**NORMAL DIALING (off-hook)**

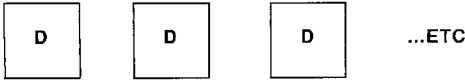

Normal dialing is straightforward, all keyboard entries will be stored in the buffer and signaled in succession.

**LAST NUMBER DIALED (LND)**



Last number dialing is accomplished by entering the LND key.

**PAUSE**



A pause may be entered into the dialed sequence at any point by keying in the special function key, PAUSE. Pause inserts a 1.1-second delay into the dialing sequence. The total delay, including pre-digital and post-digital pauses is shown in Table 3.

**HOOK FLASH**

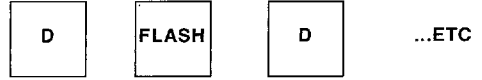

Hook flash may be entered into the dialed sequence at any point by keying in the function key, FLASH. Flash consists of a timed Break of 560 ms. The FLASH function is stored in memory, but it will not be redialed as such. When a FLASH key is pressed, no further key inputs will be accepted until the hook-flash function (560 ms break) has been dialed. The key input following a FLASH will be stored as the initial digit of a new number (overwriting the number dialed prior to the FLASH) unless it is another FLASH. Consecutive FLASH entries after a number is dialed will be stored sequentially in the LND memory and a subsequent LND entry will cause the redial of that number with a delay, but not hookflash breaks, at the end of the redialing sequence. When redialing in tone mode, MUTE OUTPUT will remain active during the flash delay period.

**SOFTSWITCH**

When the dialing in the pulse mode, a softswitch feature will allow a change to the tone mode whenever

the \* key, or SOFTSWITCH, is depressed. Subsequent \* key inputs will cause the DTMF code for an \* to be dialed. The softswitch will only switch from

pulse to tone. After returning to on-hook and back to off-hook, the part will be in pulse mode. Redial by the LND key will repeat the softswitch.

**Table 3 : Special Function Delays.**

Each delay shown below represents the time required from after the special function key is depressed until a new digit can be dialed.

The time is considered "FIRST" key if all previous inputs have been completed dialed. The time is considered "AUTO" if in redial, or if previous dialing is still in progress.

Function	First/Auto	Delay (seconds)	
		Pulse	Tone
SOFTSWITCH	FIRST	1.15	
	AUTO	1.85	
PAUSE	FIRST	1.84	1.15
	AUTO	2.50	1.20

### ABSOLUTE MAXIMUM RATINGS

Parameter	Value	Unit
DC Supply Voltage	6.5	V
Operating Temperature	-20 to +60	°C
Storage Temperature	-55 to +125	°C
Maximum Power Dissipation @ 25°C	500	mW
Maximum Voltage on any Pin	(V+) +0.3, (V-) -0.3	V

\* All specifications are for 2.5 Volt operation and full operating temperature range unless otherwise stated.

### ELECTRICAL CHARACTERISTICS (T<sub>amb</sub> = 25°C unless otherwise specified)

#### DC Characteristics

N°	Symbol	Parameter	Min.	Typ.	Max.	Unit	Notes
	V+ TONE	DC Operating Voltage	2.5		6.0	V	
	V <sub>MR</sub>	Memory Retention Voltage	1.5			V	1,6
	I <sub>S</sub>	Stand-by Current		0.4	1.0	µA	1
	I <sub>MR</sub>	Memory Retention Current		0.15	0.75	µA	5,6
	V <sub>MUTE</sub>	Mute Output Operating Voltage	1.8			V	7
	I <sub>T</sub>	Operating Current (Tone)		300	600	µA	2
	I <sub>P</sub>	Operating Current (Pulse)		150	250	µA	2
	I <sub>ML</sub>	Mute Output @ (2.5V)	1			mA	3
		Sink Current @ (4V)	3			mA	
	I <sub>PL</sub>	Pulse Output Sink Current	1	2		mA	3
	I <sub>PC</sub>	Pacifier Tone Sink/Source	250	500		µA	4
	K <sub>RU</sub>	Keypad Pullup Resistance		100		KΩ	
	K <sub>RD</sub>	Keypad Pulldown Resistance		500		Ω	
	V <sub>IL</sub>	Keypad input Level - low	0		0.3V+	V	
	V <sub>IH</sub>	Keypad Input Level - high	0.7V+		V+	V	
	V <sub>PULSE</sub>	Operating Voltage (pulse mode)	1.8		6.0	V	

- Notes :**
1. All inputs unloaded. Quiescent Mode (Oscillator off).
  2. All outputs unloaded. Single key input.
  3. V<sub>OUT</sub> = 0.4 Volts.
  4. Sink Current for V<sub>OUT</sub> = -0.5 Volts. Source Current for V<sub>OUT</sub> = 2.0 Volts.
  5. Memory Retention Voltage is the point where memory is guaranteed but circuit operation is not.
  6. Proper memory retention is guaranteed if either the minimum I<sub>MR</sub> is provided or the minimum V<sub>MR</sub>. The design does not have to provide both the minimum current or voltage simultaneously.
  7. Minimum voltage where activation of mute output with key entry is ensured.

## AC Characteristics – TONE MODE

N°	Symbol	Parameter	Min.	Typ.	Max.	Unit	Notes
	T <sub>NK</sub>	Tone Output No Key Down			80	dBm	1
	T <sub>OI</sub>	Tone Output (voltage independent)	13 173	12 194	11 218	dBm mVrms	1,2 3
	P <sub>EI</sub>	Pre-emphasis, High Band	1.4	2	2.6	dB	
	DC <sub>i</sub>	Tone Output DC Bias (V+ = -2.5V) (V+ = 3.5V)		1.25 1.5		V V	
	R <sub>E</sub>	Tone Output load		10		KΩ	4
	T <sub>RIS</sub>	Tone Output Rise Time		1		ms	5
	DIS	Output DTMF Distortion		5	8	%	3
	TR	Tone Signalling Rate		5		1/sec	
1	T <sub>PSD</sub>	Pre-signal Delay	40			ms	6
2	T <sub>ISD</sub>	Inter-signal Delay (repertory)		54		ms	
	T <sub>DUR</sub>	Tone Output Duration (repertory)		74		ms	

- Notes :**
- 0 dBm equals 1 mW power into 600 Ω or 775 mVolts Important Note. The MK53731 is designed to drive a 10 kΩ load. The 600 Ω load is only for reference.
  - Single tone (low group) as measured at pin 10 T<sub>A</sub> = 25 °C.
  - Supply voltage = 2.5V; R<sub>E</sub> = 10 kΩ. T<sub>OI</sub> increases typically of 10mVrms with V<sub>supply</sub> = 6.0V.
  - Supply voltage = 2.5 Volts.
  - Time from beginning of tone output waveform to 90% of final magnitude of either frequency Crystal parameters suggested for proper operation are R<sub>S</sub> < 100 Ω, L<sub>m</sub> = 96 mH, C<sub>m</sub> 0.02 pF, C<sub>i1</sub> = 5pF, f = 3.579545 MHz and C<sub>L</sub> = 18 pF.
  - Time from initial key input until beginning of signaling.

AC Characteristics – KEYPAD INPUTS, PACIFIER TONE  
(numbers in left hand column refer to the limiting diagrams)

N°	Symbol	Parameter	Min.	Typ.	Max.	Unit	Notes
3	T <sub>KD</sub>	Keypad Debounce Time		32		ms	1
	F <sub>KS</sub>	Keypad Scan Frequency		250		Hz	1
	F <sub>PT</sub>	Frequency Pacifier Tone		500		Hz	1
4	T <sub>PT</sub>	Pacifier Tone Duration		30		ms	1
	THFP	Hookflash Timing		560		ms	1

- Note :** 1. Crystal oscillator accuracy directly affects these times.

## AC Characteristics – PULSE MODE OPERATION

N°	Symbol	Parameter	Min.	Typ.	Max.	Unit	Notes
	P <sub>R</sub>	Pulse Rate		10		PPS	1
5	P <sub>Dp</sub>	Pedigital Pause		48		ms	2
6	I <sub>Dp</sub>	Intrdigital Pause		740		ms	2
7	T <sub>MO</sub>	Mute Overlap Time		2		ms	2
8	T <sub>B</sub>	Break Time		60		ms	2
9	T <sub>M</sub>	Make Time		40		ms	2

- Notes :**
- 10 PPS is the nominal rate.
  - Figure 8 illustrates this relationship.