



5mm Phototransistor,T-1 3/4

MODEL NO : PT334-6B

■ Features :

- Fast response time
- High photo sensitivity

■ Description :

PT334-6B is a high speed and high sensitive silicon NPN epitaxial planar phototransistor in a standard $\phi 5$ mm package. The package is an IR filter, spectrally match to infrared emitter diode .

■ Applications :

- Optoelectronic switch
- VCRs ,Video camera
- Floppy disk drive
- Infrared applied system

PART NO.	CHIP	LENS COLOR
	MATERIAL	
PT	Silicon	Black



5mm Phototransistor, T-1 3/4

MODEL NO : PT334-6B

■ Package Dimensions :

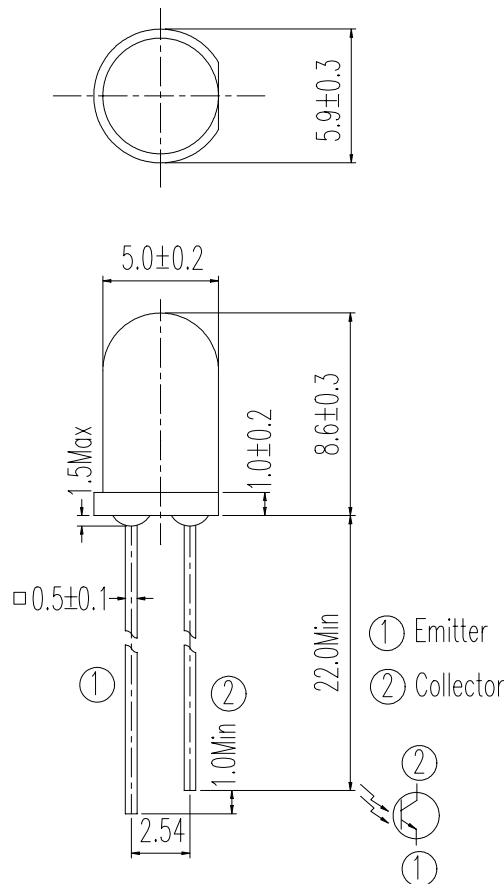

■ Notes :

1. All dimensions are in millimeter.
2. Protruded resin under flange 1.5 mm Max.
3. Lead spacing is measured where the lead emerge from the package.
4. Lens color : Black.
5. Above specification may be changed without notice. EVERLIGHT will reserve authority on material change for above specification.
6. These specification sheets include materials protected under copyright of EVERLIGHT corporation . Please don't reproduce or cause anyone to reproduce them without EVERLIGHT's consent.
7. When using this product , please observe the absolute maximum ratings and the instructions for use outlined in these specification sheets. EVERLIGHT assumes no responsibility for any damage resulting from use of the product which does not comply with the absolute maximum ratings and the instructions included in these specification sheets.



5mm Phototransistor, T-1 3/4

MODEL NO : PT334-6B

■ Absolute Maximum Ratings at T_A = 25°C

Parameter	Symbol	Rating	Unit	Notice
Collector-Emitter Voltage	V _{CEO}	30	V	
Emitter-Collector- Voltage	V _{ECO}	5	V	
Collector Current	I _C	20	mA	
Operating Temperature	Topr	-25 ~ +85	°C	
Storage Temperature	Tstg	-40 ~ +85	°C	
Soldering Temperature	Tsol	260	°C	4mm from mold body less than 5 seconds
Power Dissipation at(or below) 25°C Free Air Temperature	Pc	75	mW	

■ Electronic Optical Characteristics :

Parameter	Symbol	Min.	Typ.	Max.	Unit	Condition
Collector-Emitter Breakdown Voltage	BV _{CEO}	30	----	----	V	I _C =100 μA Ee=0mW/cm ²
Emitter-Collector Breakdown Voltage	BV _{ECO}	5	----	----	V	I _E =100 μA Ee=0mW/cm ²
Collector-Emitter Saturation Voltage	V _{CE(sat)}	----	----	0.4	V	I _C =2mA Ee=1mW/cm ²
Rise Time	t _r	----	15	----	μS	V _{CE} =5V I _C =1mA R _L =1000Ω
Fall Time	t _f	----	15	----		
Collector Dark Current	I _{CEO}	----	----	100	nA	V _{CE} =20V Ee=0mW/cm ²
On State Collector Current	I _{C(on)}	0.7	2.0	----	mA	V _{CE} =5V Ee=1mW/cm ²
Wavelength of Peak Sensitivity	λ _p	----	980	----	nm	----
Rang of Spectral Bandwidth	λ _{0.5}	----	840---1200	----	nm	----



5mm Phototransistor, T-1 3/4

MODEL NO : PT334-6B

Typical Electrical/Optical/Characteristics Curves

Fig.1 Collector Power Dissipation vs. Ambient Temperature

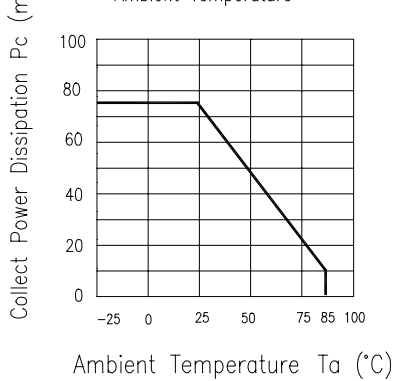

Fig.2 Collector Dark Current vs. Ambient Temperature

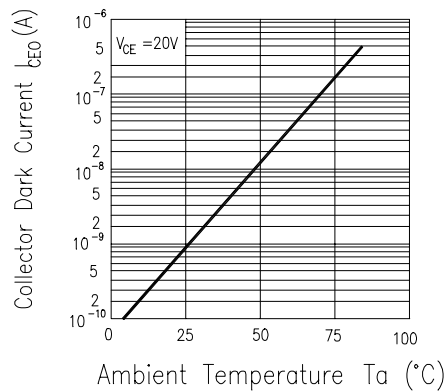

Fig. 3 Relative Collector Current vs. Ambient Temperature

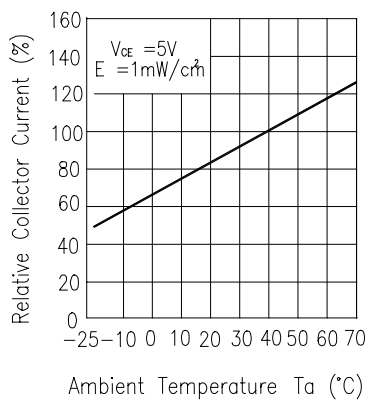

Fig.4 Collector Current vs. Irradiance

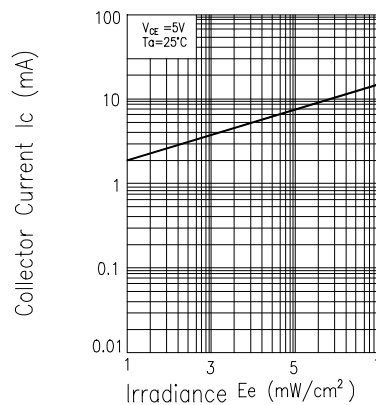

Fig.5 Spectral Sensitivity

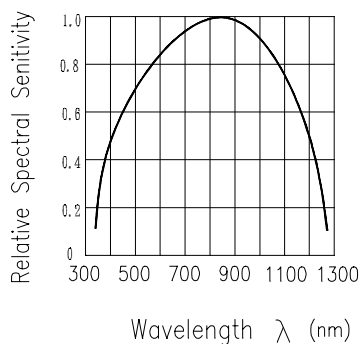
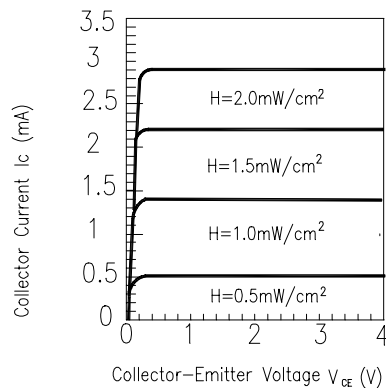

Fig.6 Collector Current vs. Collector-Emitter Voltage





EVERLIGHT ELECTRONICS CO., LTD.

DEVICE NUMBER : CDPT-033-001 REV : 1
 ECN : _____ PAGE : 5/7

5mm Phototransistor,T-1 3/4

MODEL NO : PT334-6B

■ Reliability Test Item And Condition

The reliability of products shall be satisfied with items listed below.

Confidence level:90%

LTPD:10%

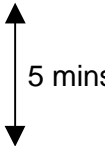
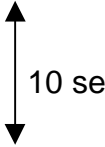
NO.	Item	Test Conditions	Test Hours/ Cycles	Sample Size	Failure Judgement Criteria	Ac/Re
1	Solder Heat	TEMP : 260°C ± 5 °C	5 secs	22 pcs	$I_{c(on)} \leq L \times 0.8$ L :Lower specification limit	0/1
2	Temperature Cycle	H : +85°C 30 mins  L : -55°C 30 mins	50 cycles	22 pcs		0/1
3	Thermal Shock	H : +100°C 5 mins  L : -10°C 5 mins	50 cycles	22 pcs		0/1
4	High Temperature Storage	TEMP. : +100°C	1000 hrs	22 pcs		0/1
5	Low Temperature Storage	TEMP. : -55°C	1000 hrs	22 pcs		0/1
6	DC Operating Life	$V_{CE}=5V$	1000 hrs	22 pcs		0/1
7	High Temperature / High Humidity	85°C / 85% R.H.	1000 hrs	22 pcs		0/1



5mm Phototransistor, T-1 3/4

MODEL NO : PT334-6B

Test Method For On State Collector Current :

Condition : $E_e=1\text{mW/cm}^2$, $V_{CE}=5\text{V}$

Test Item : Collector Current [$I_{C(on)}$]

Unit : mA

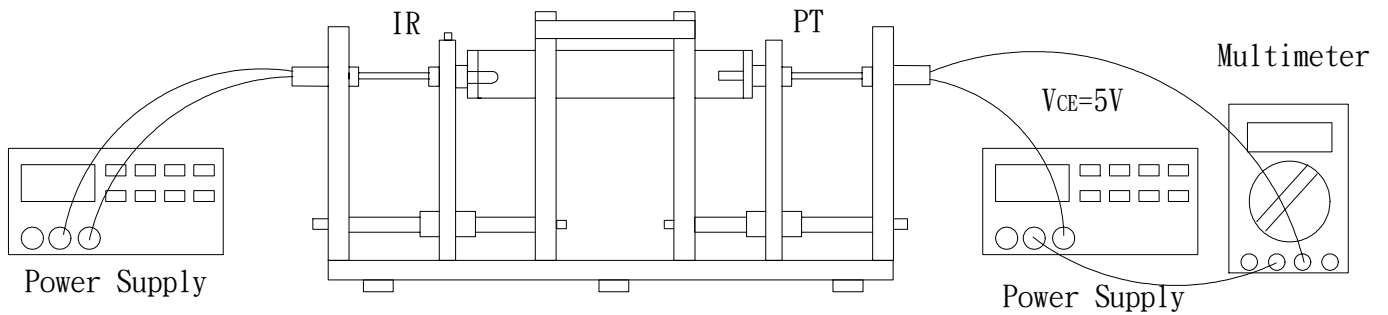



EVERLIGHT ELECTRONICS CO., LTD.

DEVICE NUMBER : CDPT-033-001 REV : 1
ECN : _____ PAGE : 7/7

5mm Phototransistor, T-1 3/4

MODEL NO : PT334-6B

■ Packing Specifications

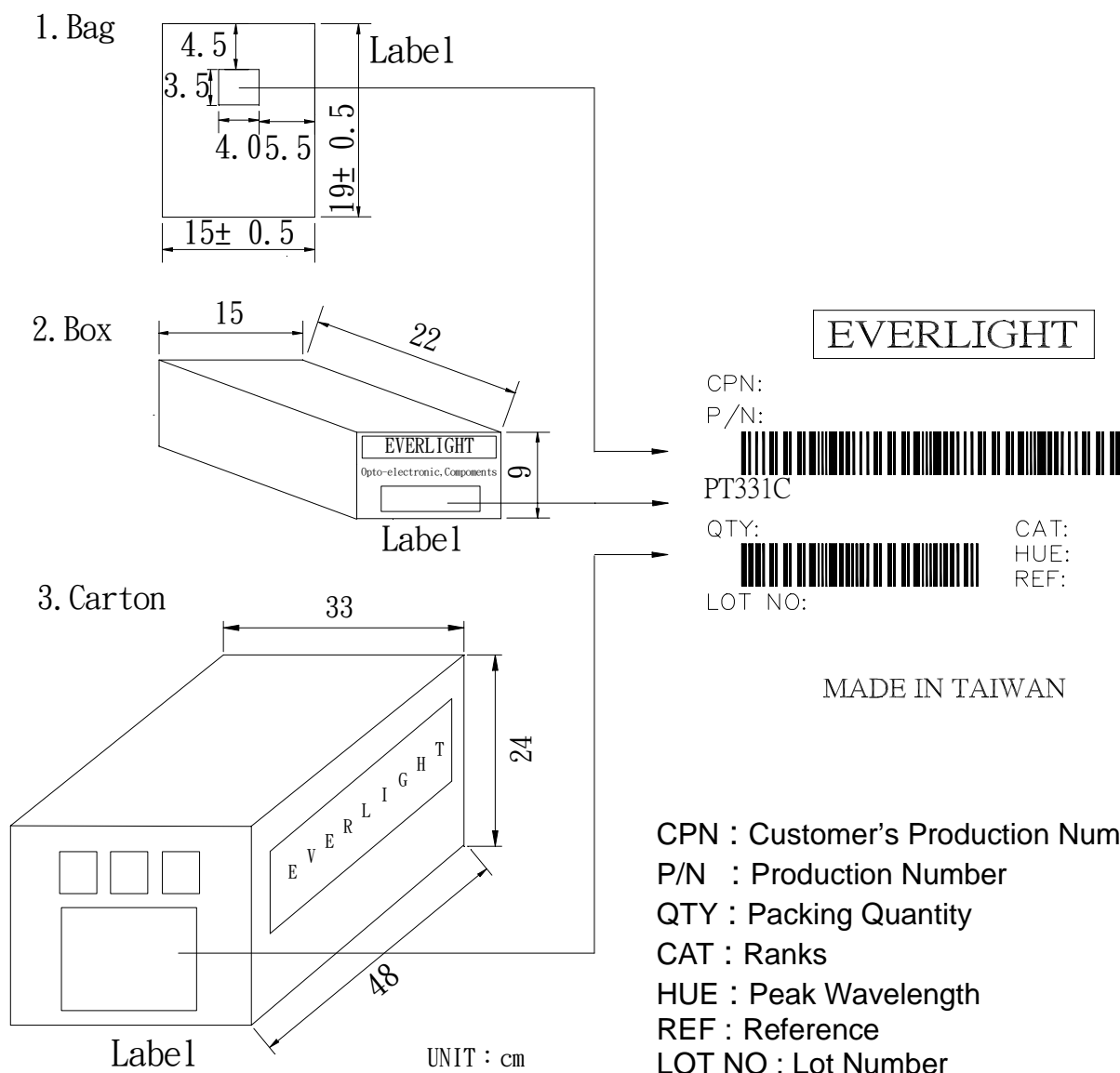

■ Packing Quantity Specification

- 500 Pcs/1Bag , 6 Bags/1Box
- 10 Boxes/1Carton