

### Applications

- IEEE 802.11b DSSS Radios, Wireless LAN
- 2.4GHz Cordless Phones, ISM Radios
- Bluetooth™ Wireless Technology

### Features

- High linear output power for IEEE802.11b, +20dBm, ACPR 1<sup>st</sup> lobe -30dBc, 2<sup>nd</sup> lobe -50dBc
- Low current consumption: 110mA at 3.3V
- High saturated output power for cordless telephone applications: +23dBm, 140mA at 3.6V
- Single supply voltage: 2.7 to 3.6V
- Wide Temperature range: -40 to +85°C
- Integrated linear analog control for DC current and output power management
- Small plastic package, 6 Pin LPCC

### Product Description

The SE2520L is a power amplifier IC designed for the 2.4GHz ISM band and compliant with the IEEE 802.11b WLAN standard, providing up to +20dBm typical output power at 3.3V with ACPR of -30dBc 1<sup>st</sup> lobe and -50dBc 2<sup>nd</sup> lobe, and requiring only 110mA.

For 2.4GHz cordless telephone applications, the SE2520L produces +23dBm typical saturated output power at 3.6V.

The SE2520L contains a linear analog control (0.1 to 1.6V) for controlling DC current and output power.

The SE2520L includes a digital enable control for device on/off control. Ramping is 1 µsec typical.

This device is capable of operating at a duty cycle of 100 percent.

### Ordering Information

Type	Package	Remark
SE2520L	6 Pin LPCC <sup>(1)</sup>	Samples
SE2520L-R	6 Pin LPCC <sup>(1)</sup>	Shipped in Tape & Reel
SE2520L-EK1	Evaluation Kit	Standard
SE2520L-EK3	Evaluation Kit	Power Detect, Filter, Rx/Tx and Diversity Switches

**Notes:** (1) JEDEC QFN package.

### Functional Block Diagram

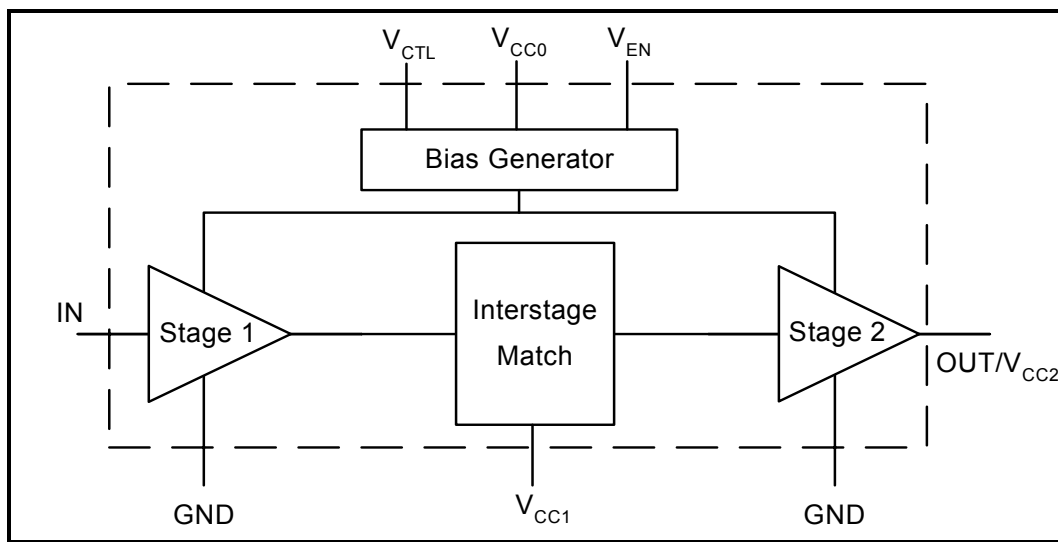

### Pin Out Diagram

Note: Pads and die pad shown are at the bottom of package.

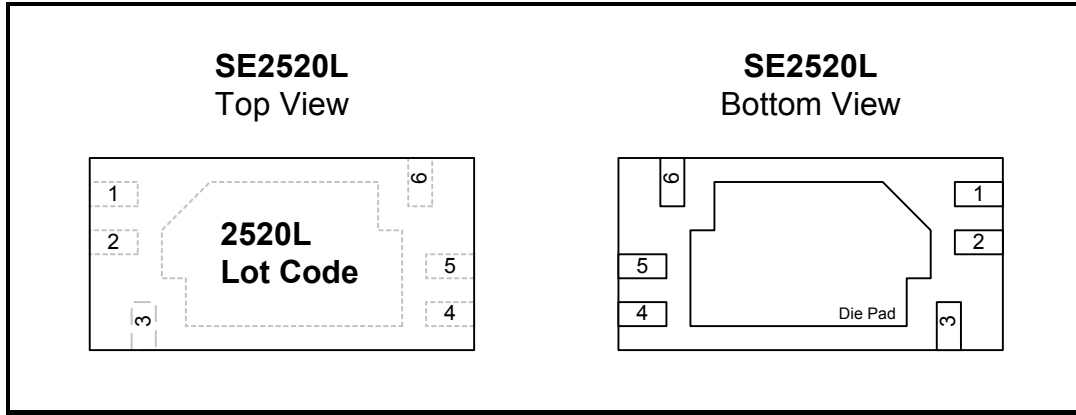

### Pin Out Description

Pin No.	Name	Description
1	V <sub>CTL</sub>	Controls the RF output power level and DC current of the power amplifier. An analog control signal between 0.1V and 1.6V varies the PA output power between Min. and Max. values.
2	V <sub>EN</sub>	Power Amplifier Enable pin. A digital control signal with logic high (power up) and logic low (power down) is used to turn the device on and off.
3	IN	Power amplifier RF input, external input matching network with DC blocking is required.
4	V <sub>CC0</sub>	Bias supply voltage.
5	V <sub>CC1</sub>	Stage 1 collector supply voltage, an external inter-stage matching network is required.
6	OUT/V <sub>CC2</sub>	PA Output and Stage2 collector supply voltage, external output matching network with DC blocking is required.
Die Pad	GND	Heatslug Die Pad is ground

### Absolute Maximum Ratings

These are stress ratings only. Exposure to stresses beyond these maximum ratings may cause permanent damage to, or affect the reliability of the device. Avoid operating the device outside the recommended operating conditions defined below. This device is ESD sensitive with an ESD rating of < 600V. Handling and assembly of this device should be at ESD protected workstations.

Symbol	Parameter	Min.	Max.	Unit
V <sub>CC</sub>	Supply Voltage (V <sub>CC0</sub> , V <sub>CC1</sub> , V <sub>CC2</sub> )	-0.3	+3.6	V
V <sub>CTL</sub>	Control Voltage	-0.3	V <sub>CC</sub>	V
V <sub>EN</sub>	Power Amplifier Enable	-0.3	V <sub>CC</sub>	V
IN	RF Input Power		+8	dBm
T <sub>STG</sub>	Storage Temperature Range	-40	+150	°C
T <sub>j</sub>	Maximum Junction Temperature		+150	°C

### Recommended Operating Conditions

Symbol	Parameter	Min.	Typ.	Max.	Unit
T <sub>A</sub>	Operating Temperature	-40		+85	°C
V <sub>CC</sub>	Supply Voltage	2.7	3.3	3.6	V

### DC Electrical Characteristics

Conditions: V<sub>CC0</sub> = V<sub>CC1</sub> = V<sub>CC2</sub> = V<sub>EN</sub> = 3.3V, V<sub>CTL</sub> = 1.6V, P<sub>IN</sub> = -8dBm, T<sub>A</sub> = 25°C, f = 2.45GHz, using SiGe SE2520L-EV1 Evaluation Board.

Symbol	Parameter	Min.	Typ.	Max.	Unit
I <sub>CC</sub>	Supply Current, V <sub>CTL</sub> = 1.6V, P <sub>IN</sub> = -8dBm		110	130	mA
I <sub>CC(sat)</sub>	Supply Current (sat) @ P <sub>IN</sub> = 2dBm		140	175	mA
ΔI <sub>CCTEMP</sub>	Supply Current variation over temperature from T <sub>A</sub> = 25°C (-40°C < T <sub>A</sub> < +85°C)		25		%
V <sub>CTL</sub>	PA Output Power Control Voltage Range	0.1		1.6	V
I <sub>CTL</sub>	Current Sunk by V <sub>CTL</sub> Pin		60	100	μA
V <sub>EN</sub>	Logic High Voltage	2.0			V
	Logic Low Voltage			0.8	V
I <sub>STBY</sub>	Leakage Current when V <sub>EN</sub> = 0V, V <sub>CTL</sub> = 0V		0.1	200	μA

### AC Electrical Characteristics

Conditions:  $V_{CC0} = V_{CC1} = V_{CC2} = V_{EN} = 3.3V$ ,  $V_{CTL} = 1.6V$ ,  $P_{IN} = -8dBm$ ,  $T_A = 25^\circ C$ ,  $f = 2.45GHz$ , using SiGe SE2520L-EV1 Evaluation Board.

Symbol	Parameter	Note	Min.	Typ.	Max.	Unit
$f_{L-U}$	Frequency Range	1	2400		2500	MHz
$P_{OUT}$	Output power, $P_{IN} = -8dBm$ , $V_{CTL} = 1.6V$	1	18	20	22	dBm
	Output power, $P_{IN} = -8dBm$ , $V_{CTL} = 0.1V$	1		-10	5	dBm
	Saturated Output Power, $P_{IN} = +2dBm$ , $V_{CTL} = 1.6V$	1	21	23		dBm
$dP_{OUT}/dV_{CTL}$	Control Voltage Sensitivity			40		dBm/V
G	Gain, small signal			29		dB
$G_{VAR}$	Gain Variation over band (2400-2485 MHz)			1.0	2.0	dB
2f,3f,4f,5f	Harmonics	2			-30	dBm/100kHz
$IS_{21}$ $I_{OFF}$	Isolation in "OFF" State, $P_{IN} \leq +2dBm$ , $V_{EN} = 0V$		25	35		dB
$IS_{12} $	Reverse Isolation		32	42		dB
$t_R$	Rise and Fall Time 10% to 90%			1.2		$\mu s$
STAB	Stability ( $P_{IN} \leq +2dBm$ , Load VSWR = 6:1)		All non-harmonically related outputs less than -50 dBc/100kHz			

- Notes:** (1) Parameter measured with RF modulation based on IEEE 802.11b standard, meeting ACPR of -30dBc 1<sup>st</sup> lobe and -50dBc 2<sup>nd</sup> lobe  
(2) Harmonic levels and ACPR are greatly affected by topology of external matching networks.

**Typical Performance Characteristics**

Conditions: VCC = 3.3V, VCTL = 1.6V, VEN = 3.3V, F = 2.45GHz, using IEEE802.11b modulation, using SiGe SE2520L-EV1 Evaluation Board.

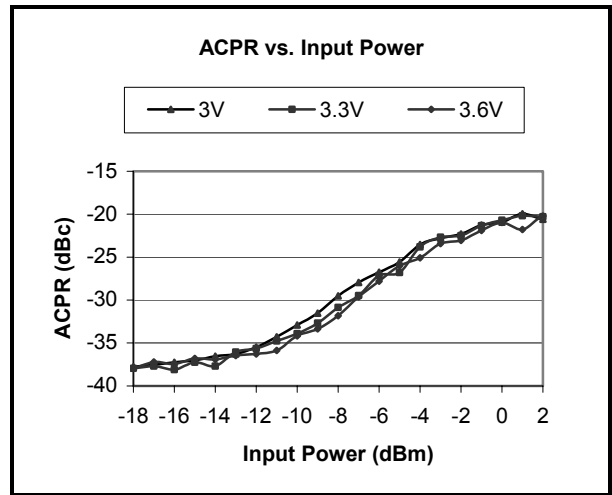
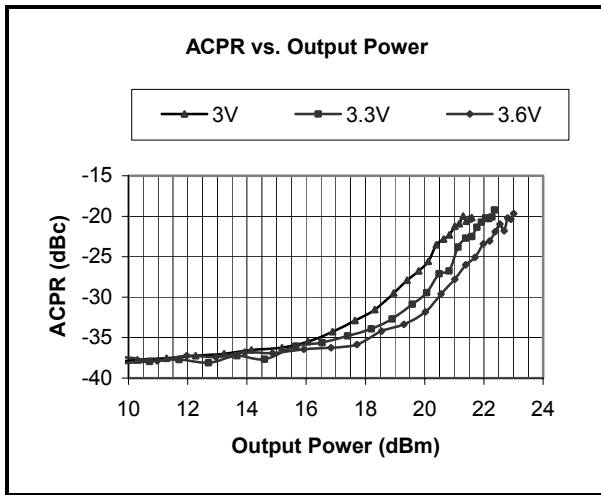
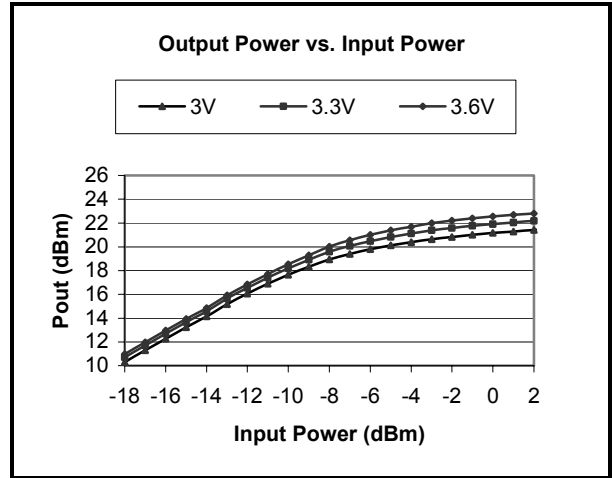
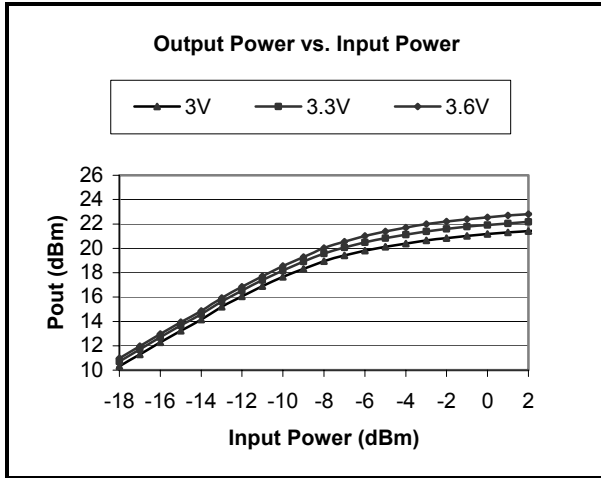

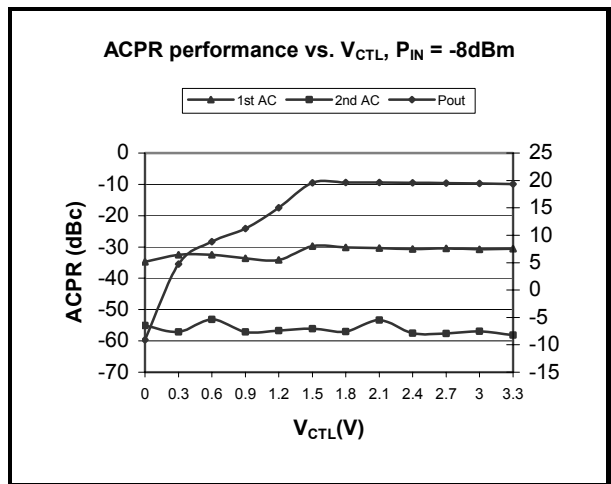
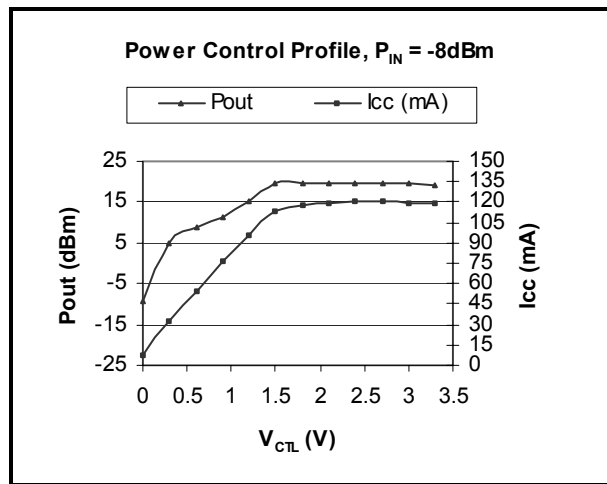
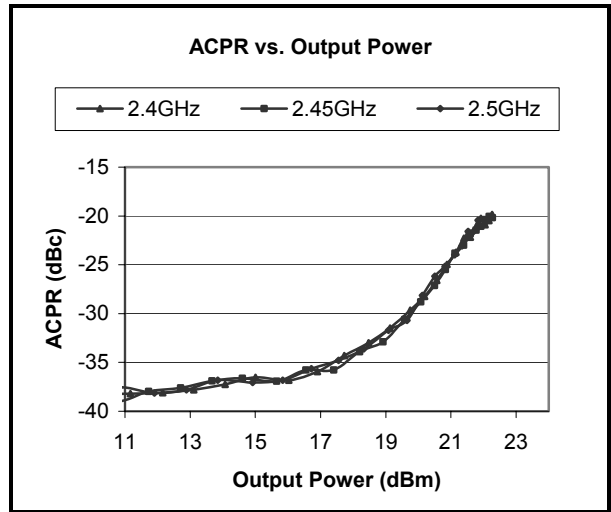
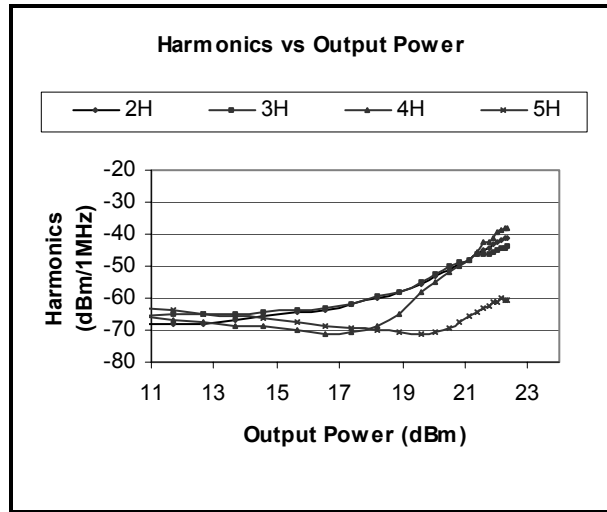

### Package Information

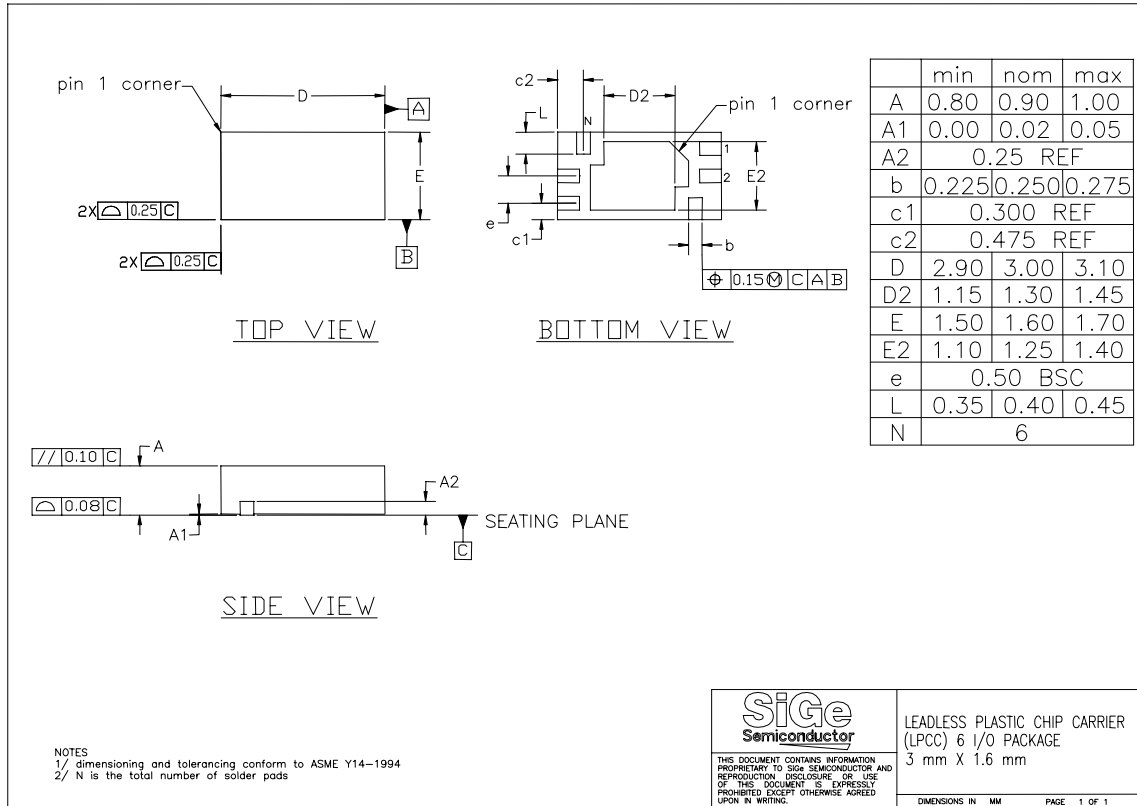

- Notes:**
1. Dimensions are in millimeters
  2. Tolerance 0.1mm unless otherwise specified
  3. Moisture/ Reflow Sensitivity Classification: Level 1 (IPC/JEDEC-J-STD-020A)
  4. Lead finish is 100% lead-free electrolytic tin.
  5. Exposed heat/electrical ground pad at bottom of package

---

<http://www.sige.com>

**Headquarters: Canada**

Phone: +1 613 820 9244

Fax: +1 613 820 4933

2680 Queensview Drive

Ottawa ON K2B 8J9 Canada

[sales@sige.com](mailto:sales@sige.com)

**San Diego**

Phone: +1 858 668 3541

Fax: +1 858 668 3546

**Hong Kong**

Phone: +1 852 9177 1917

**United Kingdom**

South Building, Walden Court  
Parsonage Lane, Bishop's Stortford  
Hertfordshire CM23 5DB

Phone: +44 1279 464 200

Fax: +44 1279 464 201

Product Preview

The datasheet contains information from the product concept specification. SiGe Semiconductor Inc. reserves the right to change information at any time without notification.

Preliminary Information

The datasheet contains information from the design target specification. SiGe Semiconductor Inc. reserves the right to change information at any time without notification.

Final

The datasheet contains information from the final product specification. SiGe Semiconductor Inc. reserves the right to change information at any time without notification. Production testing may not include testing of all parameters.

Information furnished is believed to be accurate and reliable and is provided on an "as is" basis. SiGe Semiconductor Inc. assumes no responsibility or liability for the direct or indirect consequences of use of such information nor for any infringement of patents or other rights of third parties, which may result from its use. No license or indemnity is granted by implication or otherwise under any patent or other intellectual property rights of SiGe Semiconductor Inc. or third parties. Specifications mentioned in this publication are subject to change without notice. This publication supersedes and replaces all information previously supplied. SiGe Semiconductor Inc. products are NOT authorized for use in implantation or life support applications or systems without express written approval from SiGe Semiconductor Inc.

RangerCharger™, StreamCharger™, PointCharger™, and LightCharger™ are trademarks owned by SiGe Semiconductor Inc.

Bluetooth™ logos and trademarks are owned by Bluetooth SIG Inc., USA and licensed to SiGe Semiconductor.

Copyright 2002 SiGe Semiconductor  
All Rights Reserved