

- Converts Light Intensity to Output Voltage
- Monolithic Silicon IC Containing Photodiode, Operational Amplifier, and Feedback Components
- High Sensitivity
- Single Voltage Supply Operation (2.7 V to 5.5 V)
- Low Noise (200 μ Vrms Typ to 1 kHz)
- Rail-to-Rail Output
- High Power-Supply Rejection (35 dB at 1 kHz)
- Compact 3-Leaded Plastic Package

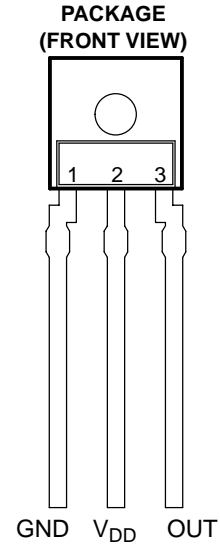

Description

The TSL257 is a high-sensitivity low-noise light-to-voltage optical converter that combines a photodiode and a transimpedance amplifier on a single monolithic CMOS integrated circuit. Output voltage is directly proportional to light intensity (irradiance) on the photodiode. The TSL257 has a transimpedance gain of 320 M Ω . The device has improved offset voltage stability and low power consumption and is supplied in a 3-lead clear plastic sidelooper package with an integral lens.

Functional Block Diagram

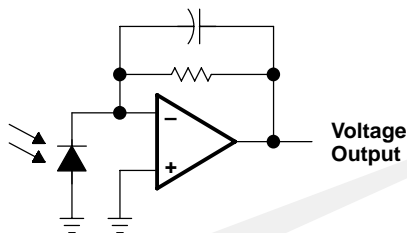

Terminal Functions

TERMINAL NAME	NO.	DESCRIPTION
GND	1	Ground (substrate). All voltages are referenced to GND.
OUT	3	Output voltage
V _{DD}	2	Supply voltage

TSL257 HIGH-SENSITIVITY LIGHT-TO-VOLTAGE CONVERTER

TAOS023A – JULY 2000

Absolute Maximum Ratings over operating free-air temperature range (unless otherwise noted)†

Supply voltage, V_{DD} (see Note 1)	6 V
Output current, I_O	± 10 mA
Duration of short-circuit current at (or below) 25°C	5 s
Operating free-air temperature range, T_A	-25°C to 85°C
Storage temperature range, T_{stg}	-25°C to 85°C
Lead temperature 1,6 mm (1/16 inch) from case for 10 seconds	240°C

† Stresses beyond those listed under “absolute maximum ratings” may cause permanent damage to the device. These are stress ratings only, and functional operation of the device at these or any other conditions beyond those indicated under “recommended operating conditions” is not implied. Exposure to absolute-maximum-rated conditions for extended periods may affect device reliability.

NOTE 1: All voltages are with respect to GND.

Recommended Operating Conditions

	MIN	MAX	UNIT
Supply voltage, V_{DD}	2.7	5.5	V
Operating free-air temperature, T_A	0	70	°C

Electrical Characteristics at $V_{DD} = 5$ V, $T_A = 25^\circ\text{C}$, $\lambda_p = 470$ nm, $R_L = 10$ k Ω (unless otherwise noted) (see Notes 2 and 3)

PARAMETER	TEST CONDITIONS	MIN	TYP	MAX	UNIT
V_D Dark voltage	$E_e = 0$	0		15	mV
V_{OM} Maximum output voltage swing	$V_{DD} = 4.5$ V, No Load		4.49		V
	$V_{DD} = 4.5$ V, $R_L = 10$ k Ω	4	4.2		
V_O Output voltage	$E_e = 1.54$ $\mu\text{W}/\text{cm}^2$, $\lambda_p = 470$ nm, Note 5	1.6	2	2.4	V
α_{VD} Temperature coefficient of dark voltage (V_D)	$T_A = 0^\circ\text{C}$ to 70°C		-15		$\mu\text{V}/^\circ\text{C}$
N_e Irradiance responsivity	$\lambda_p = 428$ nm, see Notes 4 and 8		1.18		V/($\mu\text{W}/\text{cm}^2$)
	$\lambda_p = 470$ nm, see Notes 5 and 8		1.30		
	$\lambda_p = 565$ nm, see Notes 6 and 8		1.58		
	$\lambda_p = 645$ nm, see Notes 7 and 8		1.68		
PSRR Power supply rejection ratio	$f_{ac} = 100$ Hz, see Note 9		55		dB
	$f_{ac} = 1$ kHz, see Note 9		35		dB
I_{DD} Supply current	$E_e = 1.54$ $\mu\text{W}/\text{cm}^2$, $\lambda_p = 470$ nm, Note 5		1.9	3.5	mA

- NOTES:
- Measured with $R_L = 10$ k Ω between output and ground.
 - Optical measurements are made using small-angle incident radiation from a light-emitting diode (LED) optical source.
 - The input irradiance is supplied by a GaN/SiC light-emitting diode with the following characteristics: peak wavelength $\lambda_p = 428$ nm, spectral halfwidth $\Delta\lambda_{1/2} = 65$ nm.
 - The input irradiance is supplied by an InGaN light-emitting diode with the following characteristics: peak wavelength $\lambda_p = 470$ nm, spectral halfwidth $\Delta\lambda_{1/2} = 35$ nm.
 - The input irradiance is supplied by a GaP light-emitting diode with the following characteristics: peak wavelength $\lambda_p = 565$ nm, spectral halfwidth $\Delta\lambda_{1/2} = 28$ nm.
 - The input irradiance is supplied by an AlGaAs light-emitting diode with the following characteristics: peak wavelength $\lambda_p = 645$ nm, spectral halfwidth $\Delta\lambda_{1/2} = 25$ nm.
 - Irradiance responsivity is characterized over the range $V_O = 0.1$ V to 4.5 V. The best-fit straight line of Output Voltage V_O versus Irradiance E_e over this range will typically have a positive extrapolated V_O value for $E_e = 0$.
 - Power supply rejection ratio PSRR is defined as $20 \log (\Delta V_{DD}(f)/\Delta V_O(f))$ with $V_{DD}(f = 0) = 5$ V and $V_O(f = 0) = 2$ V.

Switching Characteristics at $V_{DD} = 5\text{ V}$, $T_A = 25^\circ\text{C}$, $\lambda_p = 470\text{ nm}$, $R_L = 10\text{ k}\Omega$ (unless otherwise noted)

PARAMETER	TEST CONDITIONS	MIN	TYP	MAX	UNIT
t_r Output pulse rise time, 10% to 90% of final value	See Note 10 and Figure 1		160	250	μs
t_f Output pulse fall time, 10% to 90% of final value	See Note 10 and Figure 1		150	250	μs
t_s Output settling time to 1% of final value	See Note 10 and Figure 1		330		μs
Integrated noise voltage	$f = \text{dc to } 1\text{ kHz}$ $E_e = 0$		200		μVrms
V_n Output noise voltage, rms	$f = 10\text{ Hz}$ $E_e = 0$		6		$\mu\text{V}/\sqrt{\text{Hz}}$ rms
	$f = 100\text{ Hz}$ $E_e = 0$		6		
	$f = 1\text{ kHz}$ $E_e = 0$		7		

NOTE 10: Switching characteristics apply over the range $V_O = 0.1\text{ V}$ to 4.5 V .

PARAMETER MEASUREMENT INFORMATION

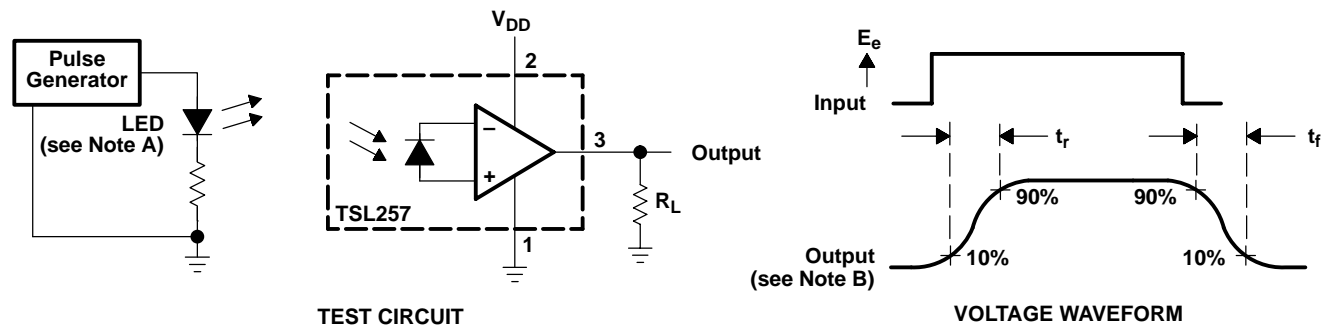

- NOTES: A. The input irradiance is supplied by a pulsed InGaN light-emitting diode with the following characteristics: $\lambda_p = 470\text{ nm}$, $t_r < 1\text{ }\mu\text{s}$, $t_f < 1\text{ }\mu\text{s}$.
- B. The output waveform is monitored on an oscilloscope with the following characteristics: $t_r < 100\text{ ns}$, $Z_i \geq 1\text{ M}\Omega$, $C_i \leq 20\text{ pF}$.

Figure 1. Switching Times

TSL257
HIGH-SENSITIVITY
LIGHT-TO-VOLTAGE CONVERTER

TAOS023A – JULY 2000

TYPICAL CHARACTERISTICS

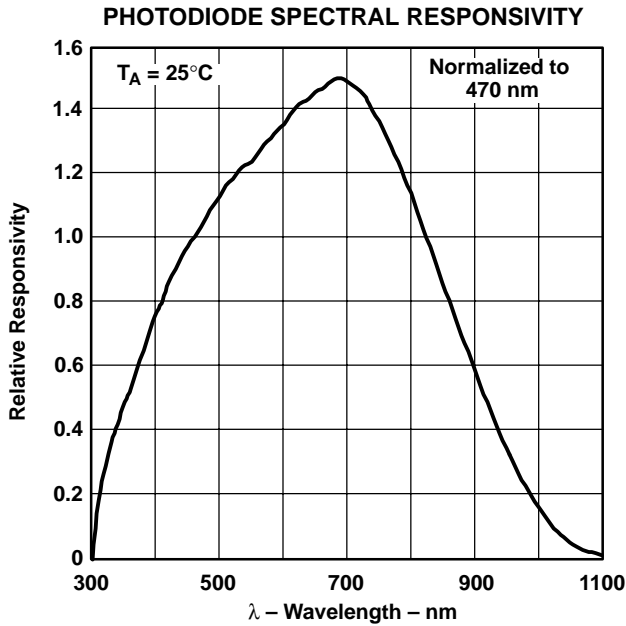

Figure 2

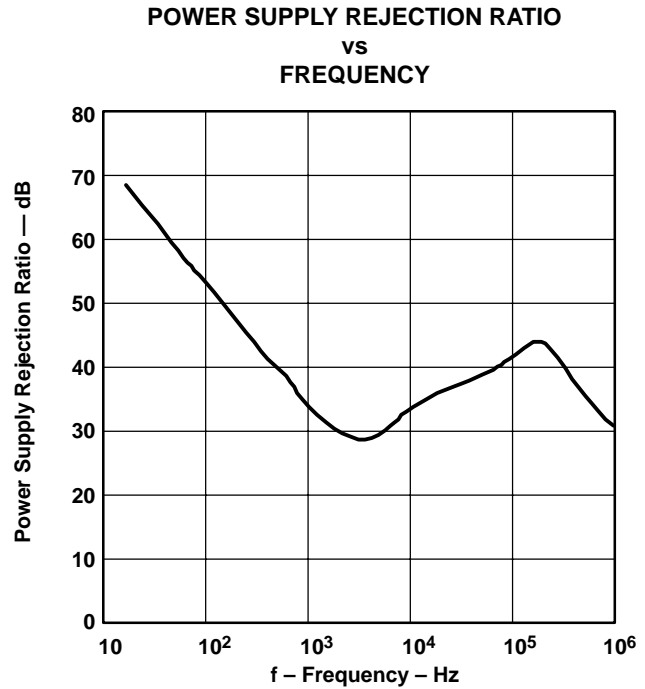

Figure 3

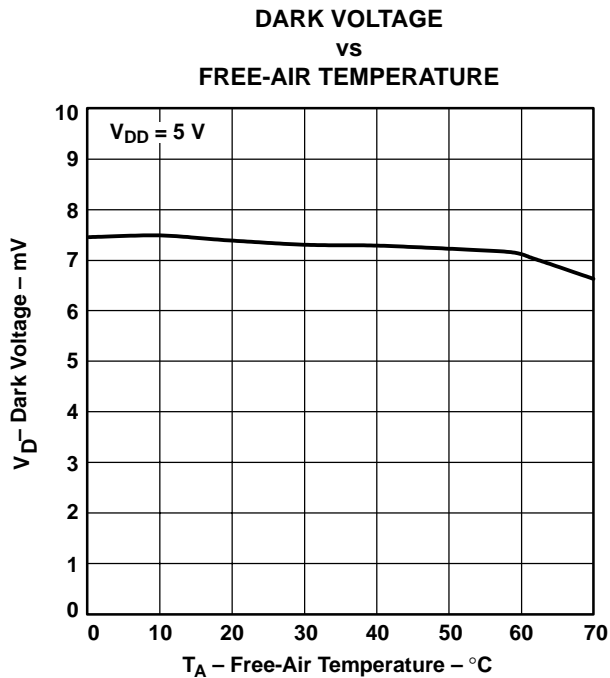

Figure 4

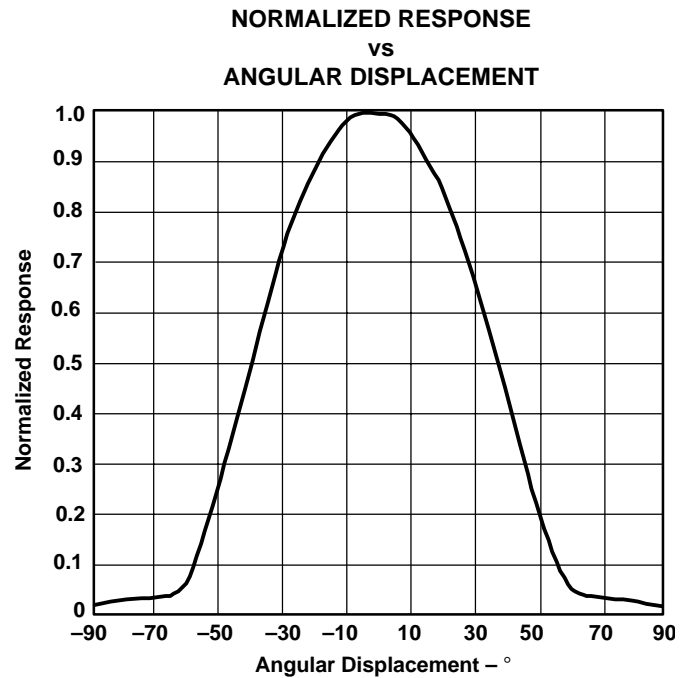

Figure 5

MECHANICAL DATA

The TSL257 is implemented in a clear 3-leaded package with a molded focusing lens.

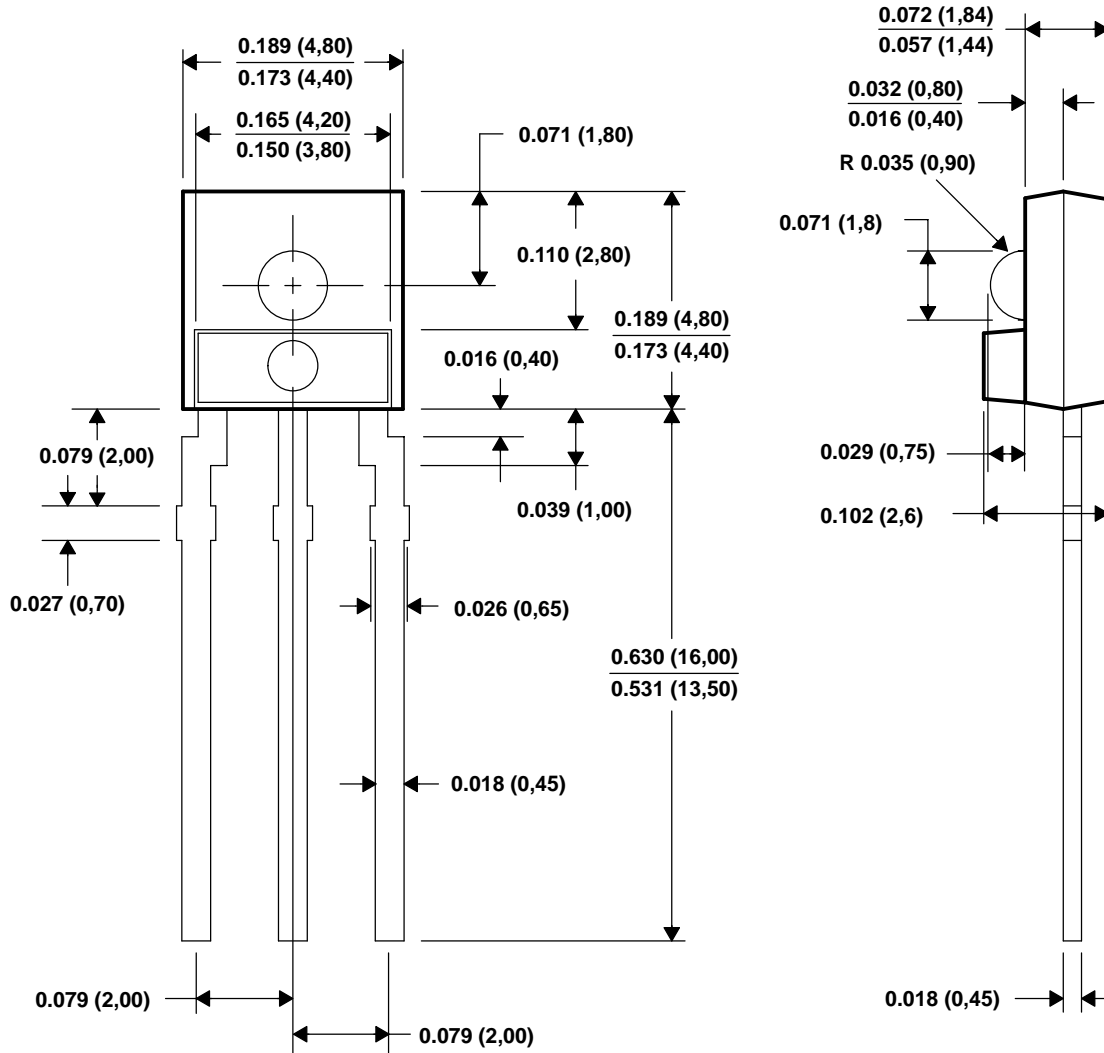

Figure 6. Package Configuration

- NOTES:
- A. All linear dimensions are in inches (millimeters).
 - B. This drawing is subject to change without notice.
 - C. All dimensions apply before solder dip.
 - D. Package body is a clear nonfilled optically transparent material
 - E. Index of refraction of clear plastic is 1.55.

TSL257 HIGH-SENSITIVITY LIGHT-TO-VOLTAGE CONVERTER

TAOS023A – JULY 2000

PRODUCTION DATA — information in this document is current at publication date. Products conform to specifications in accordance with the terms of Texas Advanced Optoelectronic Solutions, Inc. standard warranty. Production processing does not necessarily include testing of all parameters.

NOTICE

Texas Advanced Optoelectronic Solutions, Inc. (TAOS) reserves the right to make changes to the products contained in this document to improve performance or for any other purpose, or to discontinue them without notice. Customers are advised to contact TAOS to obtain the latest product information before placing orders or designing TAOS products into systems.

TAOS assumes no responsibility for the use of any products or circuits described in this document or customer product design, conveys no license, either expressed or implied, under any patent or other right, and makes no representation that the circuits are free of patent infringement. TAOS further makes no claim as to the suitability of its products for any particular purpose, nor does TAOS assume any liability arising out of the use of any product or circuit, and specifically disclaims any and all liability, including without limitation consequential or incidental damages.

TEXAS ADVANCED OPTOELECTRONIC SOLUTIONS, INC. PRODUCTS ARE NOT DESIGNED OR INTENDED FOR USE IN CRITICAL APPLICATIONS IN WHICH THE FAILURE OR MALFUNCTION OF THE TAOS PRODUCT MAY RESULT IN PERSONAL INJURY OR DEATH. USE OF TAOS PRODUCTS IN LIFE SUPPORT SYSTEMS IS EXPRESSLY UNAUTHORIZED AND ANY SUCH USE BY A CUSTOMER IS COMPLETELY AT THE CUSTOMER'S RISK.

TAOS, the TAOS logo, and Texas Advanced Optoelectronic Solutions are trademarks of Texas Advanced Optoelectronic Solutions Incorporated.