

Surface Mount RF PIN Low Distortion Attenuator Diodes

Technical Data

HSMP-381x Series and HSMP-481x Series

Features

- **Diodes Optimized for:**
 - Low Distortion Attenuating Operation
 - Microwave Frequency Operation
- **Surface Mount Packages**
 - Single and Dual Versions
 - Tape and Reel Options Available
- **Low Failure in Time (FIT) Rate^[1]**
- **Lead-free Option Available**

Note:

1. For more information see the Surface Mount PIN Reliability Data Sheet.

Description/Applications

The HSMP-381x series is specifically designed for low distortion attenuator applications. The HSMP-481x products feature ultra low parasitic inductance in the SOT-23 and SOT-323 packages. They are specifically designed for use at frequencies which are much higher than the upper limit for conventional diodes.

A SPICE model is not available for PIN diodes as SPICE does not provide for a key PIN diode characteristic, carrier lifetime.

Package Lead Code Identification, SOT-23 (Top View)

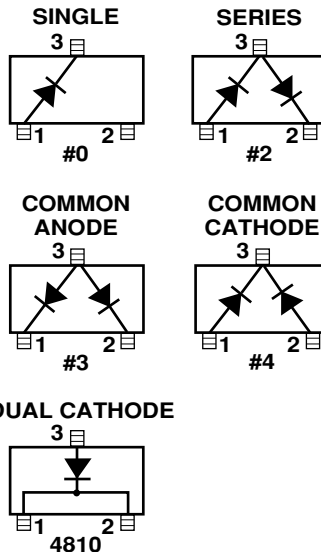

Package Lead Code Identification, SOT-323 (Top View)

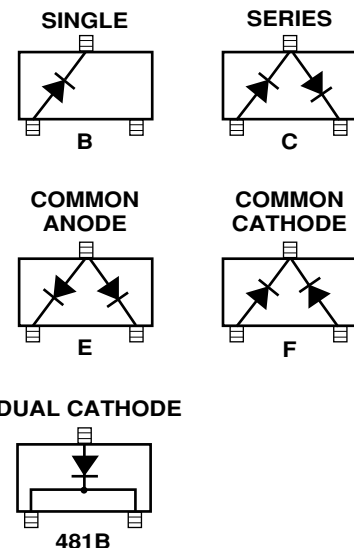

Absolute Maximum Ratings^[1] $T_C = +25^\circ\text{C}$

Symbol	Parameter	Unit	SOT-23	SOT-323
I_F	Forward Current (1 μs Pulse)	Amp	1	1
P_{IV}	Peak Inverse Voltage	V	Same as V_{BR}	Same as V_{BR}
T_j	Junction Temperature	$^\circ\text{C}$	150	150
T_{stg}	Storage Temperature	$^\circ\text{C}$	-65 to 150	-65 to 150
θ_{jc}	Thermal Resistance ^[2]	$^\circ\text{C}/\text{W}$	500	150

Notes:

1. Operation in excess of any one of these conditions may result in permanent damage to the device.
2. $T_C = +25^\circ\text{C}$, where T_C is defined to be the temperature at the package pins where contact is made to the circuit board.

Electrical Specifications $T_C = +25^\circ\text{C}$ (Each Diode)

Conventional Diodes

Part Number HSMP-	Package Marking Code	Lead Code	Configuration	Minimum Breakdown Voltage V_{BR} (V)	Maximum Total Resistance R_T (Ω)	Maximum Total Capacitance C_T (pF)	Minimum High Resistance R_H (Ω)	Maximum Low Resistance R_L (Ω)
3810	E0 ^[1]	0	Single	100	3.0	0.35	1500	10
3812	E2 ^[1]	2	Series					
3813	E3 ^[1]	3	Common Anode					
3814	E4 ^[1]	4	Common Cathode					
381B	E0 ^[2]	B	Single					
381C	E2 ^[2]	C	Series					
381E	E3 ^[2]	E	Common Anode					
381F	E4 ^[2]	F	Common Cathode					
Test Conditions				$V_R = V_{BR}$ Measure $I_R \leq 10 \mu\text{A}$	$I_F = 100 \text{ mA}$ $f = 100 \text{ MHz}$	$V_R = 50 \text{ V}$ $f = 1 \text{ MHz}$	$I_R = 0.01 \text{ mA}$ $f = 100 \text{ MHz}$	$I_F = 20 \text{ mA}$ $f = 100 \text{ MHz}$

High Frequency (Low Inductance, 500 MHz – 3 GHz) PIN Diodes

Part Number HSMP-	Package Marking Code	Lead Code	Configuration	Minimum Breakdown Voltage V_{BR} (V)	Maximum Series Resistance R_S (Ω)	Typical Total Capacitance C_T (pF)	Maximum Total Capacitance C_T (pF)	Typical Total Inductance L_T (nH)
4810	EB	B ^[1]	Dual Cathode	100	3.0	0.35	0.4	1.0
481B	EB	B ^[2]	Dual Cathode					
Test Conditions				$V_R = V_{BR}$ Measure $I_R \leq 10 \mu\text{A}$	$I_F = 100 \text{ mA}$	$V_R = 50 \text{ V}$ $f = 1 \text{ MHz}$	$V_R = 50 \text{ V}$ $f = 1 \text{ MHz}$ $V_R = 0 \text{ V}$	$f = 500 \text{ MHz} - 3 \text{ GHz}$

Notes:

1. Package marking code is white.
2. Package laser marked.

Typical Parameters at $T_C = 25^\circ\text{C}$

Part Number HSMP-	Series Resistance R_S (Ω)	Carrier Lifetime τ (ns)	Reverse Recovery Time T_{rr} (ns)	Total Capacitance C_T (pF)
381x	75	1500	300	0.27 @ 50 V
Test Conditions	$I_F = 1$ mA $f = 100$ MHz	$I_F = 50$ mA $I_R = 250$ mA	$V_R = 10$ V $I_F = 20$ mA 90% Recovery	$f = 1$ MHz

Typical Parameters at $T_C = 25^\circ\text{C}$ (unless otherwise noted), Single Diode

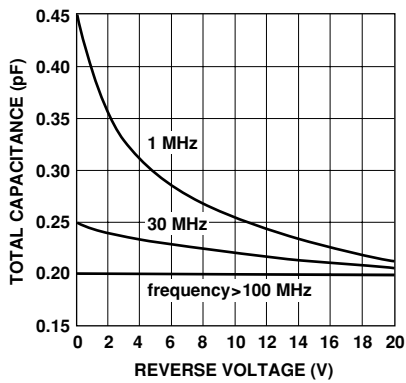

Figure 1. RF Capacitance vs. Reverse Bias.

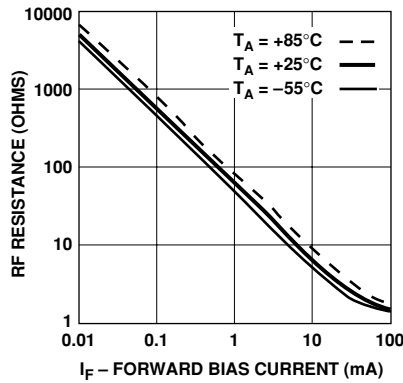

Figure 2. RF Resistance vs. Forward Bias Current.

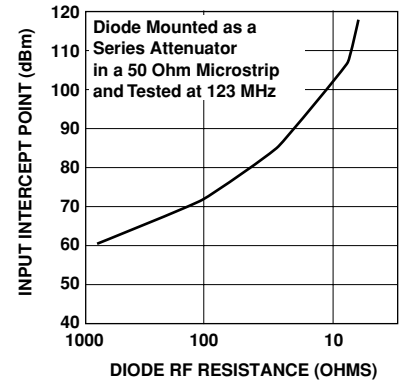

Figure 3. 2nd Harmonic Input Intercept Point vs. Diode RF Resistance.

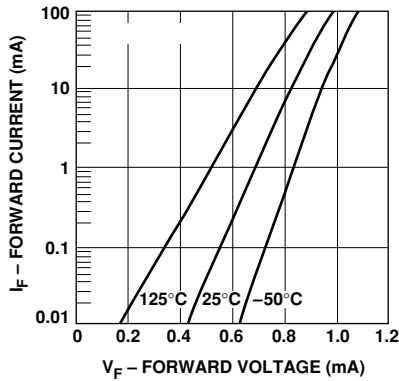

Figure 4. Forward Current vs. Forward Voltage.

Typical Applications for Multiple Diode Products

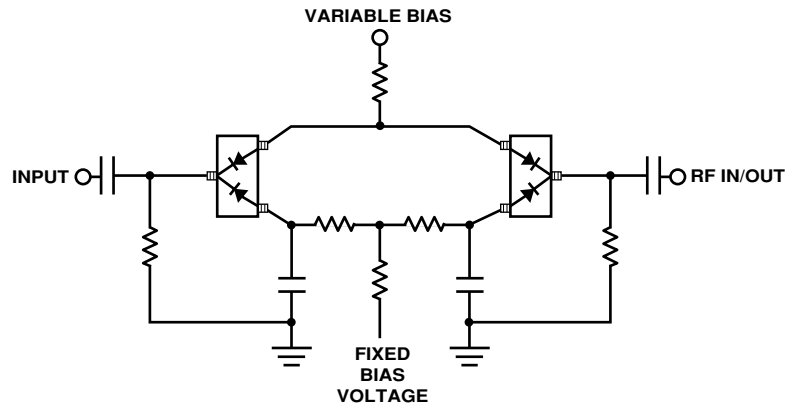

Figure 5. Four Diode π Attenuator. See Application Note 1048 for Details.

Typical Applications for HSMP-481x Low Inductance Series

Microstrip Series Connection for HSMP-481x Series

In order to take full advantage of the low inductance of the HSMP-481x series when using them in series applications, both lead 1 and lead 2 should be connected together, as shown in Figure 7.

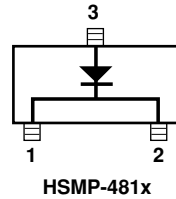

Figure 6. Internal Connections.

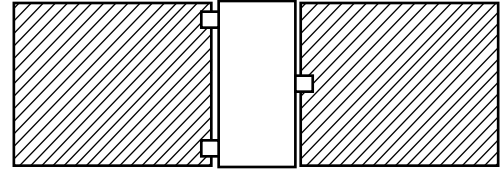

Figure 7. Circuit Layout.

Microstrip Shunt Connections for HSMP-481x Series

In Figure 8, the center conductor of the microstrip line is interrupted and leads 1 and 2 of the HSMP-481x series diode are placed across the resulting gap. This forces the 1.5 nH lead inductance of leads 1 and 2 to appear as part of a low pass filter, reducing the shunt parasitic inductance and increasing the maximum available attenuation. The 0.3 nH of shunt inductance external to the diode is created by the via holes, and is a good estimate for 0.032" thick material.

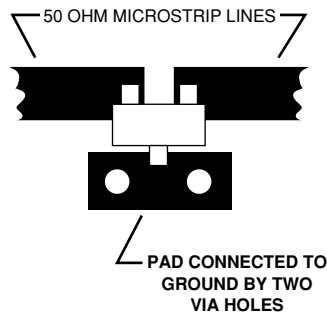

Figure 8. Circuit Layout.

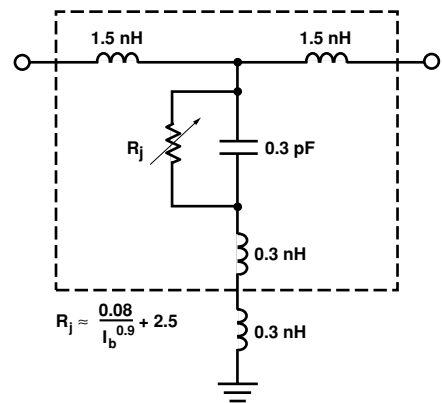

Figure 9. Equivalent Circuit.

Typical Applications for HSMP-481x Low Inductance Series (continued)

Co-Planar Waveguide Shunt Connection for HSMP-481x Series

Co-Planar waveguide, with ground on the top side of the printed circuit board, is shown in Figure 10. Since it eliminates the need for via holes to ground, it offers lower shunt parasitic inductance and higher maximum attenuation when compared to a microstrip circuit.

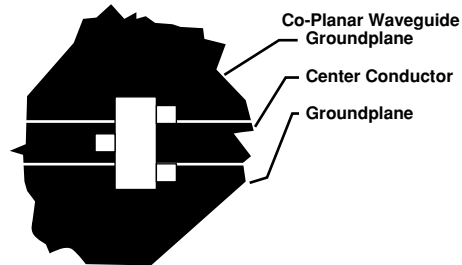

Figure 10. Circuit Layout.

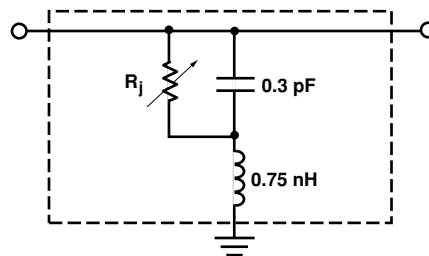
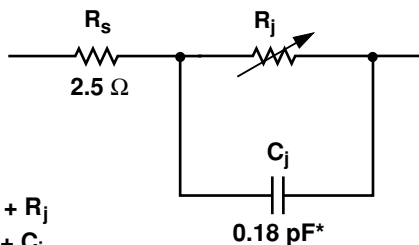

Figure 11. Equivalent Circuit.

Equivalent Circuit Model HSMS-381x Chip*



$$R_T = 2.5 + R_j$$

$$C_T = C_p + C_j$$

$$R_j = \frac{80}{I^{0.9}} \Omega$$

* Measured at -20 V

I = Forward Bias Current in mA

*See AN1124 for package models.

Assembly Information

SOT-323 PCB Footprint

A recommended PCB pad layout for the miniature SOT-323 (SC-70) package is shown in Figure 12 (dimensions are in inches). This layout provides ample allowance for package placement by automated assembly equipment without adding parasitics that could impair the performance.

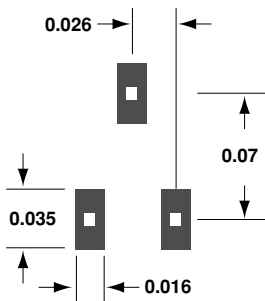

Figure 12. PCB Pad Layout (dimensions in inches).

SOT-23 PCB Footprint

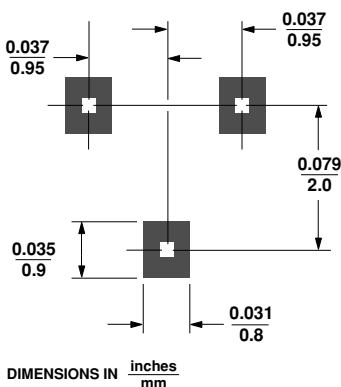

Figure 13. PCB Pad Layout.

SMT Assembly

Reliable assembly of surface mount components is a complex process that involves many material, process, and equipment factors, including: method of heating (e.g., IR or vapor phase reflow, wave soldering, etc.) circuit board material, conductor thickness and pattern, type of solder alloy, and the thermal conductivity and thermal mass of components. Components with a low mass, such as the SOT-323/-23 package, will reach solder reflow temperatures faster than those with a greater mass.

Agilent's diodes have been qualified to the time-temperature profile shown in Figure 14. This profile is representative of an IR reflow type of surface mount assembly process.

After ramping up from room temperature, the circuit board with components attached to it (held in place with solder paste)

passes through one or more preheat zones. The preheat zones increase the temperature of the board and components to prevent thermal shock and begin evaporating solvents from the solder paste. The reflow zone briefly elevates the temperature sufficiently to produce a reflow of the solder.

The rates of change of temperature for the ramp-up and cool-down zones are chosen to be low enough to not cause deformation of the board or damage to components due to thermal shock. The maximum temperature in the reflow zone (T_{MAX}) should not exceed 235°C.

These parameters are typical for a surface mount assembly process for Agilent diodes. As a general guideline, the circuit board and components should be exposed only to the minimum temperatures and times necessary to achieve a uniform reflow of solder.

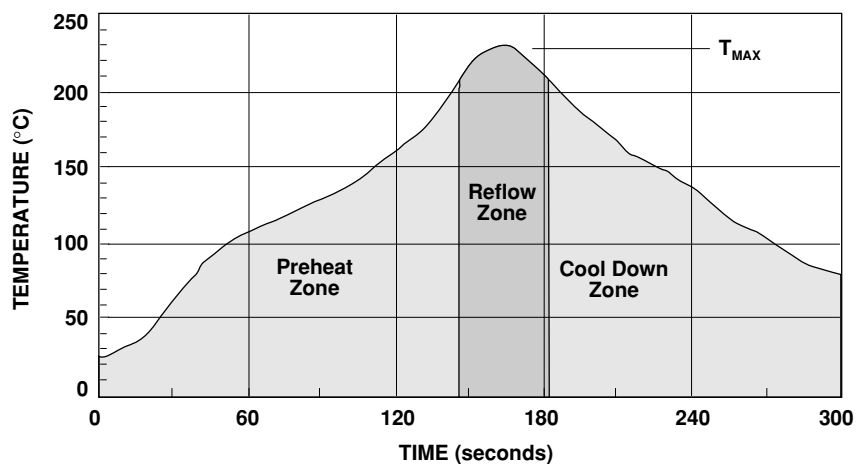
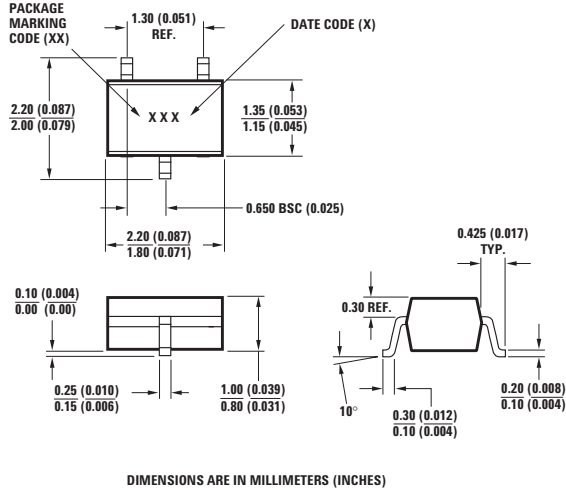
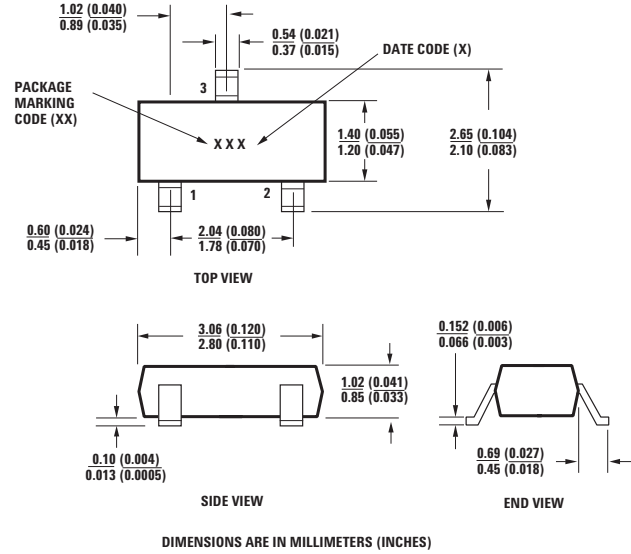

Figure 14. Surface Mount Assembly Profile.

Package Dimensions Outline SOT-323 (SC-70)



Outline 23 (SOT-23)



Package Characteristics

- Lead Material Copper (SOT-323); Alloy 42 (SOT-23)
- Lead Finish Tin-Lead 85-15%
- Maximum Soldering Temperature 260°C for 5 seconds
- Minimum Lead Strength 2 pounds pull
- Typical Package Inductance 2 nH
- Typical Package Capacitance 0.08 pF (opposite leads)

Ordering Information

Specify part number followed by option. For example:

HSMP - 381x - XXX

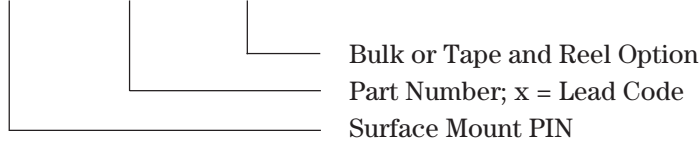

Option Descriptions

- BLK = Bulk, 100 pcs. per antistatic bag
- TR1 = Tape and Reel, 3000 devices per 7" reel
- TR2 = Tape and Reel, 10,000 devices per 13" reel

Tape and Reeling conforms to Electronic Industries RS-481, "Taping of Surface Mounted Components for Automated Placement."

For lead-free option, the part number will have the character "G" at the end, eg. -TR2G for a 10K pc lead-free reel.

Device Orientation For Outlines SOT-23/323

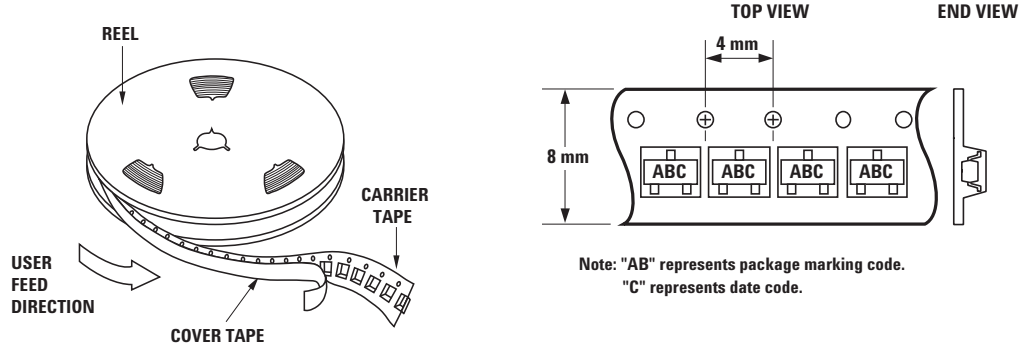

Tape Dimensions and Product Orientation For Outline SOT-23

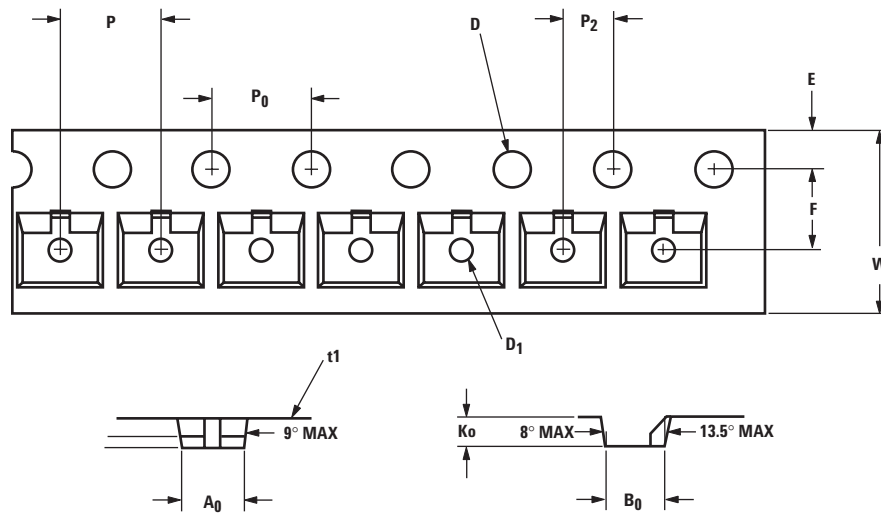

	DESCRIPTION	SYMBOL	SIZE (mm)	SIZE (INCHES)
CAVITY	LENGTH	A ₀	3.15 ± 0.10	0.124 ± 0.004
	WIDTH	B ₀	2.77 ± 0.10	0.109 ± 0.004
	DEPTH	K ₀	1.22 ± 0.10	0.048 ± 0.004
	PITCH	P	4.00 ± 0.10	0.157 ± 0.004
	BOTTOM HOLE DIAMETER	D ₁	1.00 + 0.05	0.039 ± 0.002
	PERFORATION	DIAMETER	D	1.50 + 0.10
PITCH		P ₀	4.00 ± 0.10	0.157 ± 0.004
POSITION		E	1.75 ± 0.10	0.069 ± 0.004
CARRIER TAPE	WIDTH	W	8.00 + 0.30 - 0.10	0.315 + 0.012 - 0.004
	THICKNESS	t ₁	0.229 ± 0.013	0.009 ± 0.0005
DISTANCE BETWEEN CENTERLINE	CAVITY TO PERFORATION (WIDTH DIRECTION)	F	3.50 ± 0.05	0.138 ± 0.002
	CAVITY TO PERFORATION (LENGTH DIRECTION)	P ₂	2.00 ± 0.05	0.079 ± 0.002

Tape Dimensions and Product Orientation For Outline SOT-323

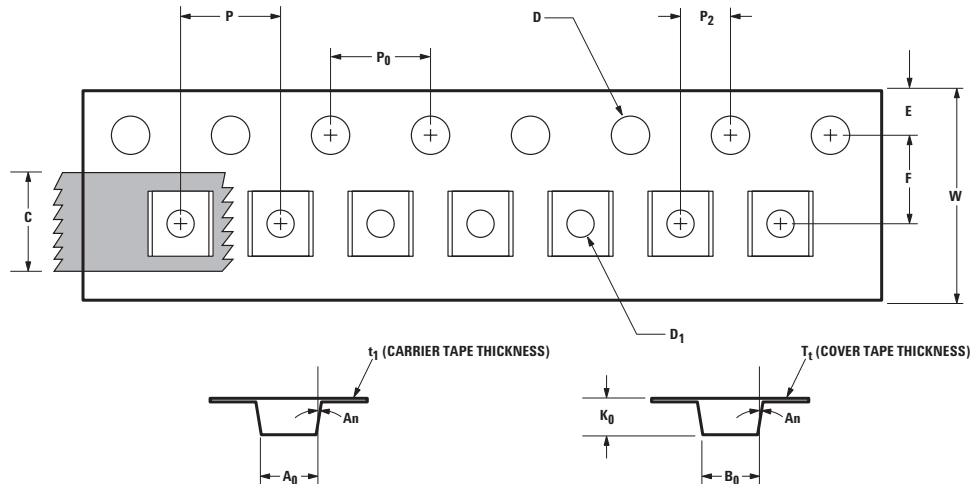

	DESCRIPTION	SYMBOL	SIZE (mm)	SIZE (INCHES)
CAVITY	LENGTH	A_0	2.40 ± 0.10	0.094 ± 0.004
	WIDTH	B_0	2.40 ± 0.10	0.094 ± 0.004
	DEPTH	K_0	1.20 ± 0.10	0.047 ± 0.004
	PITCH	P	4.00 ± 0.10	0.157 ± 0.004
	BOTTOM HOLE DIAMETER	D_1	$1.00 + 0.25$	$0.039 + 0.010$
PERFORATION	DIAMETER	D	1.55 ± 0.05	0.061 ± 0.002
	PITCH	P_0	4.00 ± 0.10	0.157 ± 0.004
	POSITION	E	1.75 ± 0.10	0.069 ± 0.004
CARRIER TAPE	WIDTH	W	8.00 ± 0.30	0.315 ± 0.012
	THICKNESS	t_1	0.254 ± 0.02	0.0100 ± 0.0008
COVER TAPE	WIDTH	C	5.4 ± 0.10	0.205 ± 0.004
	TAPE THICKNESS	T_t	0.062 ± 0.001	0.0025 ± 0.00004
DISTANCE	CAVITY TO PERFORATION (WIDTH DIRECTION)	F	3.50 ± 0.05	0.138 ± 0.002
	CAVITY TO PERFORATION (LENGTH DIRECTION)	P_2	2.00 ± 0.05	0.079 ± 0.002
ANGLE	FOR SOT-323 (SC70-3 LEAD) FOR SOT-363 (SC70-6 LEAD)	A_n	8°C MAX 10°C MAX	

www.agilent.com/semiconductors

For product information and a complete list of distributors, please go to our web site.

For technical assistance call:

Americas/Canada: +1 (800) 235-0312 or
(916) 788-6763

Europe: +49 (0) 6441 92460

China: 10800 650 0017

Hong Kong: (65) 6756 2394

India, Australia, New Zealand: (65) 6755 1939

Japan: (+81 3) 3335-8152(Domestic/International), or
0120-61-1280(Domestic Only)

Korea: (65) 6755 1989

Singapore, Malaysia, Vietnam, Thailand, Philippines,
Indonesia: (65) 6755 2044

Taiwan: (65) 6755 1843

Data subject to change.

Copyright © 2004 Agilent Technologies, Inc.

Obsoletes 5968-5427E

March 24, 2004

5989-0482EN

This datasheet has been download from:

www.datasheetcatalog.com

Datasheets for electronics components.