

Typical Applications

The HMC141LH5 is ideal for:

- Telecom Infrastructure
- Military Radio, Radar & ECM
- Space Systems
- Test Instrumentation

Features

- Input IP3: +20 dBm
- LO to RF Isolation: 35 dB
- Hermetic SMT Package, 25 mm²
- Screening to MIL-PRF-38535 (Class B or S) Available

Functional Diagram

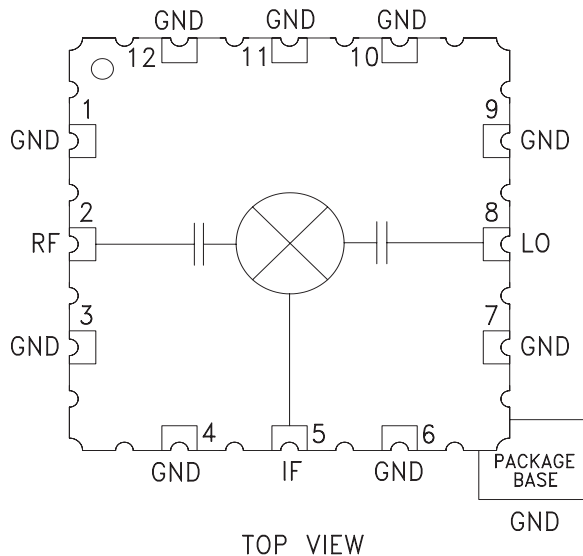

General Description

The HMC141LH5 is a miniature passive double-balanced mixer housed in a hermetic SMT leadless package that can be used as an upconverter or downconverter. The device is a passive diode/balun type mixer with high dynamic range. The mixer can handle larger signal levels than most active mixers due to the high third order intercept of 20 dBm. MMIC implementation provides exceptional balance in the circuit resulting in high LO/RF and LO/IF isolations and unit-to-unit consistency. The HMC141LH5 allows the use of surface mount manufacturing techniques and is suitable for high reliability military, industrial and space applications.

Electrical Specifications, $T_A = +25^\circ\text{C}$, LO Drive = +15 dBm*

Parameter	Min.	Typ.	Max.	Min.	Typ.	Max.	Units
Frequency Range, RF & LO	7 - 12			12 - 14			GHz
Frequency Range, IF	DC - 2			DC - 2			GHz
Conversion Loss		10	12		11	13	dB
Noise Figure (SSB)		10	12		11	13	dB
LO to RF Isolation	28	35		28	35		dB
LO to IF Isolation	26	34		26	31		dB
IP3 (Input)		20			23		dBm
IP2 (Input)		35			40		dBm
1 dB Gain Compression (Input)		15			15		dBm

*Unless otherwise noted, all measurements performed as downconverter, IF = 1 GHz



GaAs MMIC SMT DOUBLE-BALANCED MIXER, 7 - 14 GHz

Conversion Gain vs. Temperature @ LO = +15 dBm

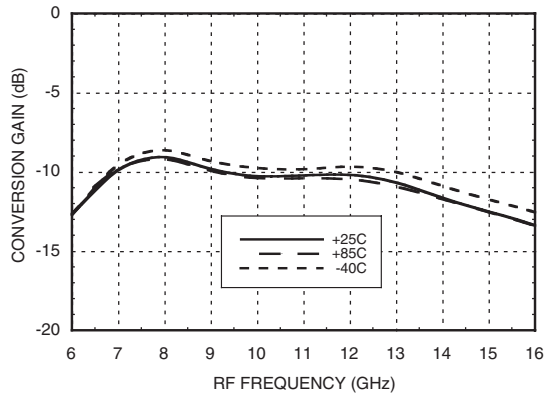

Isolation @ LO = +15 dBm

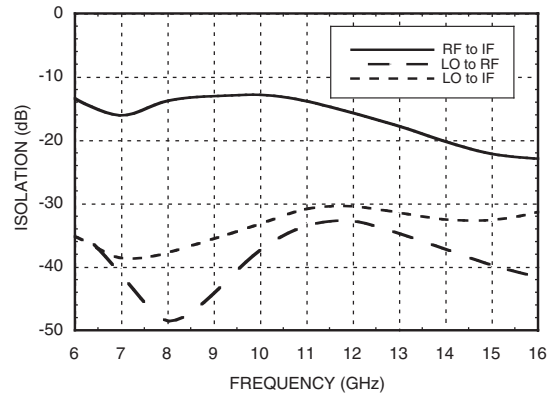

Conversion Gain vs. LO Drive

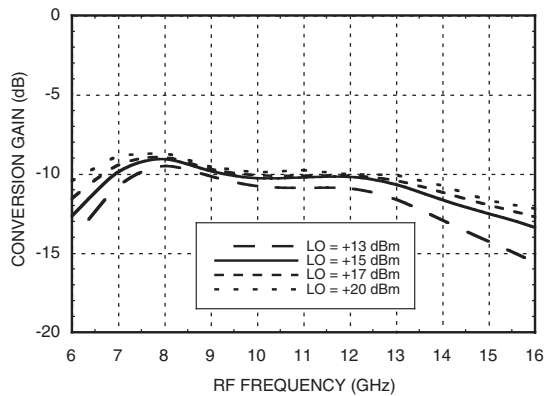

Return Loss @ LO = +15 dBm

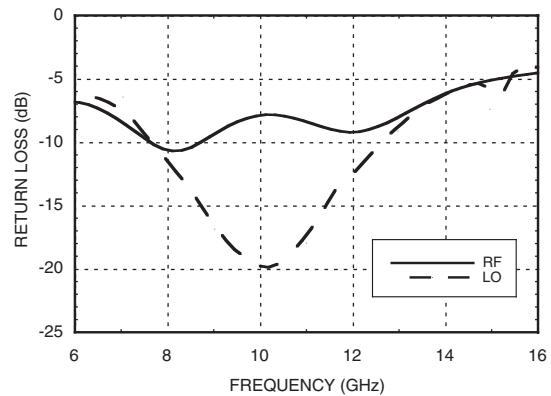

IF Bandwidth @ LO = +15 dBm

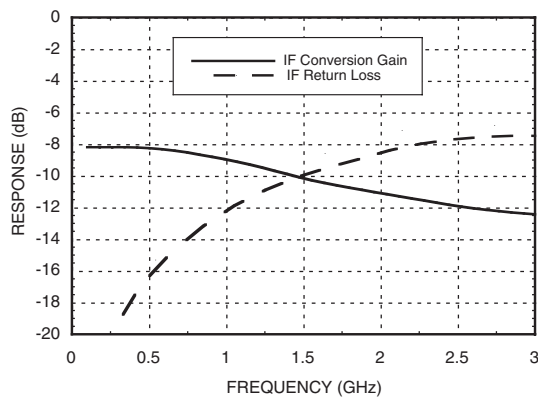

Upconverter Performance Conversion Gain @ LO = +15 dBm

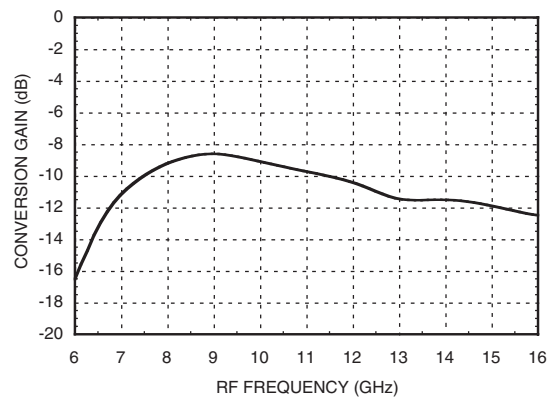

GaAs MMIC SMT DOUBLE-BALANCED MIXER, 7 - 14 GHz

Input IP3 vs. LO Drive*

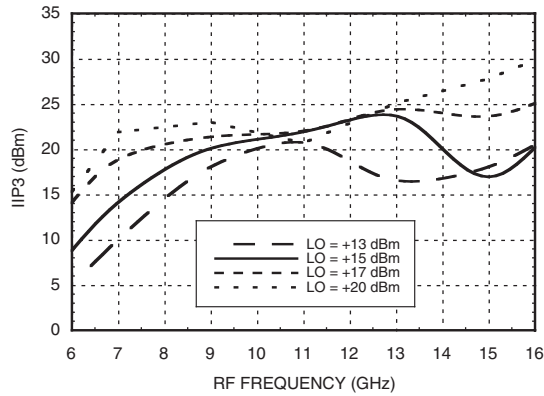

Input IP3 vs. Temperature @ LO = +15 dBm*

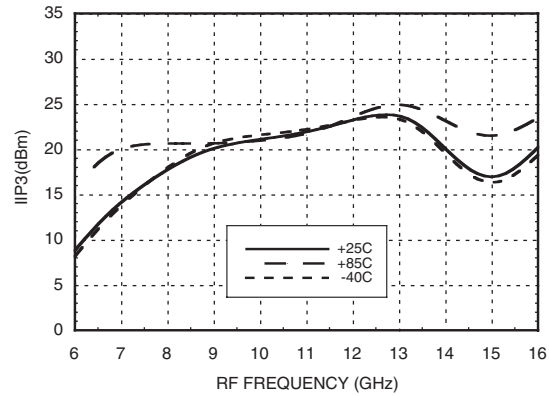

Input IP2 vs. LO Drive*

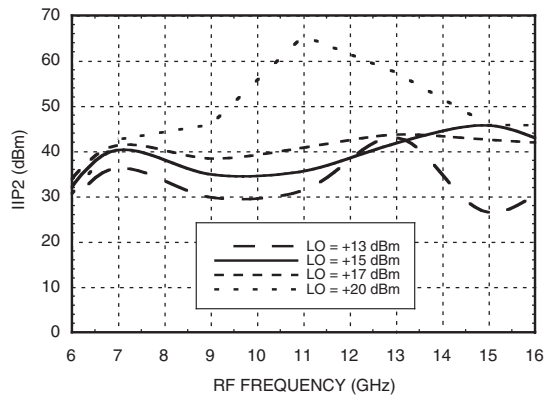

Input P1dB vs. Temperature @ LO = +15 dBm

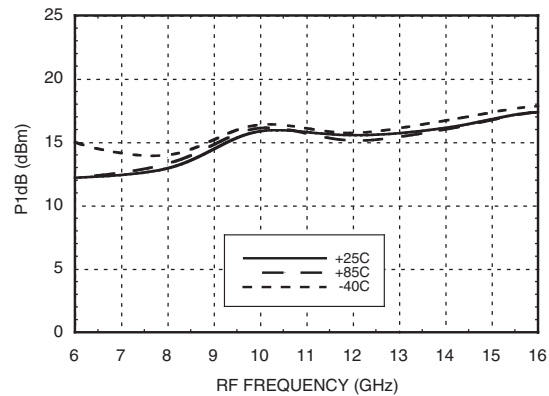

MxN Spurious @ IF Port

mRF	nLO				
	0	1	2	3	4
0	XX	-1	6	9	30
1	6	0	20	40	37
2	68	63	55	53	79
3	94	95	87	76	90
4	88	100	96	99	104

RF = 10 GHz @ -10 dBm
 LO = 8.9 GHz @ 20 dBm
 All values in dBc relative to the IF power level.
 Measured as downconverter.

Harmonics of LO

LO Freq. (GHz)	nLO Spur @ RF Port			
	1	2	3	4
6	44	40	61	53
8	46	32	59	52
10	38	25	52	59
12	39	32	55	64
14	43	34	54	N/A
16	39	34	53	N/A

LO = +20 dBm
 All values in dBc below input LO level @ RF port.

* Two-tone input power = 0 dBm each tone, 1 MHz spacing.

Absolute Maximum Ratings

RF / IF Input	+13 dBm
LO Drive	+27 dBm
IF DC Current	±2 mA
Channel Temperature	150 °C
Continuous Pdiss (T = 85 °C) (derate 9.83 mW/°C above 85 °C)	640 mW
Thermal Resistance (R _{TH}) (Channel to package bottom)	101.7 °C/W
Storage Temperature	-65 to +150 °C
Operating Temperature	-40 to +85 °C
ESD Sensitivity (HBM)	Class 1A



ELECTROSTATIC SENSITIVE DEVICE
OBSERVE HANDLING PRECAUTIONS

Outline Drawing

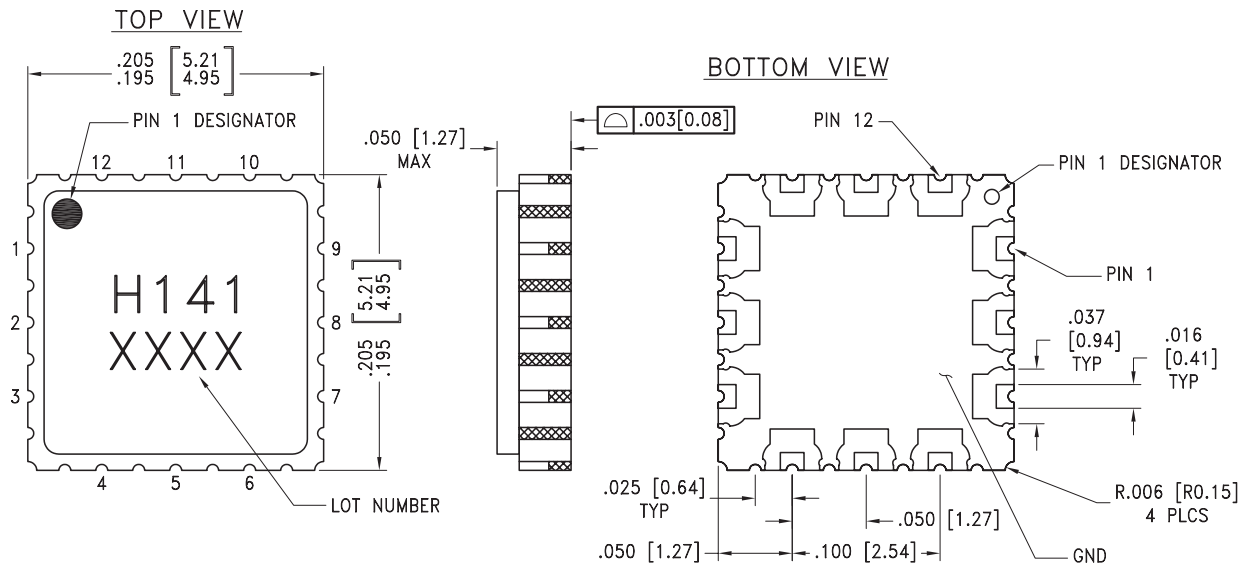

NOTES:

1. PACKAGE BODY MATERIAL: CERAMIC & KOVAR
2. LEAD AND GROUND PADDLE PLATING: GOLD 40-80 MICROINCHES
3. DIMENSIONS ARE IN INCHES [MILLIMETERS].
4. LEAD SPACING TOLERANCE IS NON-CUMULATIVE.
5. PAD BURR LENGTH 0.15mm MAX. PAD BURR HEIGHT 0.25mm MAX
6. ALL GROUND LEADS AND GROUND PADDLE MUST BE SOLDERED TO PCB RF GROUND.

Pin Descriptions

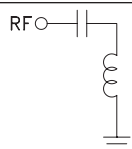
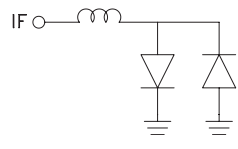
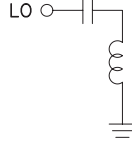
Pin Number	Function	Description	Interface Schematic
1, 3, 4, 6, 7 9 - 12	GND	These pins and package base must be connected to RF/DC ground.	
2	RF	This pin is AC coupled and matched to 50 Ohms from 7 - 14 GHz	
5	IF	This pin is DC coupled. For applications not requiring operation to DC, this port should be DC blocked externally using a series capacitor whose value has been chosen to pass the necessary IF frequency range. For operation to DC, this pin must not source/sink more than 2 mA of current or die non-function and possible die failure will result.	
8	LO	This pin is AC coupled and matched to 50 Ohms from 7 - 14 GHz	

Evaluation PCB

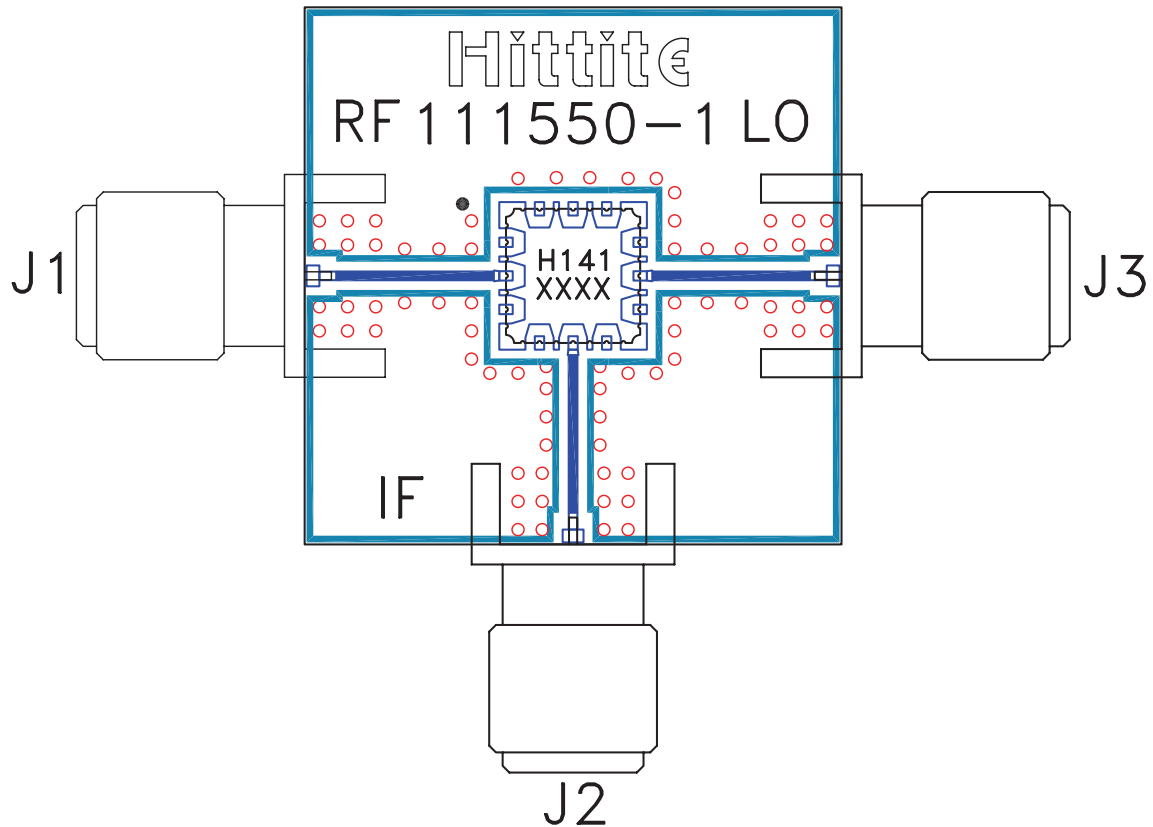

List of Materials for Evaluation PCB 111552 [1]

Item	Description
J1 - J3	PCB Mount SMA RF Connector, SRI
U1	HMC141LH5
PCB [2]	111550 Evaluation Board

[1] Reference this number when ordering complete evaluation PCB

[2] Circuit Board Material: Rogers 4350

The circuit board used in the final application should use RF circuit design techniques. Signal lines should have 50 ohm impedance while the package ground leads and package base should be connected directly to the ground plane similar to that shown. A sufficient number of VIA holes should be used to connect the top and bottom ground planes. The evaluation circuit board shown is available from Hittite upon request.