



TV VIDEO IF SYSTEM

The functions incorporated are :

- GAIN CONTROLLED VISION IF AMPLIFIER
- SYNCHRONOUS DETECTOR
- AGC DETECTOR WITH GATING FACILITY
- AGC AMPLIFIER FOR PNP TUNER DRIVE WITH VARIABLE DELAY
- VIDEO PREAMPLIFIER WITH POSITIVE AND NEGATIVE OUTPUTS

DESCRIPTION

The TDA440S is a monolithic integrated circuit in a 16-lead dual in-line plastic package.

It is intended for use in black and white and colour TV receivers.

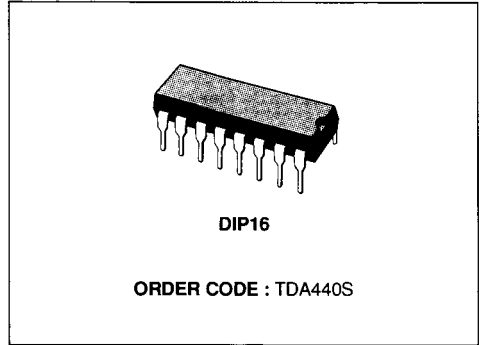

CONNECTION DIAGRAM (top view)

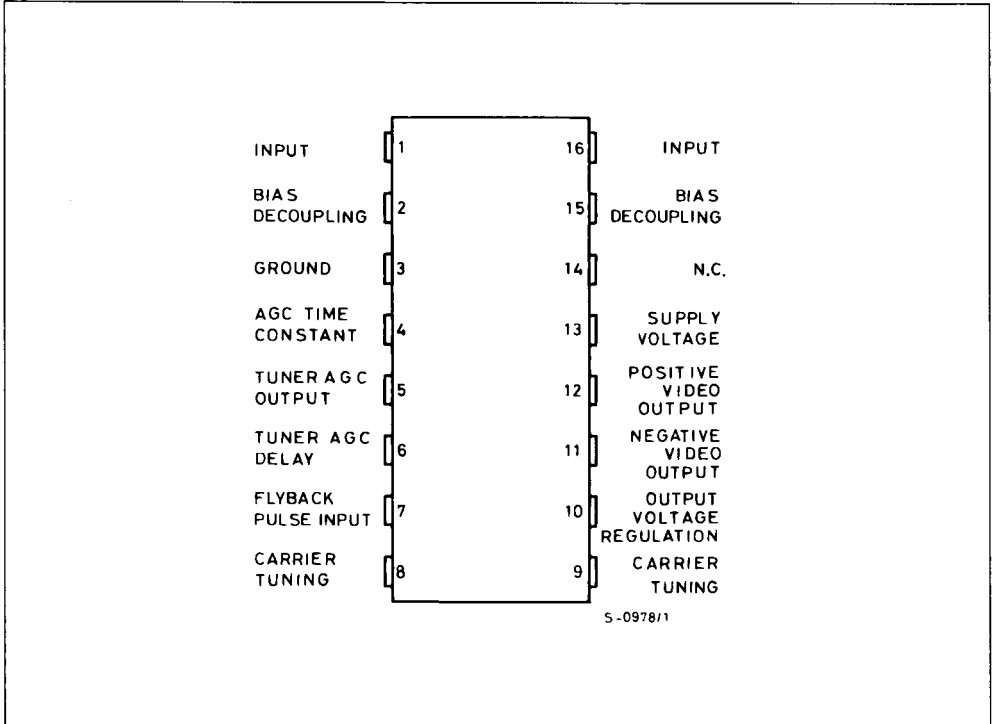

ABSOLUTE MAXIMUM RATINGS

Symbol	Parameter	Value	Unit
V_s	Supply Voltage (pin 13)	15	V
V_5	Voltage at Pin 5	- 1 to 15	V
V_{10}	Voltage at Pin 10	3	V
V_{11}	Voltage at Pin 11 (with load connected to V_s)	8	V
I_{11}, I_{12}	Output Current	5	mA
P_{tot}	Total Power Dissipation at $T_{amb} \leq 70^\circ\text{C}$	800	mW
T_{stg}	Storage Temperature	- 55 to 150	$^\circ\text{C}$
T_{op}	Operating Temperature	0 to 70	$^\circ\text{C}$

THERMAL DATA

$R_{th\ j-amb}$	Thermal Resistance Junction-ambient	Max	100	$^\circ\text{C}/\text{W}$
-----------------	-------------------------------------	-----	-----	---------------------------

ELECTRICAL CHARACTERISTICS ($T_{amb} = 25^\circ\text{C}$)

DC CHARACTERISTICS

Symbol	Parameter	Test Conditions	Min.	Typ.	Max.	Unit
V_s	Supply Voltage Range (pin 13)		10	12	15	V
I_s	Supply Current (pin 13)	$V_s = 12\text{ V}$		50		mA
$-I_{11}^{(1)}$	Output Current	$V_s = 15\text{ V}$ $V_{11} = 8\text{ V}$		1.6		mA
$V_{11}^{(2)}$	Output Voltage	$V_s = 12\text{ V}$ $R_s = \infty$			4.5	V
		$R_s = 0$	7			
$V_{12}^{(2)}$	Output Voltage	$V_s = 12\text{ V}$ $V_{11} = 5.5\text{ V}$		5.6		V
$\frac{\Delta V_{11}}{\Delta V_s}$	Output Voltage Drift	$V_s = 11\text{ to }14\text{ V}$		3.5		%

AC CHARACTERISTICS (refer to test circuit, $V_s = 12\text{ V}$, $T_{amb} = 25^\circ\text{C}$)

Symbol	Parameter	Test Conditions	Min.	Typ.	Max.	Unit
$I_5^{(3)}$	Turner AGC Current	$V_7 = 0$ $R_4 = 2.5\text{ K}\Omega$ $f_0 = 38.9\text{ MHz}$	6	9.5		mA
V_7	AGC Gating Pulse Input Peak Voltage	$f = 15.6\text{ KHz}$	- 1.5		- 5	V

ELECTRICAL CHARACTERISTICS (continued)

Symbol	Parameter	Test Conditions	Min.	Typ.	Max.	Unit
$V_i^{(4)}$	Input Sensitivity	$V_7 = 0$ $f_o = 38.9$ MHz $V_{11} = 3.3$ V Peak to Peak	100	150	220	μ V
ΔV_i	AGC Range	$V_7 = 0$ $\Delta V_o = 1$ dB $f_o = 38.9$ MHz $V_{11} = 3.3$ V Peak to Peak	50	60		dB
V_o	Peak to Peak Output Voltage at Pin 11	$V_7 = 0$ $V_{11} = -5.5$ V $f_o = 38.9$ MHz $V_i =$ See Note (5)	3.3	3.5	3.7	V
ΔV_o	Video Output Variation Over the AGC Range (0 to 5.5 MHz)	$V_7 = 0$ $\Delta V_i = 50$ dB $V_{11} = 3.3$ V Peak to Peak $f_o = 38.9$ MHz $f_m = 0$ to 5.5 MHz		1	2	dB
V_{11}, V_{12}	Sound IF a Video Output (5.5 MHz)	$V_7 = 0$ $V_i =$ See Note (5) f_o (vision) = 38.9 MHz f_o (sound) = 33.4 MHz	30			mV
	Differential Error of the Output Voltage (B & W)	$V_7 = 0$ $f_o = 38.9$ MHz $V_{11} = 3.3$ V Peak to Peak			15	%
V_{11}, V_{12}	Video Carrier and Video Carrier 2nd Harmonic Leakage at Video Outputs	$V_7 = 0$ $V_i =$ See Note (5) $f_o = 38.9$ MHz		15		mV
V_{11}, V_{12}	Video Carrier Leakage at Video Outputs	$V_7 = 0$ $V_i =$ See Note (5) $f_o = 38.9$ MHz		5		mV
B	Frequency Response (-3 dB)		8	10		MHz
d_{im}	Intermodulation Products at Video Outputs	$V_7 = 0$ $V_i =$ See Note (5) f_o (vision) = 38.9 MHz f_o (sound) = 33.4 MHz f_o (chroma) = 35.5 MHz		-50	-40	dB
R_i	Input Resistance (between pins 1 and 16)	$V_7 = 0$ $V_i =$ See Note (5)		1.4		K Ω
C_i	Input Capacitance (between pins 1 and 16)	$f_o = 38.9$ MHz		2		pF

- Notes :**
1. Current flowing out from pin 11 with the load connected to $V = 8$ V.
 2. V_{11} and V_{12} are adjustable simultaneously by means of the resistance, or by a variable voltage ≤ 0.6 V, connected between pin 10 and ground.
 3. Measured with an input voltage 10 dB higher than the V_i at which the tuner AGC current starts.
 4. RMS values of the unmodulated video carrier (modulation down).
 5. The input voltage V_i can have any value within the AGC range.

BLOCK DIAGRAM

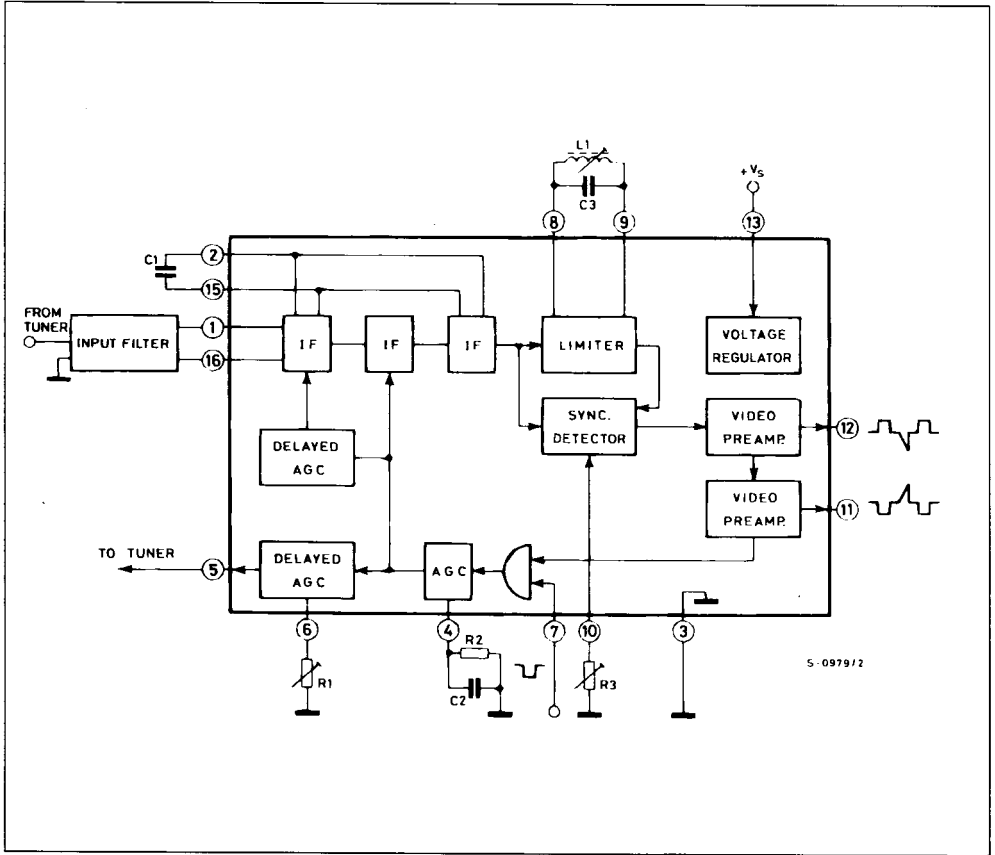
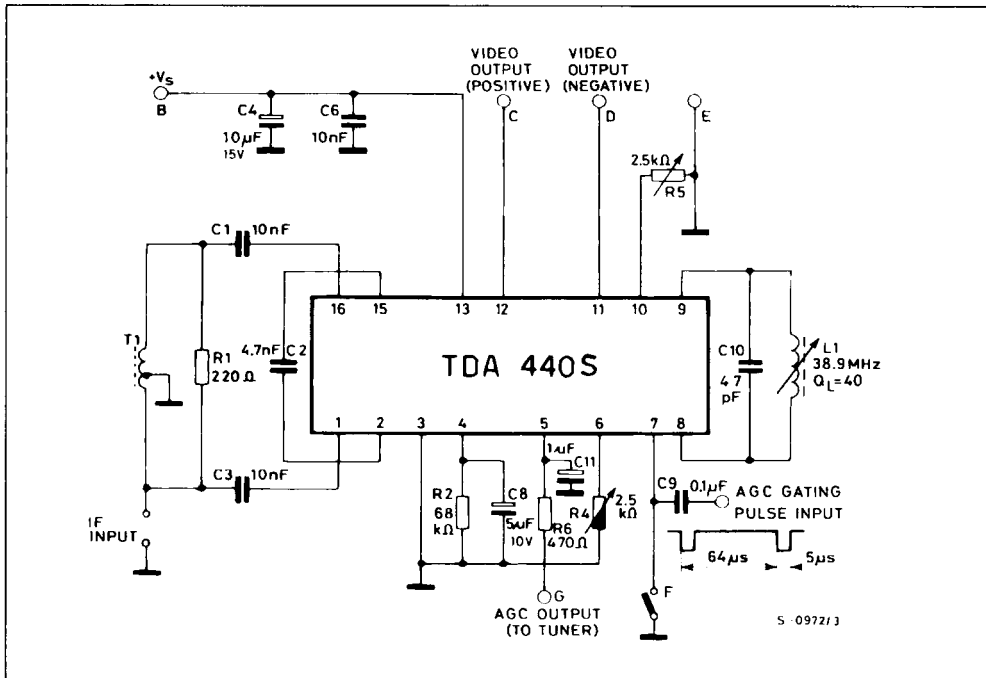

Figure 1 : AC Test Circuit.



Note : T1 = 50/200 W Balun transformer.
 Vi = Input voltage between pins 1 and 16.

Figure 2 : AGC Voltage vs. Input Voltage Variation.

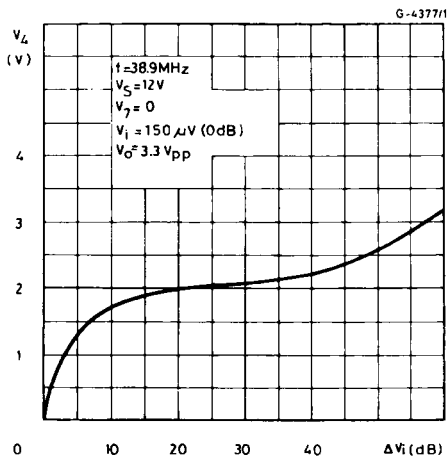

Figure 3 : Turner AGC Output Current vs. IF Gain Variation.

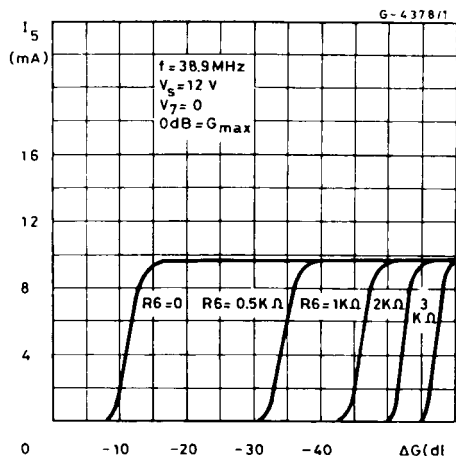
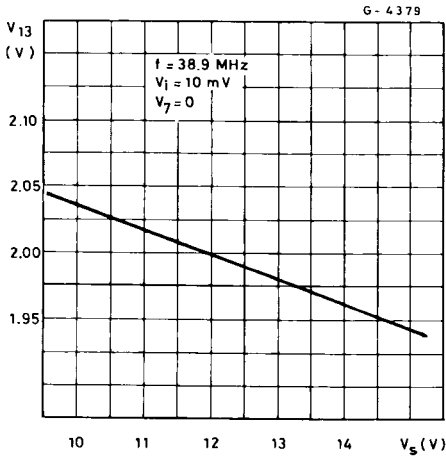

Figure 4 : Output Black Level vs. Supply Voltage.



APPLICATION INFORMATION

The TDA440S enables very compact IF amplifiers to be designed and provides the performance demanded by high quality receivers.

The input tuning-trapping circuitry and the detector network can be aligned independently with respect to each other.

The value of Q for the parallel tuned circuit between pin 8 and 9 is not critical, although the higher it is, the better is the chroma-sound beat rejection, but the tuning is more critical. Values of Q from 30 to 50 give good rejection with non-critical tuning.

The LC circuit between pins 8 and 9 is tuned to the vision carrier thus appreciably attenuating the side-

bands. Hence a small amount of signal can be removed whose amplitude is almost constant over the whole working range of the AGC and it can be used to drive an AFC circuit.

The black level at the output is very stable against variations of V_s and of temperature : this enables the contrast control to be kept simple. The AGC is of the gated type and can take the top of the synchronism or the black level (back porch) as its reference : when the latter is used, the output black level is particularly stable.

Figure 5 : Typical Application Circuit.

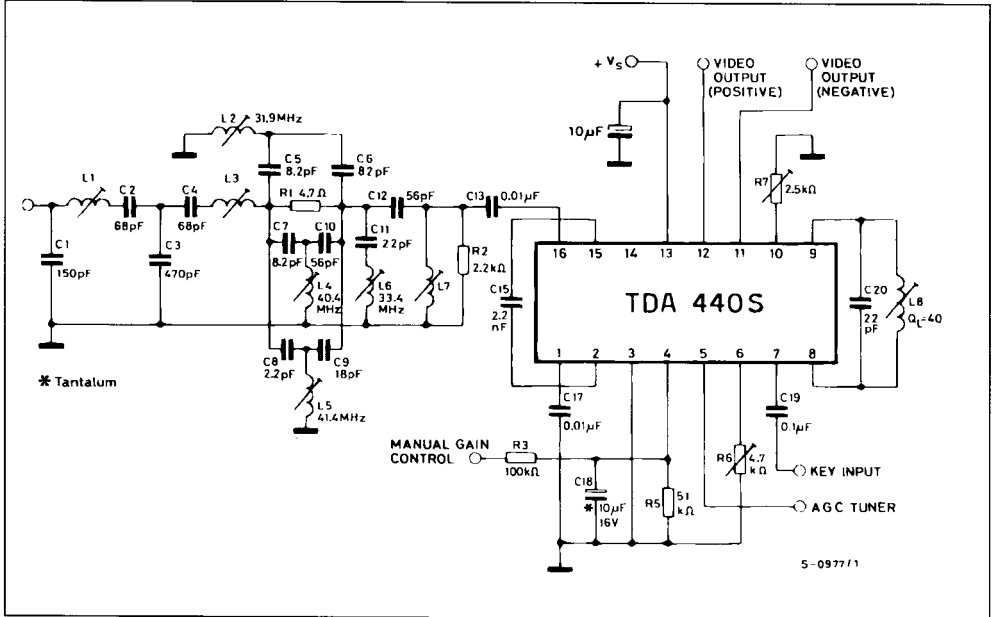

- L1 = 0.42 μH - Qo = 110 - 6 turns θ = 0.22 mm (close wound)
- L2, L3, L7 = 0.3 μH - Qo = 110 - 5.5 turns θ = 0.22 mm (close wound)
- L4 = 0.22 μH - Qo = 110 - 4.5 turns θ = 0.22 mm (close wound)
- L5, L6 = 1 μH - Qo = 110 - 10 turns θ = 0.22 mm (close wound)
- L8 = 1.2 μH - Qo = 110 - 10 turns θ = 0.22 mm (close wound)
- L1 to L7 : coil former BR27/P, core GW 4 x 0.5 x 13 F 100 Neosid, Screening can BR 10/ST.

Typical Performances of the Fig. 5 Circuit.

Frequency response (fo vision = 38.9 MHz, fo sound = 33.4 MHz) standard CCIR

Sound carrier attenuation	28	dB
31.9 MHz trap attenuation	≥ 60	dB
40.4 MHz trap attenuation	≥ 56	dB
41.4 MHz trap attenuation	≥ 44	dB
AGC range	55	dB
Overall gain including IF filter and trap circuits (note 1)	86	dB
Intermodulation products over the whole AGC range (note 2)	- 55	dB

- Notes :**
1. The gain is measured at video output 3.3V peak to peak and is defined as peak to peak output voltage to RMS input voltage (modulation down).
 2. Measured at 1.07 MHz, vision carrier level = 0 dB, chroma carrier level = - 6 dB, sound carrier level = - 6 dB.

Figure 6 : Overall Frequency Response of the Fig. 5 Circuit.

