

SANYO	No.5036A	2SC5231
		NPN Epitaxial Planar Silicon Transistor VHF to UHF Wide-Band Low-Noise Amp Applications

Features

- Low noise : $NF = 1.0\text{dB typ (} f = 1\text{GHz)}$.
- High gain : $|S_{21e}|^2 = 12\text{dB typ (} f = 1\text{GHz)}$.
- High cutoff frequency : $f_T = 7\text{GHz typ}$.
- Very small-sized package permitting 2SC5231-applied sets to be made small and slim.

Absolute Maximum Ratings at $T_a = 25^\circ\text{C}$

			unit
Collector-to-Base Voltage	V_{CB0}	20	V
Collector-to-Emitter Voltage	V_{CE0}	10	V
Emitter-to-Base Voltage	V_{EB0}	2	V
Collector Current	I_C	70	mA
Collector Dissipation	P_C	100	mW
Junction Temperature	T_j	150	$^\circ\text{C}$
Storage Temperature	T_{stg}	- 55 to + 150	$^\circ\text{C}$

Electrical Characteristics at $T_a = 25^\circ\text{C}$

			min	typ	max	unit
Collector Cutoff Current	I_{CB0}	$V_{CB} = 10\text{V}, I_E = 0$			1.0	μA
Emitter Cutoff Current	I_{EB0}	$V_{EB} = 1\text{V}, I_C = 0$			10	μA
DC Current Gain	h_{FE}	$V_{CE} = 5\text{V}, I_C = 20\text{mA}$	60*		270*	
Gain-Bandwidth Product	f_T	$V_{CE} = 5\text{V}, I_C = 20\text{mA}$	5	7		GHz
Output Capacitance	C_{ob}	$V_{CB} = 10\text{V}, f = 1\text{MHz}$		0.7	1.2	pF
Reverse Transfer Capacitance	C_{re}	$V_{CB} = 10\text{V}, f = 1\text{MHz}$		0.45		pF
Forward Transfer Gain	$ S_{21e} ^2(1)$	$V_{CE} = 5\text{V}, I_C = 20\text{mA}, f = 1\text{GHz}$	9	12		dB
	$ S_{21e} ^2(2)$	$V_{CE} = 2\text{V}, I_C = 3\text{mA}, f = 1\text{GHz}$		8.5		dB
Noise Figure	NF	$V_{CE} = 5\text{V}, I_C = 7\text{mA}, f = 1\text{GHz}$	1.0		1.8	dB

* : Pulse Test Pulse Width $\leq 2\text{ms}$

※ : The 2SC5231 is classified by 20mA h_{FE} as follows :

Marking	C7	C8	C9
h_{FE}	60 to 120	90 to 180	135 to 270

Package Dimensions 2106A
(unit: mm)

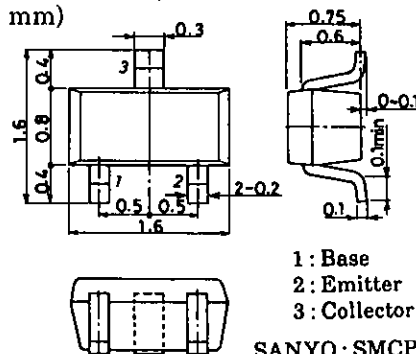

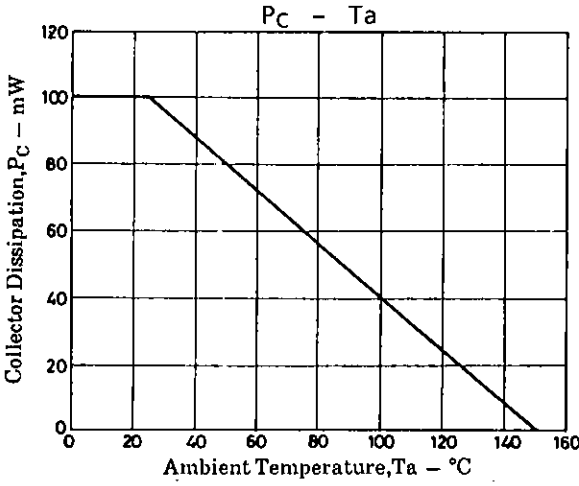
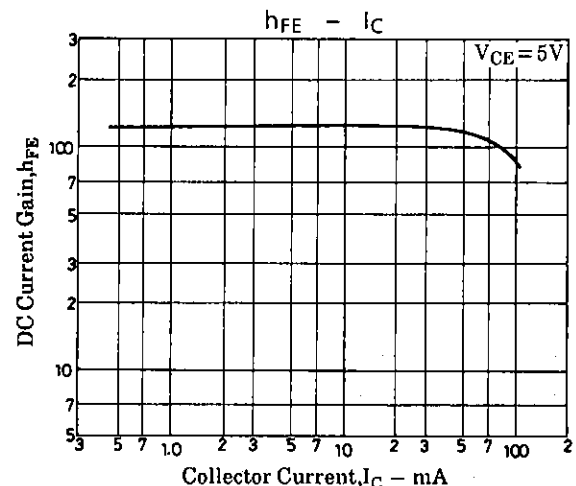
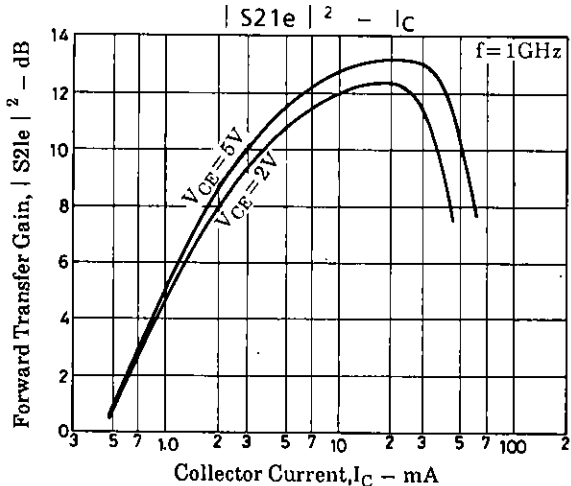
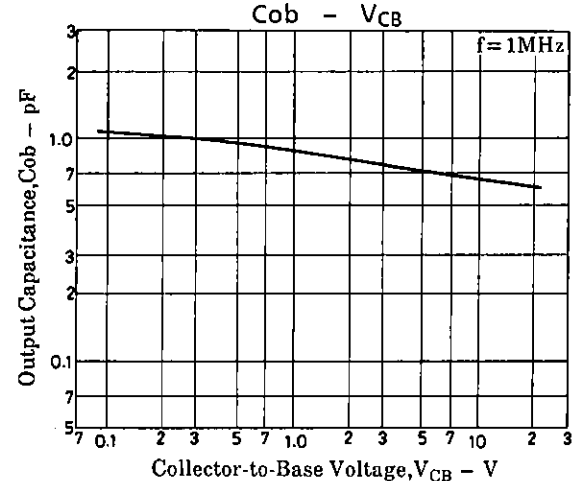
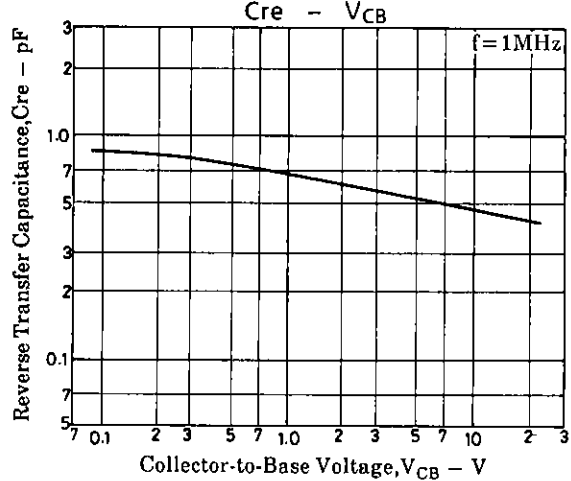
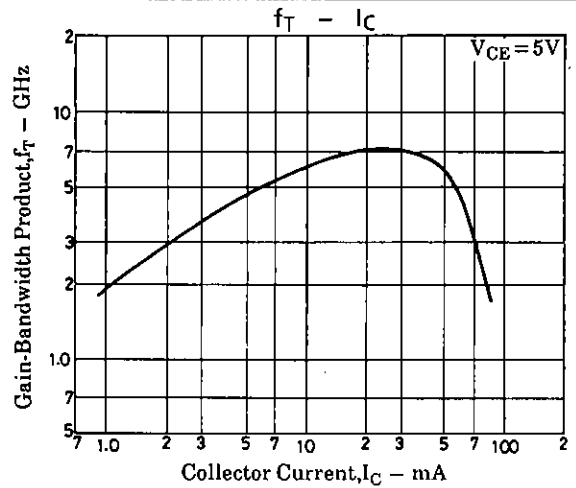
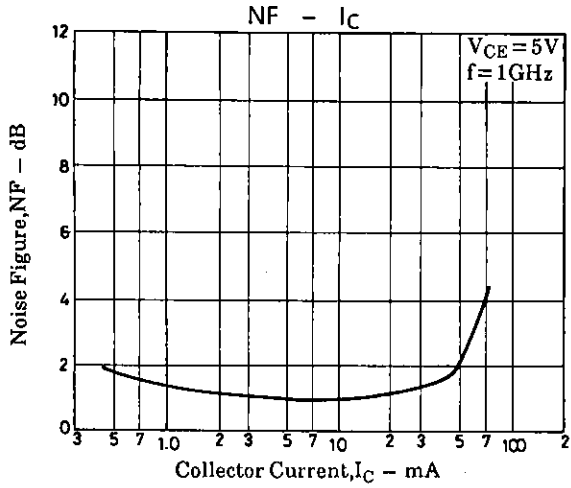

S Parameter

S11e : f=100MHz, 200~2000MHz (200MHz step)

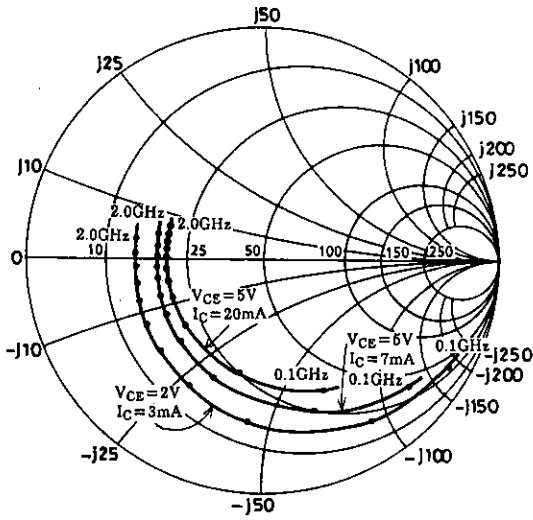

S21e : f=100MHz, 200~2000MHz (200MHz step)

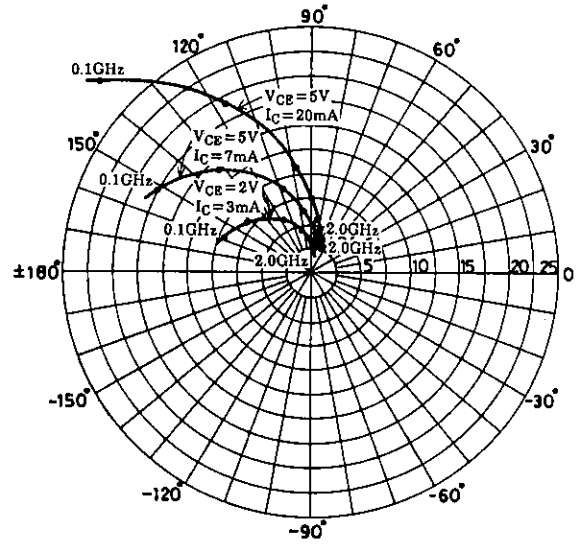

S12e : f=100MHz, 200~2000MHz (200MHz step)

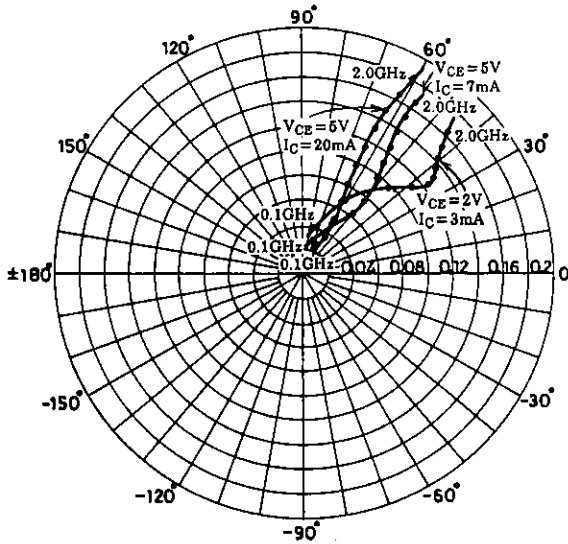

S22e : f=100MHz, 200~2000MHz (200MHz step)

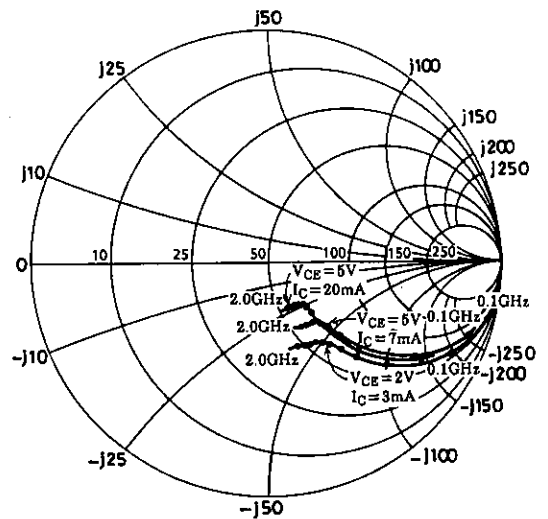

S Parameter (Common emitter)

 $V_{CE}=5V, I_C=7mA, Z_0=50\Omega$

Freq (MHz)	$ S_{11} $	$\angle S_{11}$	$ S_{21} $	$\angle S_{21}$	$ S_{12} $	$\angle S_{12}$	$ S_{22} $	$\angle S_{22}$
100	0.786	-40.7	17.507	151.3	0.028	70.1	0.898	-20.4
200	0.677	-72.4	13.998	131.4	0.046	58.0	0.739	-33.4
400	0.546	-112.7	9.061	108.6	0.064	49.6	0.525	-43.7
600	0.492	-135.2	6.442	96.1	0.076	49.3	0.423	-46.7
800	0.473	-150.0	5.005	87.3	0.087	50.8	0.374	-44.4
1000	0.465	-160.0	4.073	80.4	0.099	52.6	0.346	-49.7
1200	0.457	-169.5	3.449	74.0	0.111	54.0	0.332	-51.6
1400	0.451	-176.2	2.989	68.6	0.124	55.2	0.321	-54.1
1600	0.449	177.8	2.658	63.8	0.138	56.6	0.319	-56.2
1800	0.454	172.5	2.378	58.4	0.151	56.7	0.313	-60.0
2000	0.460	167.1	2.154	54.0	0.166	56.7	0.311	-63.2

 $V_{CE}=5V, I_C=20mA, Z_0=50\Omega$

Freq (MHz)	$ S_{11} $	$\angle S_{11}$	$ S_{21} $	$\angle S_{21}$	$ S_{12} $	$\angle S_{12}$	$ S_{22} $	$\angle S_{22}$
100	0.601	-65.8	28.967	137.1	0.023	64.1	0.757	-32.9
200	0.497	-103.7	19.309	116.6	0.035	57.0	0.534	-50.3
400	0.435	-139.6	10.891	98.6	0.050	58.7	0.345	-50.3
600	0.419	-156.6	7.461	89.3	0.065	61.3	0.280	-50.7
800	0.414	-166.6	5.695	82.5	0.081	63.1	0.251	-51.3
1000	0.413	-174.0	4.613	77.0	0.098	63.8	0.235	-52.9
1200	0.413	178.6	3.870	71.8	0.114	63.9	0.226	-55.1
1400	0.411	173.8	3.345	66.9	0.131	63.6	0.221	-57.7
1600	0.413	169.6	2.960	62.7	0.148	63.2	0.220	-60.2
1800	0.416	165.1	2.655	58.0	0.165	61.8	0.219	-64.8
2000	0.422	160.3	2.406	54.0	0.182	60.6	0.218	-68.3

 $V_{CE}=2V, I_C=3mA, Z_0=50\Omega$

Freq (MHz)	$ S_{11} $	$\angle S_{11}$	$ S_{21} $	$\angle S_{21}$	$ S_{12} $	$\angle S_{12}$	$ S_{22} $	$\angle S_{22}$
100	0.888	-30.2	9.280	158.6	0.038	73.6	0.949	-15.1
200	0.815	-56.4	8.218	141.3	0.067	60.5	0.849	-26.9
400	0.690	-96.0	6.074	116.7	0.098	45.1	0.657	-41.1
600	0.616	-120.7	4.517	101.4	0.112	38.4	0.539	-47.6
800	0.584	-138.0	3.610	90.4	0.120	35.8	0.475	-51.2
1000	0.566	-150.7	2.995	81.9	0.125	35.7	0.434	-54.5
1200	0.555	-161.2	2.540	74.2	0.131	36.5	0.410	-57.5
1400	0.546	-169.3	2.213	67.5	0.137	38.4	0.393	-60.7
1600	0.541	-176.4	1.982	62.0	0.143	40.7	0.391	-64.0
1800	0.545	177.1	1.774	55.9	0.152	42.5	0.382	-67.8
2000	0.547	170.9	1.614	50.9	0.163	44.7	0.381	-72.1

- No products described or contained herein are intended for use in surgical implants, life-support systems, aerospace equipment, nuclear power control systems, vehicles, disaster/crime-prevention equipment and the like, the failure of which may directly or indirectly cause injury, death or property loss.
- Anyone purchasing any products described or contained herein for an above-mentioned use shall:
 - ① Accept full responsibility and indemnify and defend SANYO ELECTRIC CO., LTD., its affiliates, subsidiaries and distributors and all their officers and employees, jointly and severally, against any and all claims and litigation and all damages, cost and expenses associated with such use:
 - ② Not impose any responsibility for any fault or negligence which may be cited in any such claim or litigation on SANYO ELECTRIC CO., LTD., its affiliates, subsidiaries and distributors or any of their officers and employees jointly or severally.
- Information (including circuit diagrams and circuit parameters) herein is for example only; it is not guaranteed for volume production. SANYO believes information herein is accurate and reliable, but no guarantees are made or implied regarding its use or any infringements of intellectual property rights or other rights of third parties.

This catalog provides information as of **February**, 1996. Specifications and information herein are subject to change without notice.