

**SANYO****DC-DC Converter Applications****Features**

- Low ON resistance.
- 4V drive.

**Package Dimensions**

unit:mm

2129

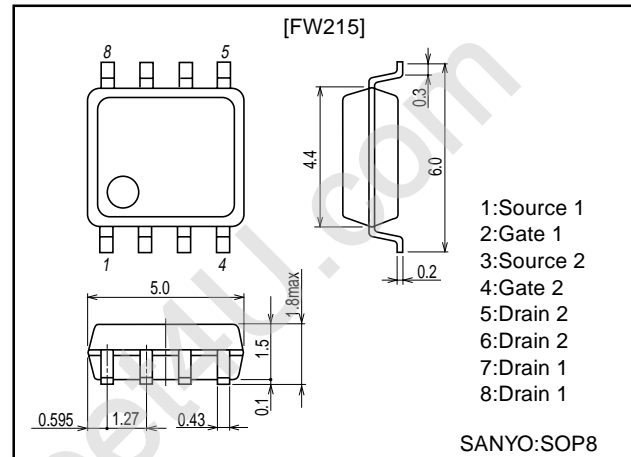
**Specifications****Absolute Maximum Ratings** at Ta = 25°C

Parameter	Symbol	Conditions	Ratings	Unit
Drain-to-Source Voltage	$V_{DSS}$		30	V
Gate-to-Source Voltage	$V_{GSS}$		$\pm 20$	V
Drain Current (DC)	$I_D$		5	A
Drain Current (pulse)	$I_{DP}$	$PW \leq 10\mu s$ , duty cycle $\leq 1\%$	48	A
Allowable Power Dissipation	$P_D$	Mounted on a ceramic board (1200mm <sup>2</sup> ×0.8mm) 1unit	1.7	W
Total Dissipation	$P_T$	Mounted on a ceramic board (1200mm <sup>2</sup> ×0.8mm)	2.0	W
Channel Temperature	$T_{ch}$		150	°C
Storage Temperature	$T_{stg}$		-55 to +150	°C

**Electrical Characteristics** at Ta=25°C

Parameter	Symbol	Conditions	Ratings			Unit
			min	typ	max	
Drain-to-Source Breakdown Voltage	$V_{(BR)DSS}$	$I_D=1mA$ , $V_{GS}=0$	30			V
Zero Gate Voltage Drain Current	$I_{DSS}$	$V_{DS}=30V$ , $V_{GS}=0$			100	$\mu A$
Gate-to-Source Leakage Current	$I_{GSS}$	$V_{GS}=\pm 16V$ , $V_{DS}=0$			$\pm 10$	$\mu A$
Cutoff Voltage	$V_{GS(off)}$	$V_{DS}=10V$ , $I_D=1mA$	1.0		2.4	V
Forward Transfer Admittance	$ y_{fs} $	$V_{DS}=10V$ , $I_D=5A$	5		9	S
Static Drain-to-Source ON-State Resistance	$R_{DS(on)1}$	$I_D=5A$ , $V_{GS}=10V$		36	46	m $\Omega$
	$R_{DS(on)2}$	$I_D=5A$ , $V_{GS}=4V$		58	78	m $\Omega$
Input Capacitance	$C_{iss}$	$V_{DS}=10V$ , $f=1MHz$		460		pF
Output Capacitance	$C_{oss}$	$V_{DS}=10V$ , $f=1MHz$		250		pF
Reverse Transfer Capacitance	$C_{rss}$	$V_{DS}=10V$ , $f=1MHz$		120		pF
Turn-ON Delay Time	$t_{d(on)}$	See Specified Test Circuit		10		ns
Rise Time	$t_r$	See Specified Test Circuit		120		ns
Turn-OFF Delay Time	$t_{d(off)}$	See Specified Test Circuit		70		ns
Fall Time	$t_f$	See Specified Test Circuit		80		ns
Total Gate Charge	$Q_g$	$V_{DS}=10V$ , $V_{GS}=10V$ , $I_D=5A$		15		nC
Gate-to-Source Charge	$Q_{gs}$			3		nC
Gate-to-Drain "Miller" Charge	$Q_{gd}$			4		nC
Diode Forward Voltage	$V_{SD}$		$I_S=5A$ , $V_{GS}=0$	1.0	1.2	

Switching Time Test Circuit

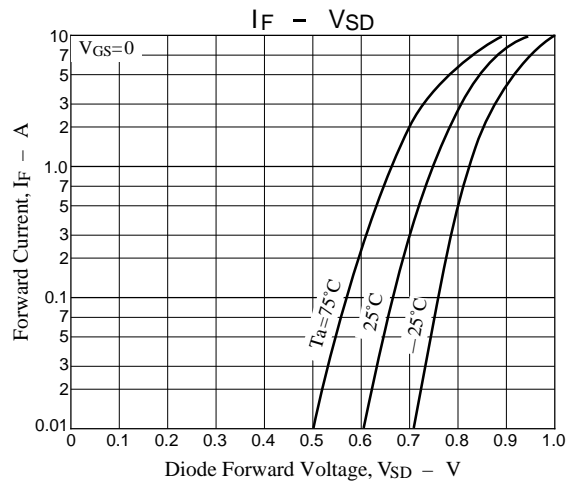
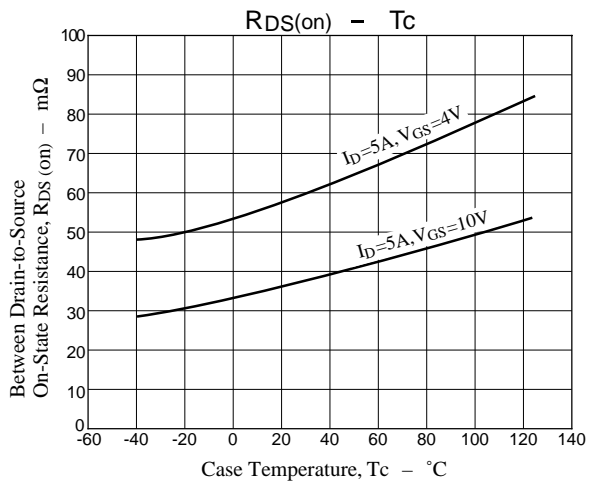
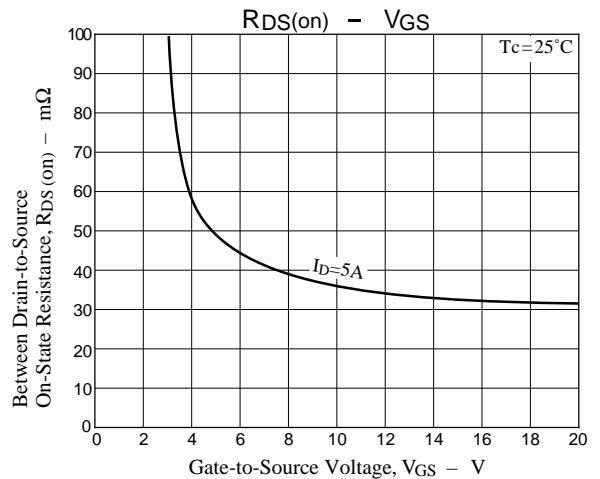
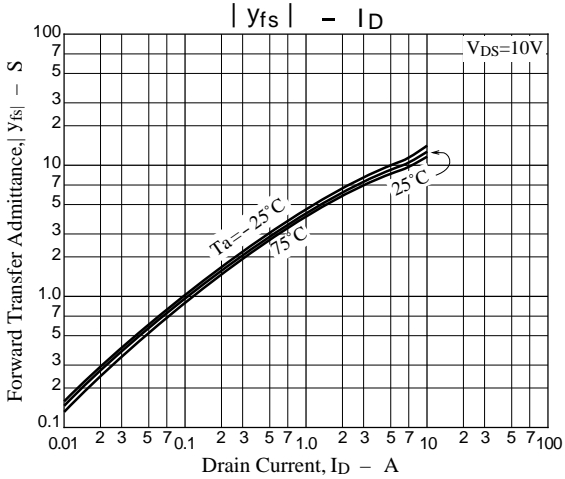
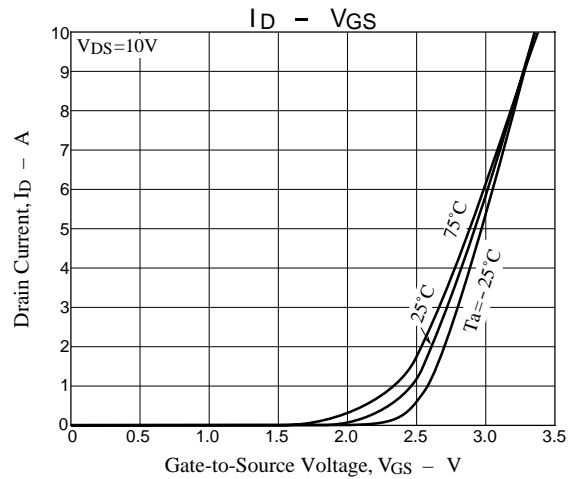
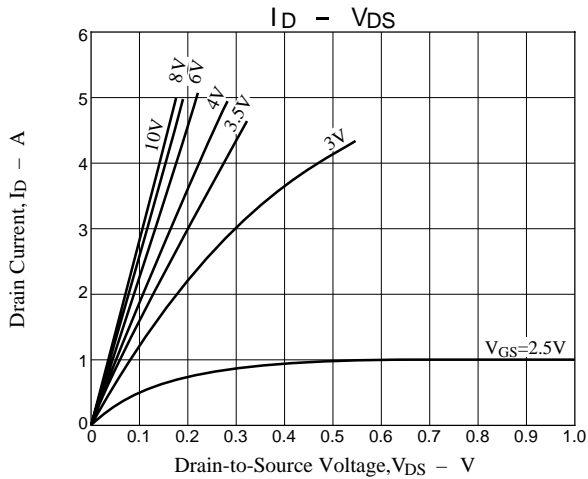
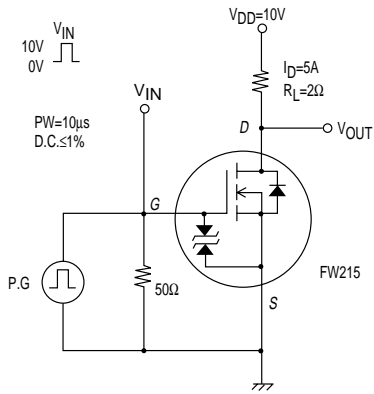

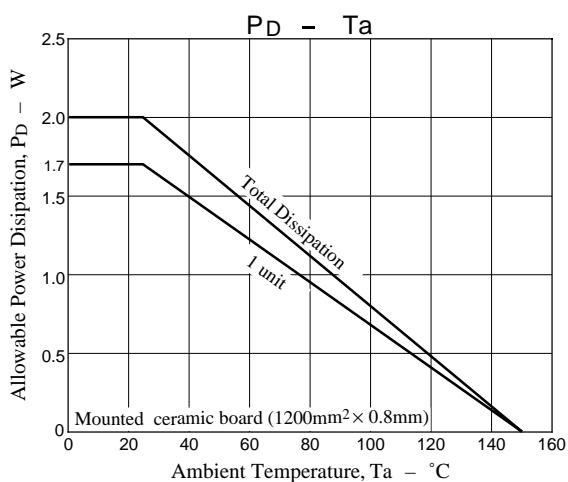
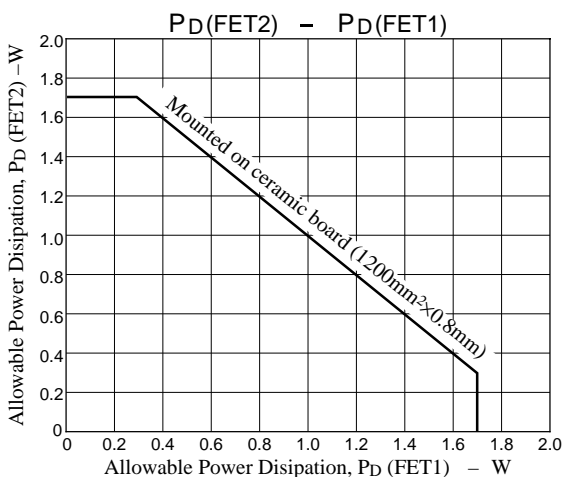
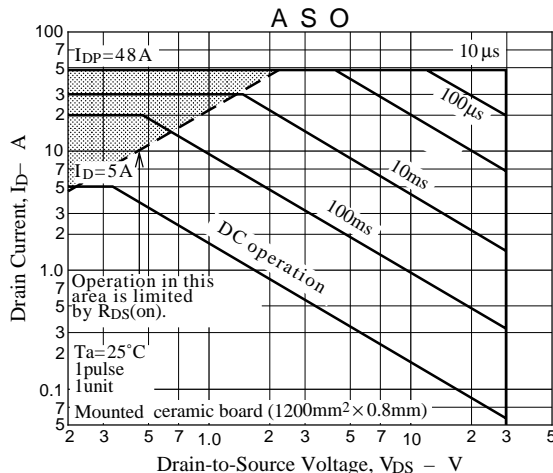
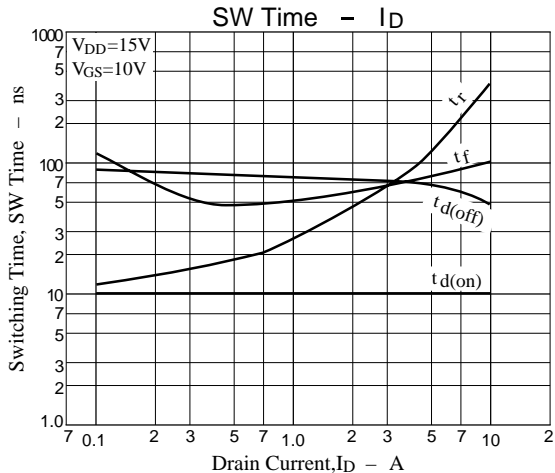
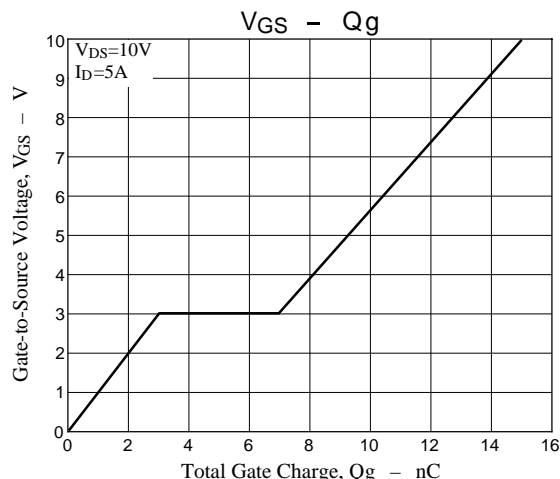
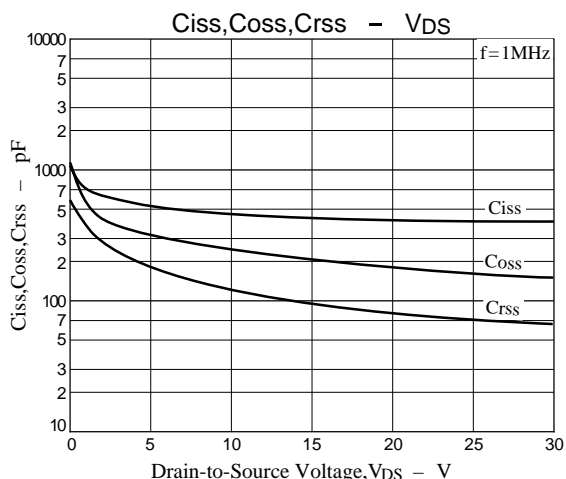

■ No products described or contained herein are intended for use in surgical implants, life-support systems, aerospace equipment, nuclear power control systems, vehicles, disaster/crime-prevention equipment and the like, the failure of which may directly or indirectly cause injury, death or property loss.

■ Anyone purchasing any products described or contained herein for an above-mentioned use shall:

- ① Accept full responsibility and indemnify and defend SANYO ELECTRIC CO., LTD., its affiliates, subsidiaries and distributors and all their officers and employees, jointly and severally, against any and all claims and litigation and all damages, cost and expenses associated with such use:
- ② Not impose any responsibility for any fault or negligence which may be cited in any such claim or litigation on SANYO ELECTRIC CO., LTD., its affiliates, subsidiaries and distributors or any of their officers and employees jointly or severally.

■ Information (including circuit diagrams and circuit parameters) herein is for example only; it is not guaranteed for volume production. SANYO believes information herein is accurate and reliable, but no guarantees are made or implied regarding its use or any infringements of intellectual property rights or other rights of third parties.

This catalog provides information as of June, 1998. Specifications and information herein are subject to change without notice.