

SOTINY™ Low Resistance, Low-Voltage
Single-Supply SPDT Switch

Features

- Low On-Resistance: 10 ohms max.
- R_{ON} Matching: 2 ohms max.
- R_{ON} Flatness: 3.5 ohms max.
- Low 0.5nA Input Leakage at 25 °C
- 2V to 6V Single-Supply Operation
- Fast Switching Time
 - 15ns t_{ON}
 - 7ns t_{OFF}
- Break-Before-Make Switching Guaranteed
- 5pC max Charge Injection
- 225MHz Channel Bandwidth
- 76dB Off-Isolation at 1MHz
- TTL/CMOS Logic Compatible
- Low Power Consumption: 5 μ W
- Improved Direct Replacement for MAX4599
- Packages available:
 - 6-pin Small Compact SC70

Applications

- Communication Circuits
- Cellular Phones
- Audio and Video Signal Routing
- Portable Battery-Operated Equipment
- Data Acquisition Systems
- Computer Peripherals
- Telecommunications
- Relay Replacement
- Wireless Terminals and Peripherals

Description

The PI5A4599A is an improved, direct replacement for the MAX4599 single-pole, double-throw (SPDT) analog switch. Improved specifications include a low maximum ON resistance of 10 ohms and fast switching times ($t_{ON} = 15\text{ns max.}$, $t_{OFF} = 7\text{ns max.}$) with 5V supply operation. With a 2.5V supply, resistance is a low 40 ohms max.

Specifications are given for 2.5V, 3.3V and 5V power supply operation. Operating voltage range is 2.0V to 6.0V.

To minimize PC board area use, the PI5A4599A is available in a compact 6-pin SC70 package. Operating temperature range is -40°C to 85°C.

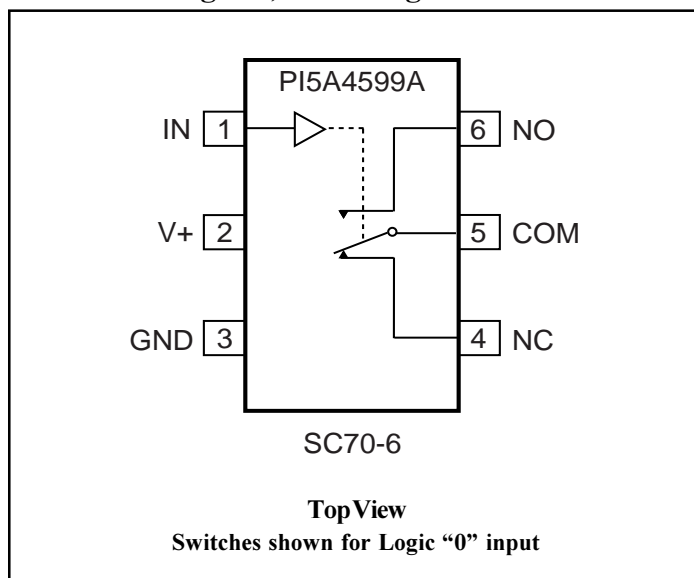
Functional Diagram, Pin Configuration

Truth Tables

Logic	PI5A4599A	
	NC	NO
0	ON	OFF
1	OFF	ON



Absolute Maximum Ratings

Voltages Referenced to GND
 V+ -0.5V to +7V
 V_{IN}, V_{COM}, V_{NC}, V_{NO} (Note 1) -0.5V to V_{CC}+2V
 or 30mA, whichever occurs first
 Current (any terminal) ±30mA
 Peak Current, COM, NO, NC
 (Pulsed at 1ms, 10% duty cycle) ±30mA

Thermal Information

Continuous Power Dissipation
 SC70-6 (derate 3.1mW/°C above +70°C) 245mW
 Storage Temperature -65°C to +150°C
 Lead Temperature (soldering, 10s) +300°C

Note:

1. Signals on NC, NO, COM, or IN exceeding V+ or Gnd are clamped by internal diodes. Limit forward diode current to 30mA.

Caution: Stresses beyond those listed under “Absolute Maximum Ratings” may cause permanent damage to the device. This is a stress only rating and operation of the device at these or any other conditions beyond those indicated in the operational sections of this specification is not implied.

Electrical Specifications - Single +5V Supply

(V+ = +5V ± 10%, GND = 0V, V_{INH} = 2.4V, V_{INL} = 0.8V)

Parameter	Symbol	Conditions	Temp.(°C)	Min. ⁽¹⁾	Typ. ⁽²⁾	Max. ⁽¹⁾	Units
Analog Switch							
Analog Signal Range ⁽³⁾	V _{ANALOG}		Full	0		V+	V
On Resistance	R _{ON}	V+ = 4.5V, I _{COM} = -30mA, V _{NO} or V _{NC} = +2.5V	25		7	8	ohm
On-Resistance Match Between Channels ⁽⁴⁾	ΔR _{ON}		Full			10	
On-Resistance Flatness ⁽⁵⁾	R _{FLAT(ON)}	V+ = 5V, I _{COM} = -30mA, V _{NO} or V _{NC} = 1V, 2.5V, 4V	25		0.1	0.5	
			Full			1	
NO or NC Off Leakage Current ⁽⁶⁾	I _{NO(OFF)} or I _{NC(OFF)}	V+ = 5.5V, V _{COM} = 0V, V _{NO} or V _{NC} = 4.5V	25	-0.5	0.18	0.5	nA
			Full			5	
COM Off Leakage Current ⁽⁶⁾	I _{COM(OFF)}	V+ = 5.5V, V _{COM} = + 4.5V, V _{NO} or V _{NC} = ± 0V	25	-1.0	0.20	1.0	
			Full			10	
COM On Leakage Current ⁽⁶⁾	I _{COM(ON)}	V+ = 5.5V, V _{COM} = +4.5V V _{NO} or V _{NC} = +4.5V	25	-1.0	0.20	1.0	
			Full			10	

Electrical Specifications - Single +5V Supply (continued)

(V+ = +5V ± 10%, GND = 0V, V_{INH} = 2.4V, V_{INL} = 0.8V)

Parameter	Symbol	Conditions	Temp(°C)	Min. ⁽¹⁾	Typ. ⁽²⁾	Max. ⁽¹⁾	Units	
Logic Input								
Input High Voltage	V _{IH}	Guaranteed logic High Level	Full	2			V	
Input Low Voltage	V _{IL}	Guaranteed logic Low Level				0.8		
Input Current with Voltage High	I _{INH}	V _{IN} = 2.4V, all others = 0.8V		-1	0.005	1	μA	
Input Current with Voltage Low	I _{INL}	V _{IN} = 0.8V, all others = 2.4V		-1	0.005	1		
Dynamic								
Turn-On Time	t _{ON}	V _{CC} = 5V, Figure 1	25		7	15	ns	
			Full			20		
Turn-Off Time	t _{OFF}		25		1	7		
			Full			10		
Break-Before-Make	t _{BBM}	Figure 3	25			10		
			Full	5				
Charge Injection ⁽³⁾	Q		C _L = 1nF, V _{GEN} = 0V, R _{GEN} = 0 ohm, Figure 2	25		1.5	5	pC
Off Isolation	OIRR		R _L = 50 ohms, C _L = 5pF, f = 1MHz, Figure 4			80		dB
Crosstalk ⁽⁸⁾	X _{TALK}	R _L = 50 ohms, C _L = 5pF, f = 1MHz, Figure 5			80			
NC or NO Capacitance	C _(OFF)	f = 1MHz, Figure 6			5.0		pF	
COM Off Capacitance	C _{COM(OFF)}				5.0			
COM On Capacitance	C _{COM(ON)}		f = 1MHz, Figure 7			13		
-3dB Bandwidth	BW	R _L = 50 ohms, Figure 8	Full		300		MHz	
Supply								
Power-Supply Range	V+		Full	2		6	V	
Positive Supply Current	I+	V _{CC} = 5.5V, V _{IN} = 0V or V+				1	μA	

Notes:

1. The algebraic convention, where most negative value is a minimum and most positive is a maximum, is used in this data sheet.
2. Typical values are for DESIGN AID ONLY, not guaranteed or subject to production testing.
3. Guaranteed by design.
4. ΔR_{ON} = R_{ON} max. - R_{ON} min.
5. Flatness is defined as the difference between the maximum and minimum value of On-resistance measured.
6. Leakage parameters are 100% tested at maximum rated hot temperature and guaranteed by correlation at +25°C.
7. Off Isolation = 20log₁₀ [V_{COM} / (V_{NO} or V_{NC})]. See Figure 3.
8. Between any two switches. See Figure 4.

Electrical Specifications - Single +3.3V Supply

(V+ = +3.3V ± 10%, GND = 0V, V_{INH} = 2.4V, V_{INL} = 0.8V)

Parameter	Symbol	Conditions	Temp.(°C)	Min. ⁽¹⁾	Typ. ⁽²⁾	Max. ⁽¹⁾	Units
Analog Switch							
Analog Signal Range ⁽³⁾	V _{ANALOG}			0		V+	V
On-Resistance	R _{ON}	V+ = 3V, I _{COM} = -30mA, V _{NO} or V _{NC} = 1.5V	25		12	14.0	Ω
			Full			17	
On-Resistance Match Between Channels ⁽⁴⁾		V+ = 3.3V, I _{COM} = -30mA, V _{NO} or V _{NC} = 0.8V, 2.5V	25		0.2	0.5	
			Full			1	
On-Resistance Flatness ^(3,5)	R _{FLAT(ON)}	V+ = 3.3V, I _{COM} = -30mA, V _{NO} or V _{NC} = 0.8V, 2.5V	25		0.5	4	
			Full			5	
Dynamic							
Turn-On Time	t _{ON}	V+ = 3.3V, V _{NO} or V _{NC} = 1.5V, Figure 1	25		15	25	ns
			Full			40	
Turn-Off Time	t _{OFF}	V+ = 3.3V, V _{NO} or V _{NC} = 1.5V, Figure 1	25		1.5	12	
			Full			20	
Break-Before-Make	t _{BBM}	Figure 3	25		10		
			Full	5			
Charge Injection ⁽³⁾	Q	C _L = 1nF, V _{GEN} = 0V, R _{GEN} = 0V, Figure 2	25		1.3	5	pC
Supply							
Positive Supply Current	I+	V+ = 3.6V, V _{IN} = 0V or V+ All Channels on or off	Full			1	μA
Logic Input							
Input High Voltage	V _{IH}	Guaranteed logic high level	Full	2			V
Input Low Voltage	V _{IL}	Guaranteed logic low level	Full			0.8	
Input High Current	I _{INH}	V _{IN} = 2.4V, all others = 0.8V	Full	-1		1	μA
Input Low Current	I _{INL}	V _{IN} = 0.8V, all others = 2.4V	Full	-1		1	

Notes:

1. The algebraic convention, where most negative value is a minimum and most positive is a maximum, is used in this data sheet.
2. Typical values are for DESIGN AID ONLY, not guaranteed or subject to production testing.
3. Guaranteed by design.
4. ΔR_{ON} = R_{ON} max. - R_{ON} min.
5. Flatness is defined as the difference between the maximum and minimum value of On-resistance measured.
6. Leakage parameters are 100% tested at maximum rated hot temperature and guaranteed by correlation at +25°C.
7. Off Isolation = 20log₁₀ [V_{COM} / (V_{NO} or V_{NC})]. See Figure 4.
8. Between any two switches. See Figure 5.

Electrical Specifications - Single +2.5V Supply

(V+ = +2.5V ± 10%, GND = 0V, V_{INH} = 2.4V, V_{INL} = 0.8V)

Parameter	Symbol	Conditions	Temp.(°C)	Min. ⁽¹⁾	Typ. ⁽²⁾	Max. ⁽¹⁾	Units
Analog Switch							
Analog Signal Range ⁽³⁾	V _{ANALOG}			0		V+	V
On-Resistance	R _{ON}	V+ = 2.5V, I _{COM} = -30mA, V _{NO} or V _{NC} = 1.5V	25		20	22	Ω
			Full			26	
On-Resistance Match Between Channels ⁽⁴⁾	ΔR _{ON}	V+ = 2.5V, I _{COM} = -30mA, V _{NO} or V _{NC} = 0.8V, 2.5V	25		0.3	0.5	
			Full			1	
On-Resistance Flatness ^(3,5)	R _{FLAT(ON)}	V+ = 2.5V, I _{COM} = -30mA, V _{NO} or V _{NC} = 0.8V, 2.5V	25		0.5	5	
			Full			6	
Dynamic							
Turn-On Time	t _{ON}	V+ = 2.5V, V _{NO} or V _{NC} = 1.5V, Figure 1	25		20	30	ns
			Full		-	45	
Turn-Off Time	t _{OFF}	V+ = 2.5V, V _{NO} or V _{NC} = 1.5V, Figure 1	25			20	
			Full		-	30	
Break-Before-Make	t _{BBM}	Figure 3	25		10		
			Full	5			
Charge Injection ⁽³⁾	Q	C _L = 1nF, V _{GEN} = 0V, R _{GEN} = 0V, Figure 2	25		0.9	5	pC
Supply							
Positive Supply Current	I+	V+ = 2.5V, V _{IN} = 0V or V+ All Channels on or off	Full			1	μA
Logic Input							
Input High Voltage	V _{IH}	Guaranteed logic high level	Full	2			V
Input Low Voltage	V _{IL}	Guaranteed logic low level	Full			0.8	
Input High Current	I _{INH}	V _{IN} = 2.4V, all others = 0.8V	Full	-1		1	μA
Input Low Current	I _{INL}	V _{IN} = 0.8V, all others = 2.4V	Full	-1		1	

Notes:

1. The algebraic convention, where most negative value is a minimum and most positive is a maximum, is used in this data sheet.
2. Typical values are for DESIGN AID ONLY, not guaranteed or subject to production testing.
3. Guaranteed by design.
4. ΔR_{ON} = R_{ON} max. - R_{ON} min.
5. Flatness is defined as the difference between the maximum and minimum value of On-resistance measured.
6. Leakage parameters are 100% tested at maximum rated hot temperature and guaranteed by correlation at +25°C.
7. Off Isolation = 20log₁₀ [V_{COM} / (V_{NO} or V_{NC})]. See Figure 4.
8. Between any two switches. See Figure 5.

Test Circuits/Timing Diagrams

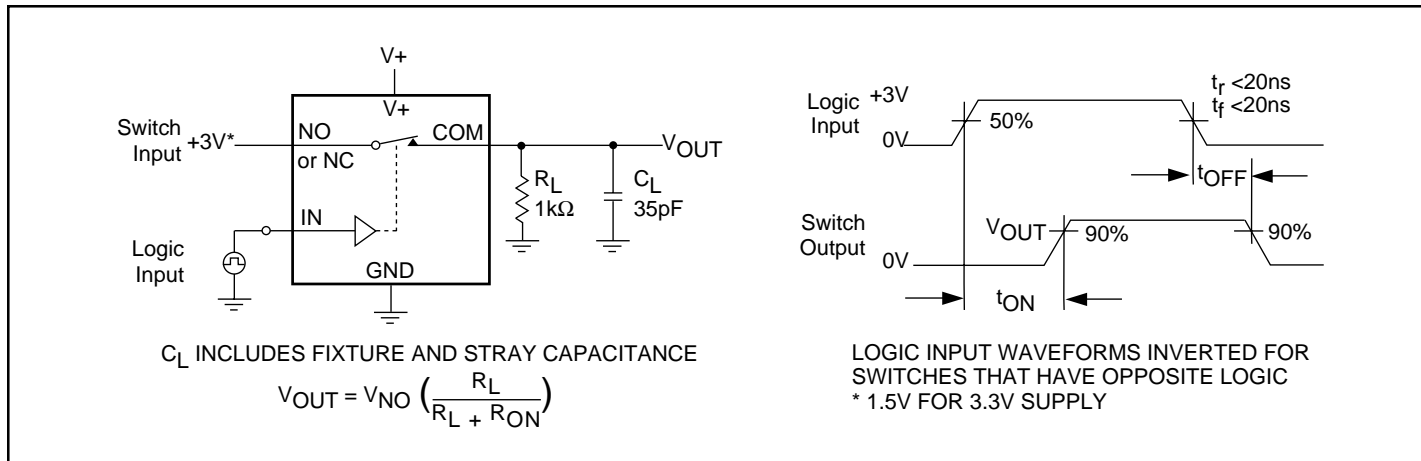

Figure 1. Switching Time

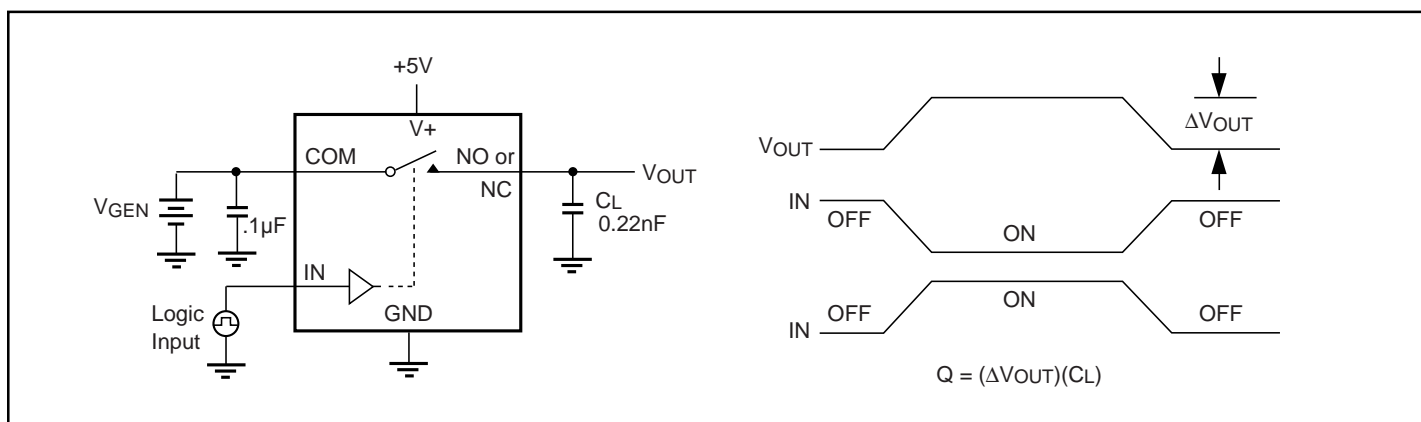

Figure 2. Charge Injection

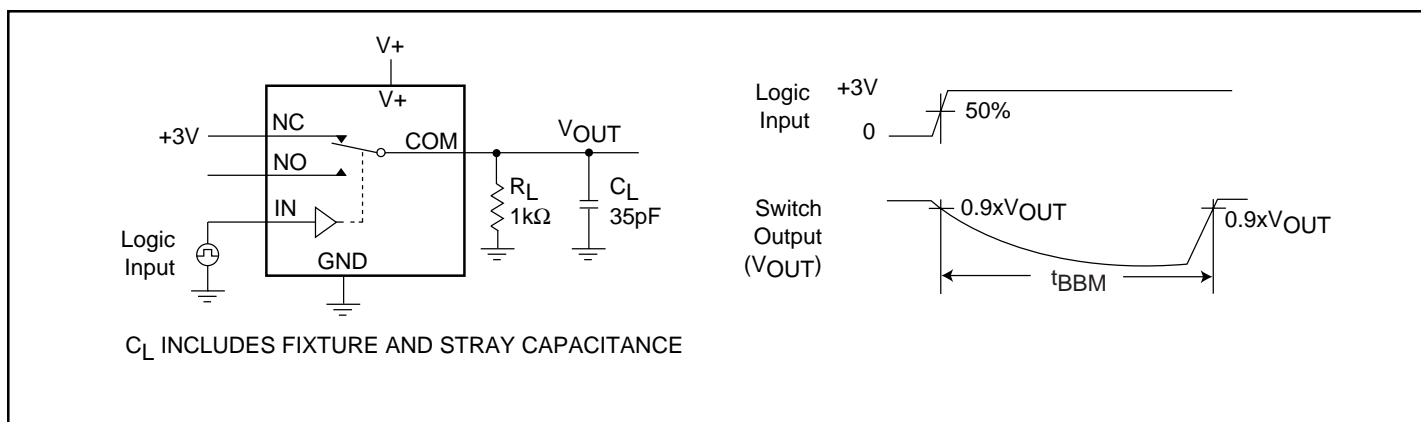

Figure 3. Break-Before-Make Interval

Test Circuits/Timing Diagrams (continued)

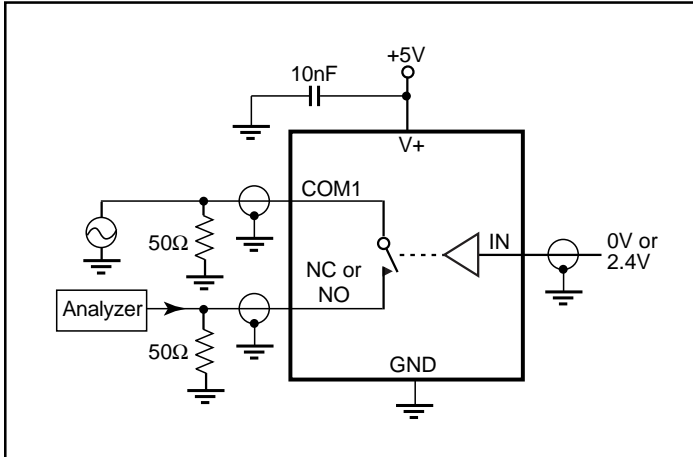

Figure 4. Off Isolation/On-Channel Bandwidth

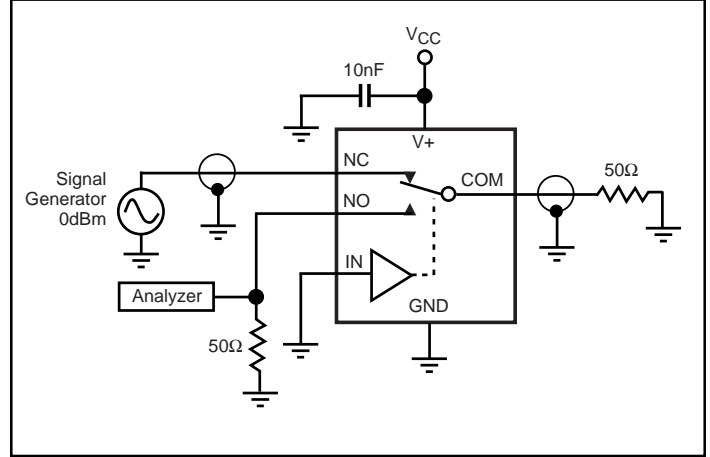

Figure 5. Crosstalk

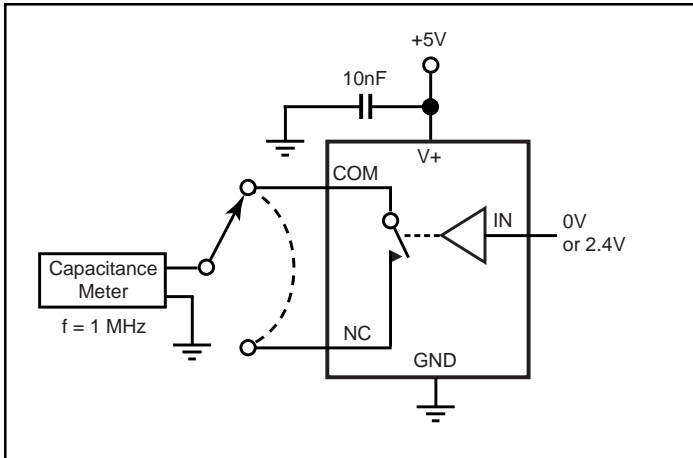

Figure 6. Channel-Off Capacitance

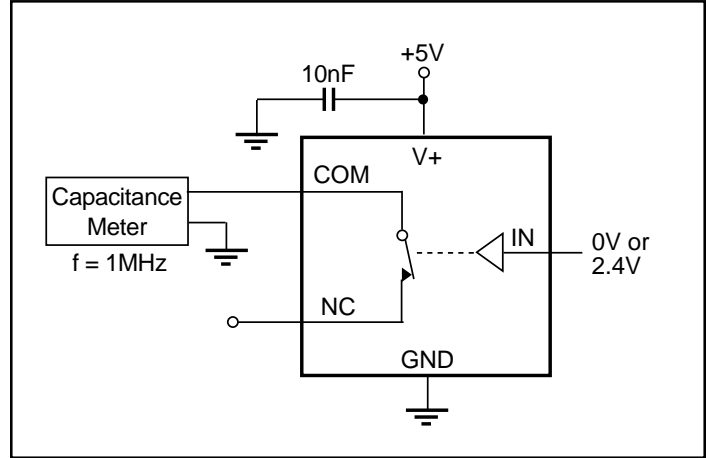

Figure 7. Channel-On Capacitance

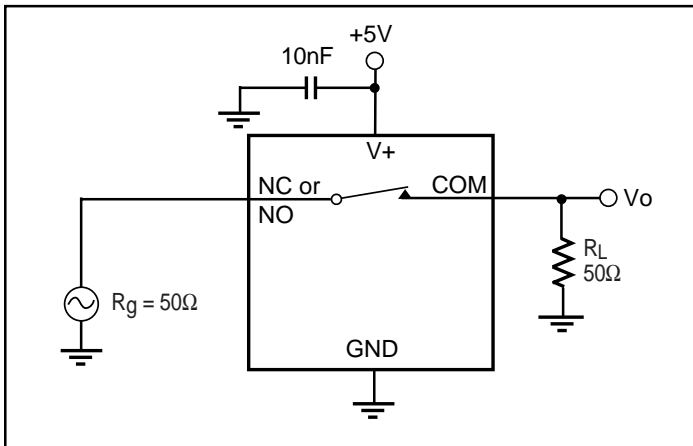
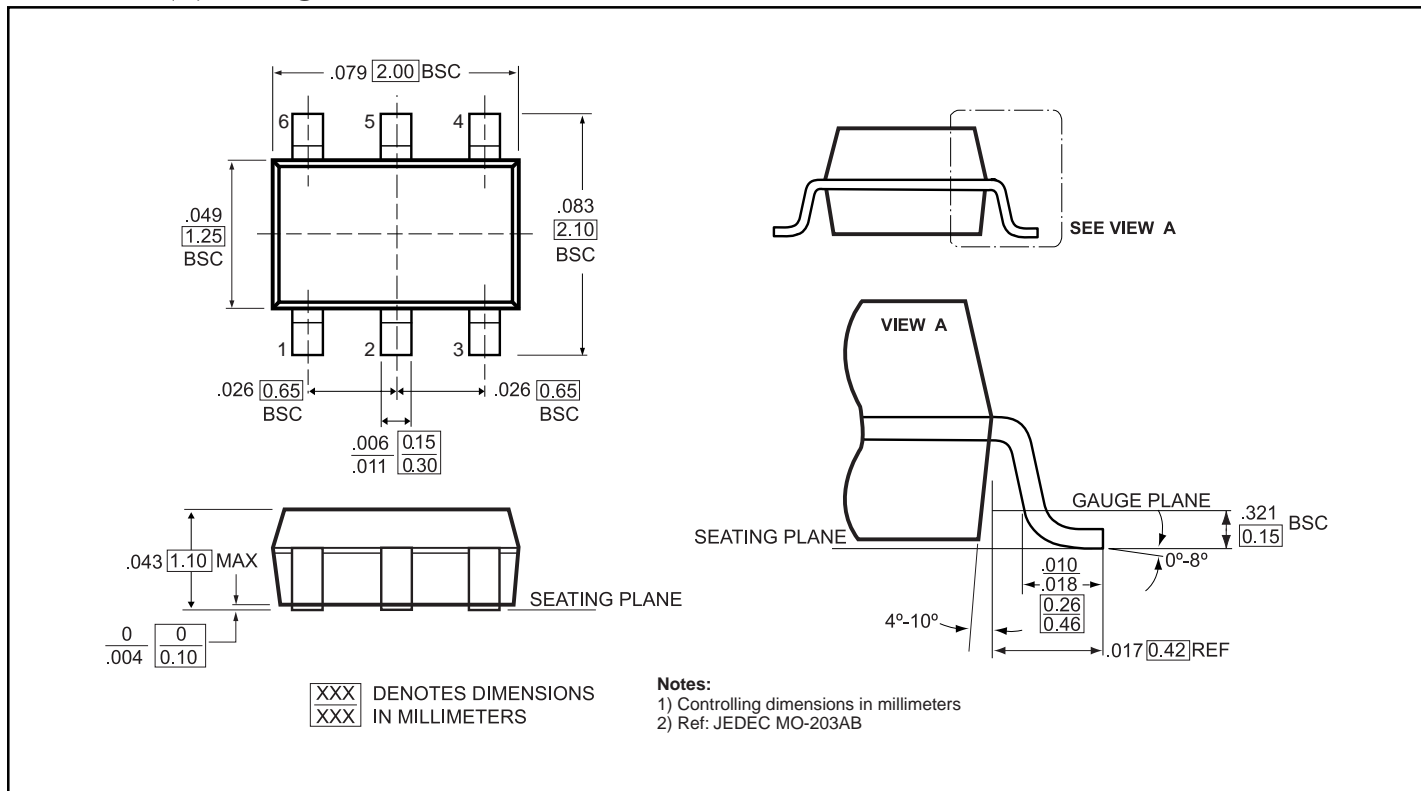

Figure 8. Bandwidth

6-Pin SC70 (C) Package



Ordering Information

Part Number	Package	Package Top Mark
PI5A4599ACX	SC70-6	A63