

# High Voltage NPN Silicon Power Transistors

... designed for high voltage inverters, switching regulators and line-operated amplifier applications. Especially well suited for switching power supply applications.

- High Collector–Emitter Sustaining Voltage –  
 $V_{CE(sus)} = 250 \text{ Vdc (Min)}$
- Excellent DC Current Gain  
 $h_{FE} = 10\text{--}75 @ I_C = 2.5 \text{ Adc}$
- Low Collector–Emitter Saturation Voltage @  $I_C = 2.5 \text{ Adc}$  –  
 $V_{CE(sat)} = 1.0 \text{ Vdc (Max)}$

## MAXIMUM RATINGS (1)

Rating	Symbol	Value	Unit
Collector–Emitter Voltage	$V_{CEO}$	250	Vdc
Collector–Base Voltage	$V_{CB}$	350	Vdc
Emitter–Base Voltage	$V_{EB}$	6.0	Vdc
Collector Current – Continuous – Peak	$I_C$	5.0 10	A <sub>dc</sub>
Base Current	$I_B$	2.0	A <sub>dc</sub>
Total Power Dissipation @ $T_C = 25^\circ\text{C}$ Derate above $25^\circ\text{C}$	$P_D$	80 0.64	Watts W/ $^\circ\text{C}$
Operating and Storage Junction Temperature Range	$T_J, T_{stg}$	–65 to +150	$^\circ\text{C}$

## THERMAL CHARACTERISTICS

Characteristic	Symbol	Max	Unit
Thermal Resistance, Junction to Case	$R_{\theta JC}$	1.56	$^\circ\text{C/W}$

(1) Indicates JEDEC Registered Data.

**2N6497**

**5 AMPERE  
POWER TRANSISTORS  
NPN SILICON  
250 VOLT  
80 WATTS**

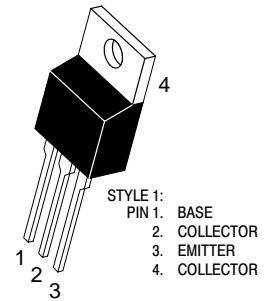

**CASE 221A–09  
TO–220AB**

# 2N6497

\*ELECTRICAL CHARACTERISTICS ( $T_C = 25^\circ\text{C}$  unless otherwise noted)

Characteristic	Symbol	Min	Typ	Max	Unit
<b>OFF CHARACTERISTICS</b>					
Collector–Emitter Sustaining Voltage (1) ( $I_C = 25\text{ mAdc}$ , $I_B = 0$ )	$V_{CEO(sus)}$	250	–	–	Vdc
Collector Cutoff Current ( $V_{CE} = 350\text{ Vdc}$ , $V_{BE(off)} = 1.5\text{ Vdc}$ ) ( $V_{CE} = 175\text{ Vdc}$ , $V_{BE(off)} = 1.5\text{ Vdc}$ , $T_C = 100^\circ\text{C}$ )	$I_{CEX}$	–	–	1.0 10	mAdc
Emitter Cutoff Current ( $V_{BE} = 6.0\text{ Vdc}$ , $I_C = 0$ )	$I_{EBO}$	–	–	1.0	mAdc

## ON CHARACTERISTICS (1)

DC Current Gain ( $I_C = 2.5\text{ Adc}$ , $V_{CE} = 10\text{ Vdc}$ ) ( $I_C = 5.0\text{ Adc}$ , $V_{CE} = 10\text{ Vdc}$ )	$h_{FE}$	10 3.0	– –	75 –	–
Collector–Emitter Saturation Voltage ( $I_C = 2.5\text{ Adc}$ , $I_B = 500\text{ mAdc}$ ) ( $I_C = 5.0\text{ Adc}$ , $I_B = 2.0\text{ Adc}$ )	$V_{CE(sat)}$	– –	– –	1.0 5.0	Vdc
Base–Emitter Saturation Voltage ( $I_C = 2.5\text{ Adc}$ , $I_B = 500\text{ mAdc}$ ) ( $I_C = 5.0\text{ Adc}$ , $I_B = 2.0\text{ Adc}$ )	$V_{BE(sat)}$	– –	– –	1.5 2.5	Vdc

## DYNAMIC CHARACTERISTICS

Current–Gain – Bandwidth Product ( $I_C = 250\text{ mAdc}$ , $V_{CE} = 10\text{ Vdc}$ , $f = 1.0\text{ MHz}$ )	$f_T$	5.0	–	–	MHz
Output Capacitance ( $V_{CB} = 10\text{ Vdc}$ , $I_E = 0$ , $f = 100\text{ kHz}$ )	$C_{ob}$	–	–	150	pF

## SWITCHING CHARACTERISTICS

Rise Time ( $V_{CC} = 125\text{ Vdc}$ , $I_C = 2.5\text{ Adc}$ , $I_{B1} = 0.5\text{ Adc}$ )	$t_r$	–	0.4	1.0	$\mu\text{s}$
Storage Time ( $V_{CC} = 125\text{ Vdc}$ , $I_C = 2.5\text{ Adc}$ , $V_{BE} = 5.0\text{ Vdc}$ , $I_{B1} = I_{B2} = 0.5\text{ Adc}$ )	$t_s$	–	1.4	2.5	$\mu\text{s}$
Fall Time ( $V_{CC} = 125\text{ Vdc}$ , $I_C = 2.5\text{ Adc}$ , $I_{B1} = I_{B2} = 0.5\text{ Adc}$ )	$t_f$	–	0.45	1.0	$\mu\text{s}$

\*Indicates JEDEC Registered Data.

(1) Pulse Test: Pulse Width  $\leq 300\ \mu\text{s}$ , Duty Cycle  $\leq 2.0\%$ .

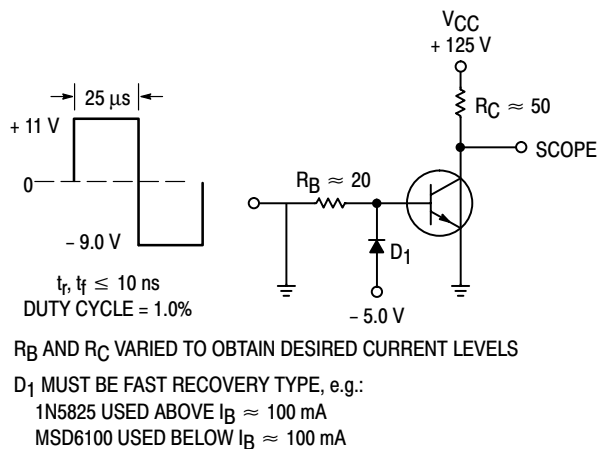

Figure 1. Switching Time Test Circuit

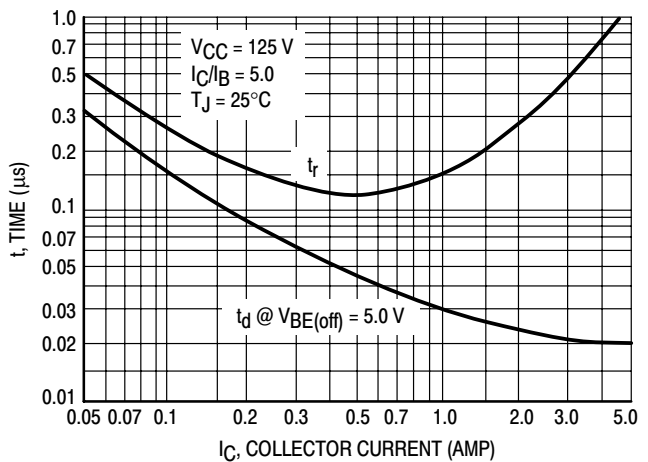

Figure 2. Turn–On Time

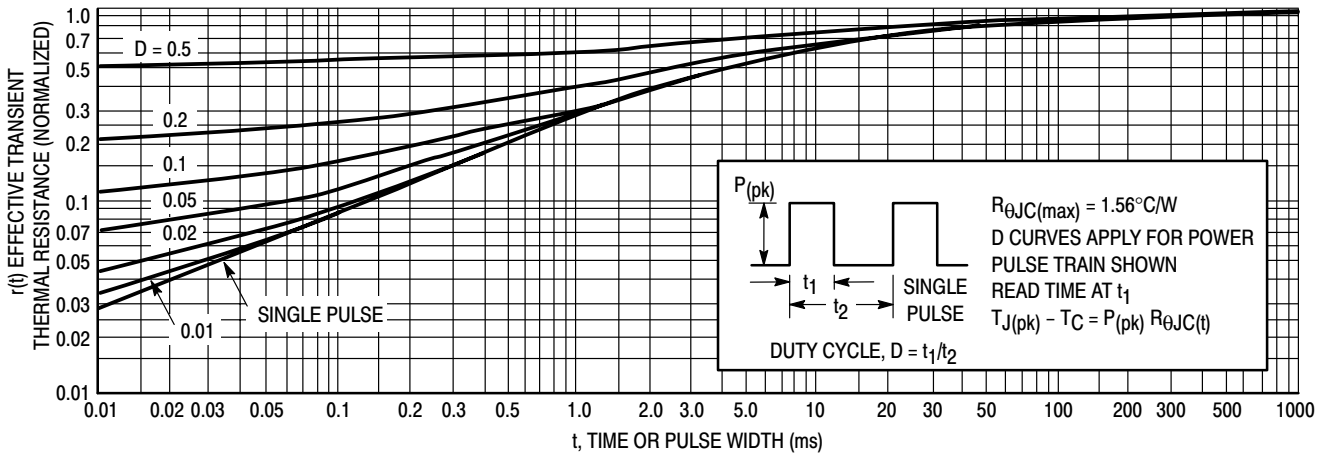

Figure 3. Thermal Response

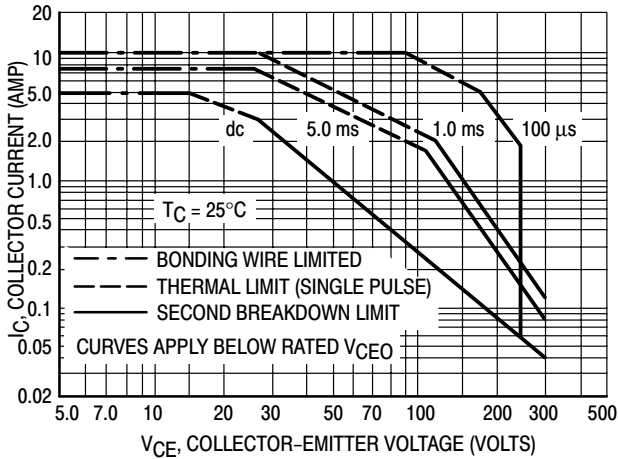

Figure 4. Active-Region Safe Operating Area

There are two limitations on the power handling ability of a transistor: average junction temperature and second breakdown. Safe operating area curves indicate  $I_C - V_{CE}$  limits of the transistor that must be observed for reliable operation; i.e., the transistor must not be subjected to greater dissipation than the curves indicate.

The data of Figure 4 is based on  $T_C = 25^{\circ}C$ ;  $T_J(pk)$  is variable depending on power level. Second breakdown pulse limits are valid for duty cycles to 10% provided  $T_J(pk) \leq 150^{\circ}C$ .  $T_J(pk)$  may be calculated from the data in Figure 3. At high case temperatures, thermal limitations will reduce the power that can be handled to values less than the limitations imposed by second breakdown. Second breakdown limitations do not derate the same as thermal limitations. Allowable current at the voltage shown on Figure 4 may be found at any case temperature by using the appropriate curve on Figure 6.

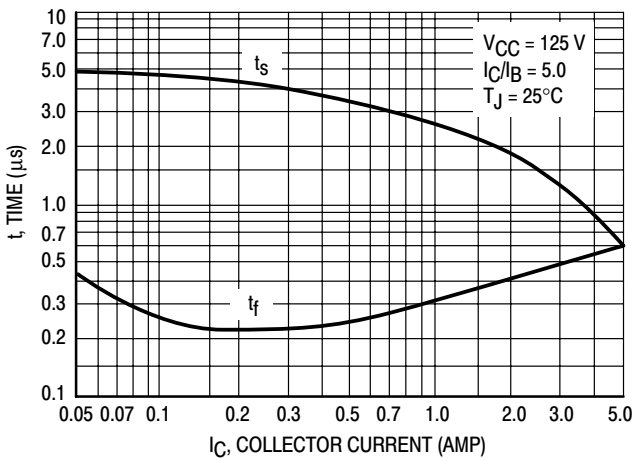

Figure 5. Turn-Off Time

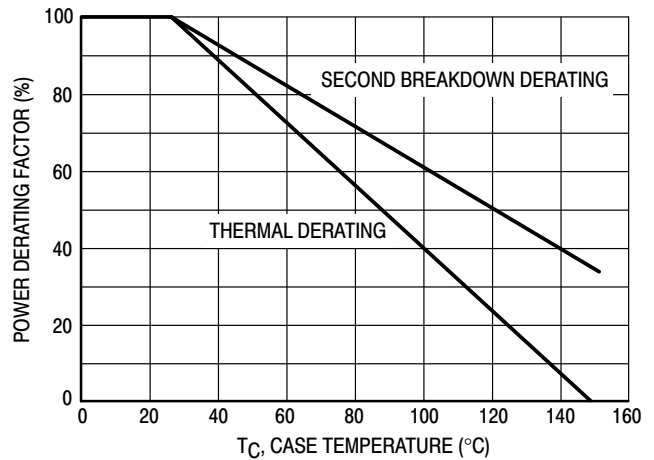

Figure 6. Power Derating

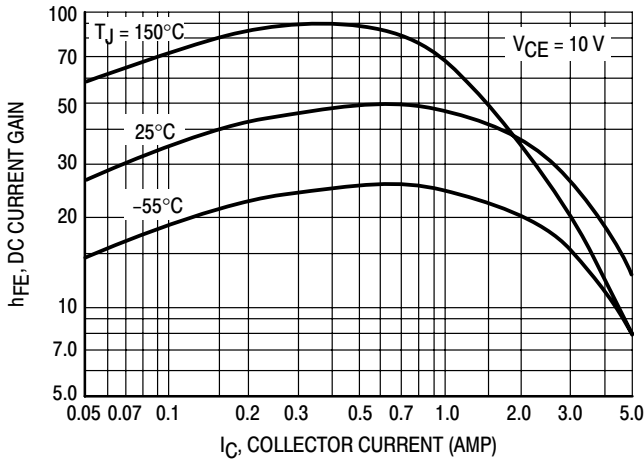

Figure 7. DC Current Gain

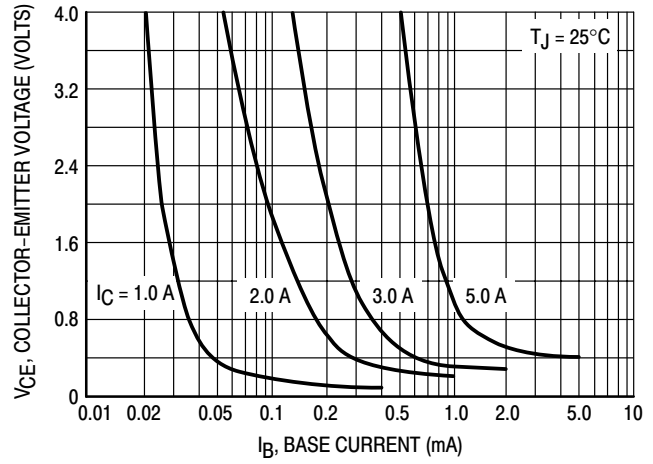

Figure 8. Collector Saturation Region

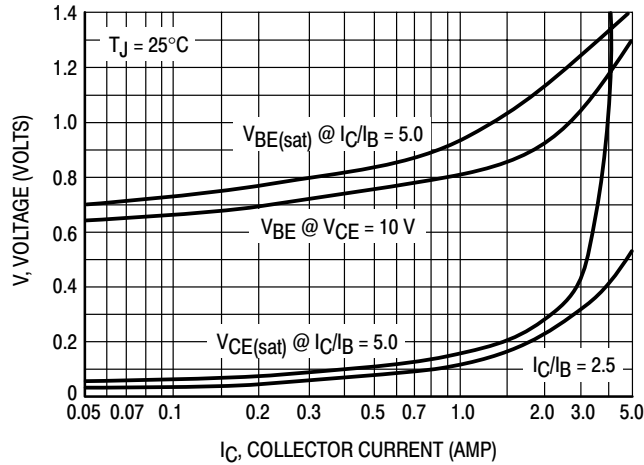

Figure 9. "On" Voltages

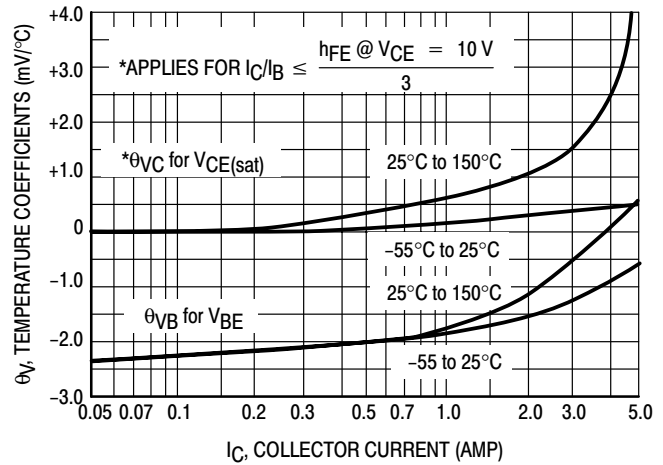

Figure 10. Temperature Coefficients

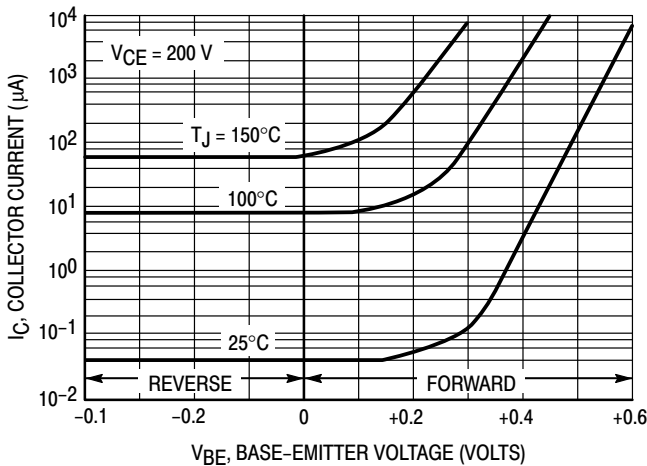

Figure 11. Collector Cutoff Region

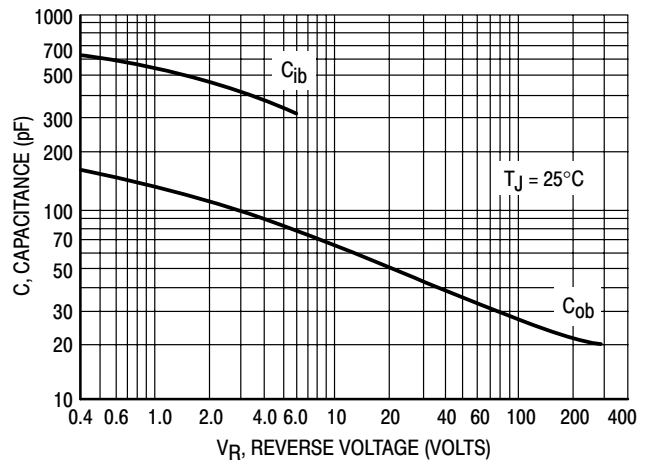
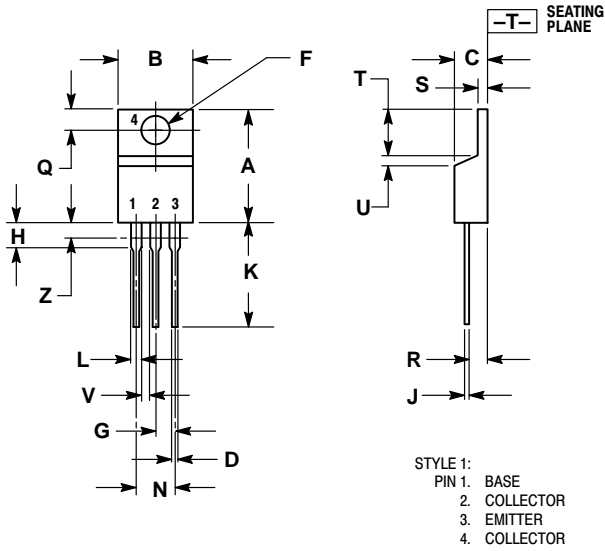

Figure 12. Capacitance

# 2N6497

## PACKAGE DIMENSIONS

### TO-220AB CASE 221A-09 ISSUE AA



NOTES:

1. DIMENSIONING AND TOLERANCING PER ANSI Y14.5M, 1982.
2. CONTROLLING DIMENSION: INCH.
3. DIMENSION Z DEFINES A ZONE WHERE ALL BODY AND LEAD IRREGULARITIES ARE ALLOWED.

DIM	INCHES		MILLIMETERS	
	MIN	MAX	MIN	MAX
A	0.570	0.620	14.48	15.75
B	0.380	0.405	9.66	10.28
C	0.160	0.190	4.07	4.82
D	0.025	0.035	0.64	0.88
F	0.142	0.147	3.61	3.73
G	0.095	0.105	2.42	2.66
H	0.110	0.155	2.80	3.93
J	0.018	0.025	0.46	0.64
K	0.500	0.562	12.70	14.27
L	0.045	0.060	1.15	1.52
N	0.190	0.210	4.83	5.33
Q	0.100	0.120	2.54	3.04
R	0.080	0.110	2.04	2.79
S	0.045	0.055	1.15	1.39
T	0.235	0.255	5.97	6.47
U	0.000	0.050	0.00	1.27
V	0.045	---	1.15	---
Z	---	0.080	---	2.04

## Notes

# Notes

**ON Semiconductor** and  are registered trademarks of Semiconductor Components Industries, LLC (SCILLC). SCILLC reserves the right to make changes without further notice to any products herein. SCILLC makes no warranty, representation or guarantee regarding the suitability of its products for any particular purpose, nor does SCILLC assume any liability arising out of the application or use of any product or circuit, and specifically disclaims any and all liability, including without limitation special, consequential or incidental damages. "Typical" parameters which may be provided in SCILLC data sheets and/or specifications can and do vary in different applications and actual performance may vary over time. All operating parameters, including "Typicals" must be validated for each customer application by customer's technical experts. SCILLC does not convey any license under its patent rights nor the rights of others. SCILLC products are not designed, intended, or authorized for use as components in systems intended for surgical implant into the body, or other applications intended to support or sustain life, or for any other application in which the failure of the SCILLC product could create a situation where personal injury or death may occur. Should Buyer purchase or use SCILLC products for any such unintended or unauthorized application, Buyer shall indemnify and hold SCILLC and its officers, employees, subsidiaries, affiliates, and distributors harmless against all claims, costs, damages, and expenses, and reasonable attorney fees arising out of, directly or indirectly, any claim of personal injury or death associated with such unintended or unauthorized use, even if such claim alleges that SCILLC was negligent regarding the design or manufacture of the part. SCILLC is an Equal Opportunity/Affirmative Action Employer.

**PUBLICATION ORDERING INFORMATION**

**Literature Fulfillment:**

Literature Distribution Center for ON Semiconductor  
P.O. Box 5163, Denver, Colorado 80217 USA  
**Phone:** 303-675-2175 or 800-344-3860 Toll Free USA/Canada  
**Fax:** 303-675-2176 or 800-344-3867 Toll Free USA/Canada  
**Email:** ONlit@hibbertco.com

**N. American Technical Support:** 800-282-9855 Toll Free USA/Canada

**JAPAN:** ON Semiconductor, Japan Customer Focus Center  
4-32-1 Nishi-Gotanda, Shinagawa-ku, Tokyo, Japan 141-0031  
**Phone:** 81-3-5740-2700  
**Email:** r14525@onsemi.com

**ON Semiconductor Website:** <http://onsemi.com>

For additional information, please contact your local Sales Representative.