

# BCR12CS

MEDIUM POWER USE  
NON-INSULATED TYPE, PLANAR PASSIVATION TYPE

**BCR12CS**



- **IT (RMS)** ..... **12A**
- **VDRM** ..... **400V/600V**
- **IFGT I , IRGT I , IRGT III** ..... **30mA (20mA) \*5**

**OUTLINE DRAWING** Dimensions in mm

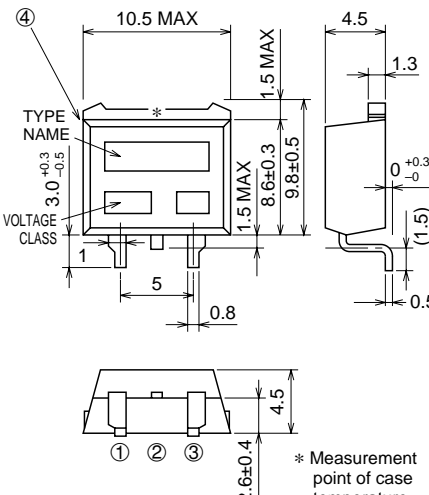

\* Measurement point of case temperature

① T1 TERMINAL  
② T2 TERMINAL  
③ GATE TERMINAL  
④ T2 TERMINAL

TO-220S

## APPLICATION

Solid state relay, hybrid IC

## MAXIMUM RATINGS

Symbol	Parameter	Voltage class		Unit
		8	12	
VDRM	Repetitive peak off-state voltage *1	400	600	V
VDSM	Non-repetitive peak off-state voltage *1	500	720	V

Symbol	Parameter	Conditions	Ratings	Unit
IT (RMS)	RMS on-state current	Commercial frequency, sine full wave 360° conduction, Tc=98°C	12	A
ITSM	Surge on-state current	60Hz sinewave 1 full cycle, peak value, non-repetitive	120	A
I <sup>2</sup> t	I <sup>2</sup> t for fusing	Value corresponding to 1 cycle of half wave 60Hz, surge on-state current	60	A <sup>2</sup> s
PGM	Peak gate power dissipation		5	W
PG (AV)	Average gate power dissipation		0.5	W
VGM	Peak gate voltage		10	V
IGM	Peak gate current		2	A
Tj	Junction temperature		-40 ~ +125	°C
Tstg	Storage temperature		-40 ~ +125	°C
—	Weight	Typical value	1.2	g

\*1. Gate open.

# BCR12CS

MEDIUM POWER USE

NON-INSULATED TYPE, PLANAR PASSIVATION TYPE

## ELECTRICAL CHARACTERISTICS

Symbol	Parameter	Test conditions	Limits			Unit	
			Min.	Typ.	Max.		
IDRM	Repetitive peak off-state current	$T_j=125^\circ\text{C}$ , $V_{\text{DRM}}$ applied	—	—	2.0	mA	
V <sub>TM</sub>	On-state voltage	$T_c=25^\circ\text{C}$ , $I_{\text{TM}}=20\text{A}$ , Instantaneous measurement	—	—	1.6	V	
V <sub>FGT I</sub>	Gate trigger voltage *2	$T_j=25^\circ\text{C}$ , $V_D=6\text{V}$ , $R_L=6\Omega$ , $R_G=330\Omega$	I	—	—	1.5	V
V <sub>RGT I</sub>			II	—	—	1.5	V
V <sub>RGT III</sub>			III	—	—	1.5	V
I <sub>FGT I</sub>	Gate trigger current *2	$T_j=25^\circ\text{C}$ , $V_D=6\text{V}$ , $R_L=6\Omega$ , $R_G=330\Omega$	I	—	—	30*5	mA
I <sub>RGT I</sub>			II	—	—	30*5	mA
I <sub>RGT III</sub>			III	—	—	30*5	mA
V <sub>GD</sub>	Gate non-trigger voltage	$T_j=125^\circ\text{C}$ , $V_D=1/2V_{\text{DRM}}$	0.2	—	—	V	
R <sub>th(j-c)</sub>	Thermal resistance	Junction to case *4	—	—	1.8	$^\circ\text{C}/\text{W}$	
(dv/dt) <sub>c</sub>	Critical-rate of rise of off-state commutating voltage		*3	—	—	V/ $\mu\text{s}$	

\*2. Measurement using the gate trigger characteristics measurement circuit.  
 \*3. The critical-rate of rise of the off-state commutating voltage is shown in the table below.  
 \*4. The contact thermal resistance R<sub>th(c-f)</sub> in case of greasing is 1.0 $^\circ\text{C}/\text{W}$ .  
 \*5. High sensitivity (IGT $\leq$ 20mA) is also available. (IGT item ①)

Voltage class	V <sub>DRM</sub> (V)	(dv/dt) <sub>c</sub>			Test conditions	Commutating voltage and current waveforms (inductive load)
		Symbol	Min.	Unit		
8	400	R	—	V/ $\mu\text{s}$	1. Junction temperature $T_j=125^\circ\text{C}$ 2. Rate of decay of on-state commutating current $(di/dt)_c=-6\text{A}/\text{ms}$ 3. Peak off-state voltage $V_D=400\text{V}$	
		L	10			
12	600	R	—			
		L	10			

## PERFORMANCE CURVES

MAXIMUM ON-STATE CHARACTERISTICS

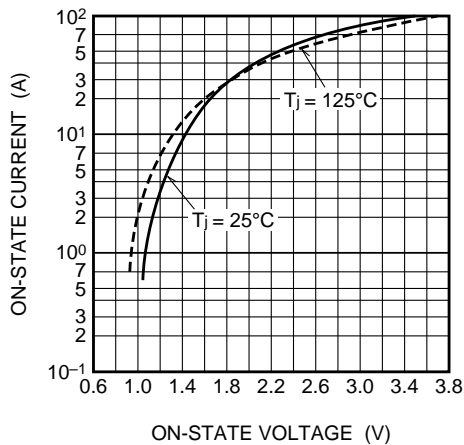

RATED SURGE ON-STATE CURRENT

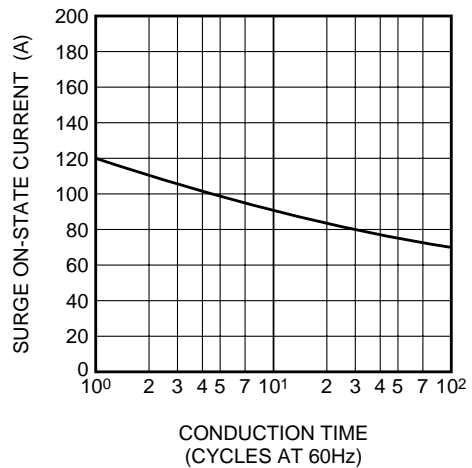

# BCR12CS

MEDIUM POWER USE

NON-INSULATED TYPE, PLANAR PASSIVATION TYPE

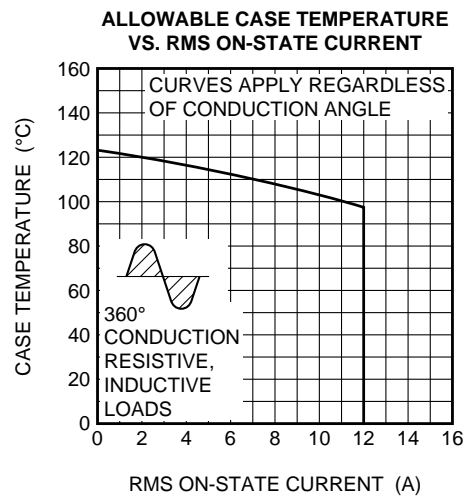
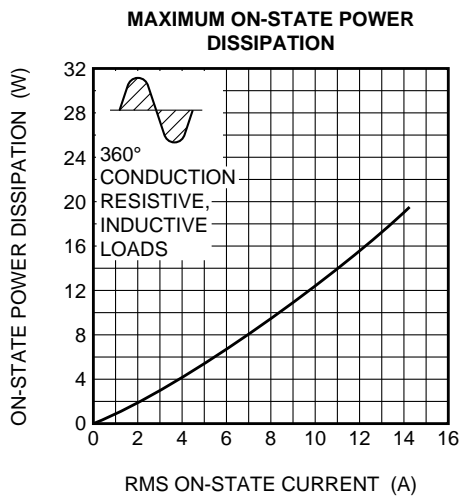
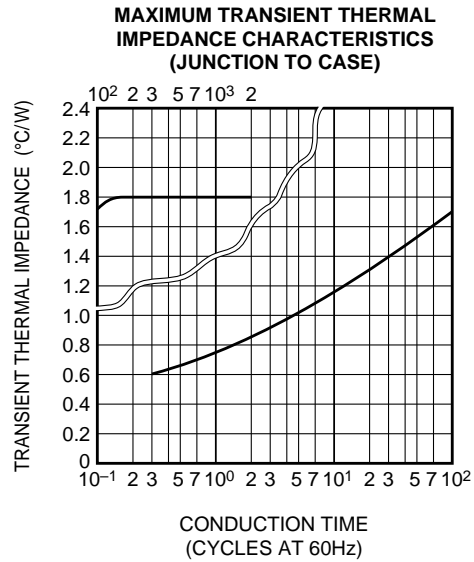
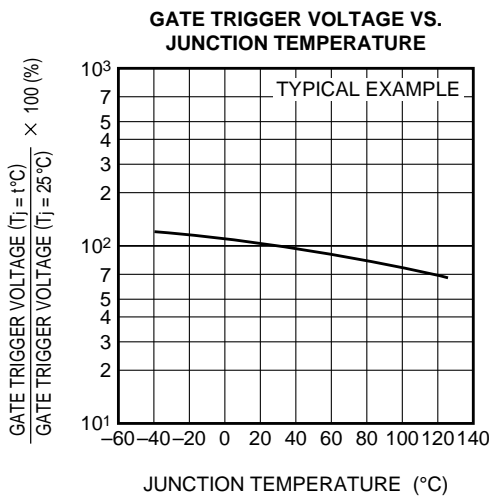
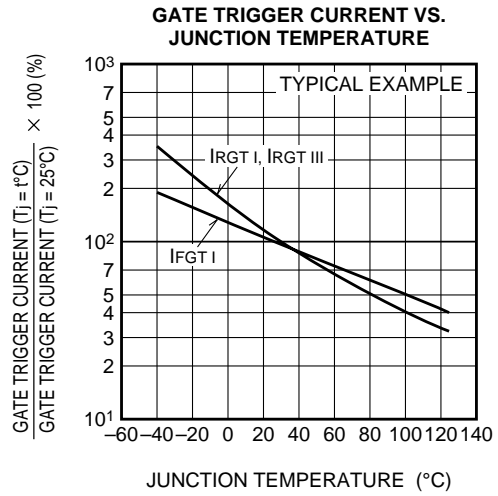
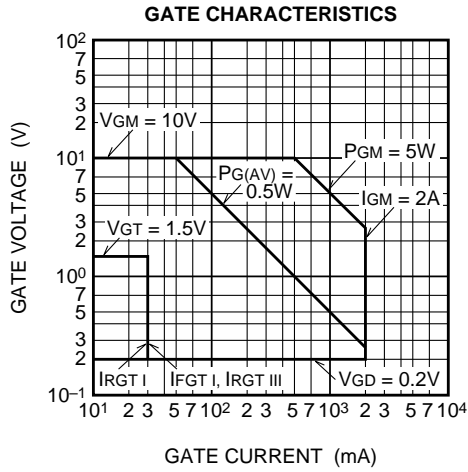

# BCR12CS

MEDIUM POWER USE

NON-INSULATED TYPE, PLANAR PASSIVATION TYPE

**ALLOWABLE AMBIENT TEMPERATURE VS. RMS ON-STATE CURRENT**

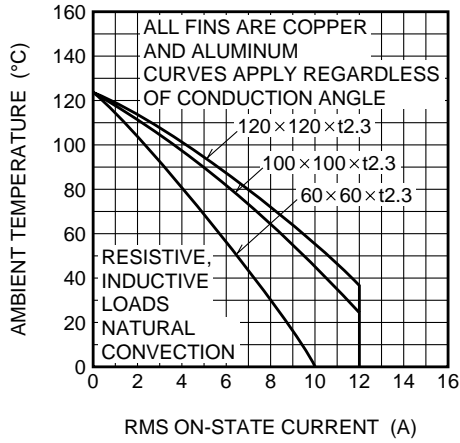

**ALLOWABLE AMBIENT TEMPERATURE VS. RMS ON-STATE CURRENT**

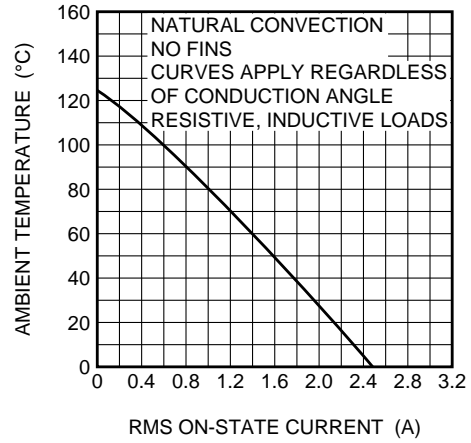

**REPETITIVE PEAK OFF-STATE CURRENT VS. JUNCTION TEMPERATURE**

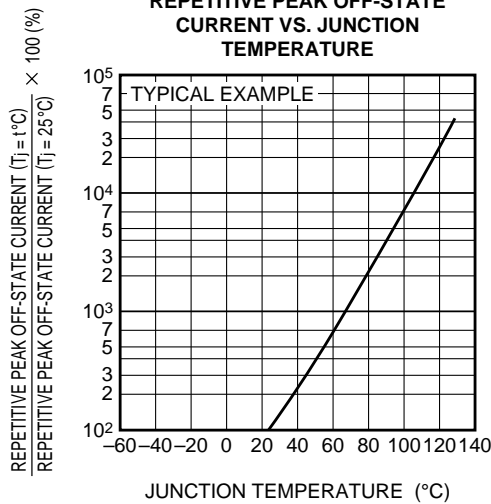

**HOLDING CURRENT VS. JUNCTION TEMPERATURE**

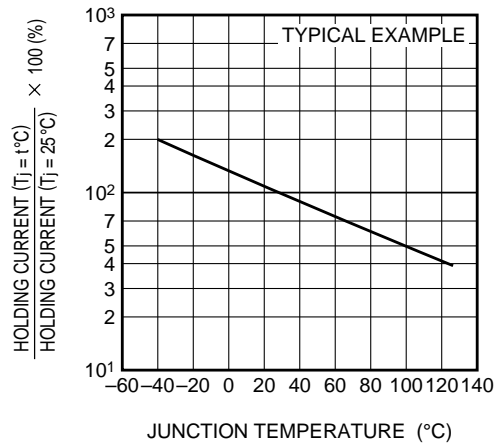

**LATCHING CURRENT VS. JUNCTION TEMPERATURE**

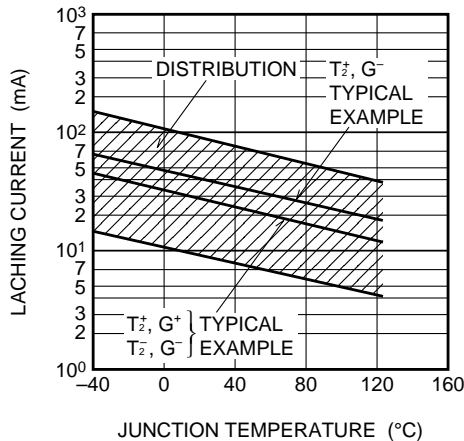

**BREAKOVER VOLTAGE VS. JUNCTION TEMPERATURE**

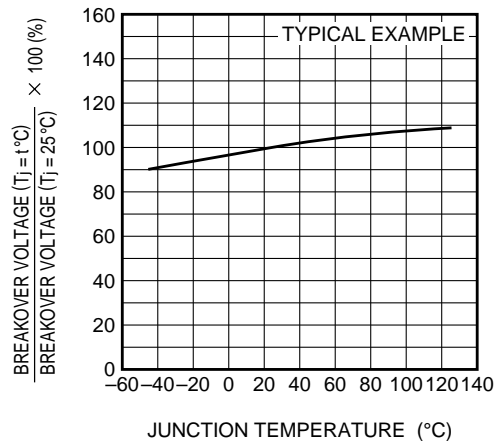

# BCR12CS

MEDIUM POWER USE

NON-INSULATED TYPE, PLANAR PASSIVATION TYPE

**BREAKOVER VOLTAGE VS. RATE OF RISE OF OFF-STATE VOLTAGE**

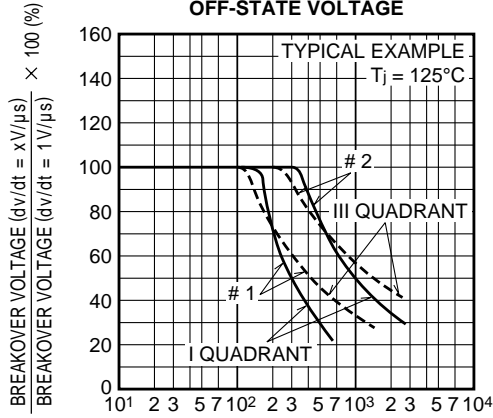

RATE OF RISE OF OFF-STATE VOLTAGE (V/μs)

**COMMUTATION CHARACTERISTICS**

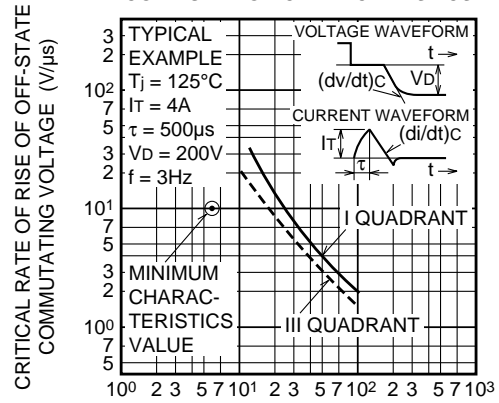

RATE OF DECAY OF ON-STATE COMMUTATING CURRENT (A/ms)

**GATE TRIGGER CURRENT VS. GATE CURRENT PULSE WIDTH**

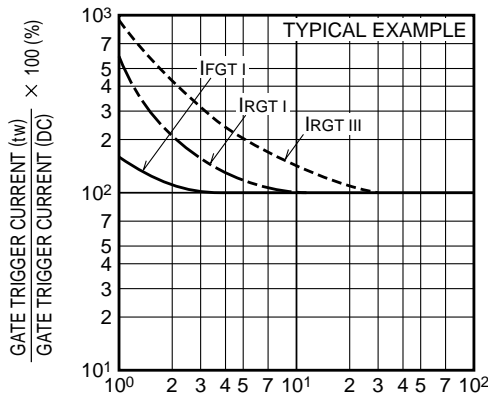

GATE CURRENT PULSE WIDTH (μs)

**GATE TRIGGER CHARACTERISTICS TEST CIRCUITS**

