

TPC8206

Lithium Ion Battery Applications
 Notebook PC Applications
 Portable Equipment Applications

- Small footprint due to small and thin package
- Low drain-source ON resistance: $R_{DS(ON)} = 40 \text{ m}\Omega$ (typ.)
- High forward transfer admittance: $|Y_{fs}| = 7.0 \text{ S}$ (typ.)
- Low leakage current: $I_{DSS} = 10 \text{ }\mu\text{A}$ (max) ($V_{DS} = 60 \text{ V}$)
- Enhancement mode: $V_{th} = 1.3 \text{ to } 2.5 \text{ V}$ ($V_{DS} = 10 \text{ V}$, $I_D = 1 \text{ mA}$)

Maximum Ratings ($T_a = 25^\circ\text{C}$)

Characteristics		Symbol	Rating	Unit
Drain-source voltage		V_{DSS}	60	V
Drain-gate voltage ($R_{GS} = 20 \text{ k}\Omega$)		V_{DGR}	60	V
Gate-source voltage		V_{GSS}	± 20	V
Drain current	DC (Note 1)	I_D	5	A
	Pulse (Note 1)	I_{DP}	20	
Drain power dissipation ($t = 10 \text{ s}$) (Note 2a)	Single-device operation (Note 3a)	$P_D(1)$	1.5	W
	Single-device value at dual operation (Note 3b)	$P_D(2)$	1.0	
Drain power dissipation ($t = 10 \text{ s}$) (Note 2b)	Single-device operation (Note 3a)	$P_D(1)$	0.75	W
	Single-device value at dual operation (Note 3b)	$P_D(2)$	0.45	
Single pulse avalanche energy (Note 4)		E_{AS}	92	mJ
Avalanche current		I_{AR}	5	A
Repetitive avalanche energy Single-device value at dual operation (Note 2a, 3b, 5)		E_{AR}	0.1	mJ
Channel temperature		T_{ch}	150	$^\circ\text{C}$
Storage temperature range		T_{stg}	-55 to 150	$^\circ\text{C}$

Note: For (Note 1), (Note 2), (Note 3), (Note 4) and (Note 5), please refer to the next page.

This transistor is an electrostatic sensitive device. Please handle with caution.

Unit: mm

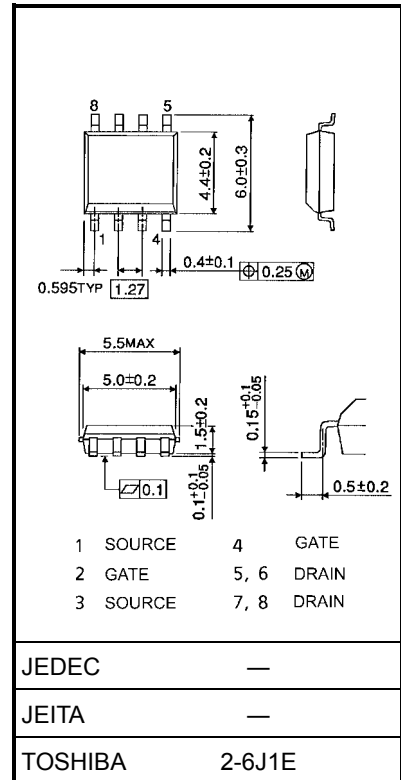

Weight: 0.080 g (typ.)

Circuit Configuration

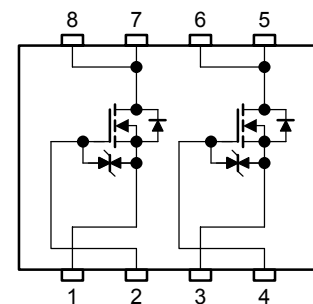

Thermal Characteristics

Characteristics		Symbol	Max	Unit
Thermal resistance, channel to ambient (t = 10 s) (Note 2a)	Single-device operation (Note 3a)	R _{th (ch-a) (1)}	83.3	°C/W
	Single-device value at dual operation (Note 3b)	R _{th (ch-a) (2)}	125	
Thermal resistance, channel to ambient (t = 10 s) (Note 2b)	Single-device operation (Note 3a)	R _{th (ch-a) (1)}	167	°C/W
	Single-device value at dual operation (Note 3b)	R _{th (ch-a) (2)}	278	

Marking (Note 6)

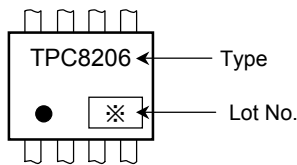

Note 1: Please use devices on condition that the channel temperature is below 150°C.

Note 2:

a) Device mounted on a glass-epoxy board (a)

b) Device mounted on a glass-epoxy board (b)

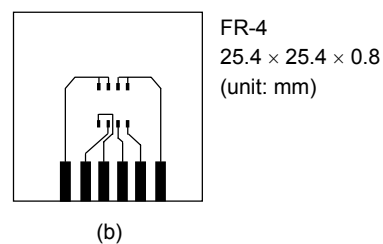
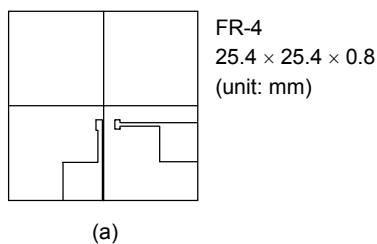

Note 3:

- a) The power dissipation and thermal resistance values are shown for a single device. (During single-device operation, power is only applied to one device.)
- b) The power dissipation and thermal resistance values are shown for a single device. (During dual operation, power is evenly applied to both devices.)

Note 4: V_{DD} = 25 V, T_{ch} = 25°C (initial), L = 5.0 mH, R_G = 25 Ω, I_{AR} = 5 A

Note 5: Repetitive rating; pulse width limited by maximum channel temperature

Note 6: • on lower left of the marking indicates Pin 1.

※ Weekly code: (Three digits)

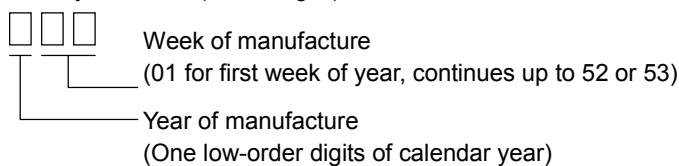

Electrical Characteristics (Ta = 25°C)

Characteristics		Symbol	Test Condition	Min	Typ.	Max	Unit
Gate leakage current		I_{GSS}	$V_{GS} = \pm 16\text{ V}, V_{DS} = 0\text{ V}$	—	—	± 10	μA
Drain cut-OFF current		I_{DSS}	$V_{DS} = 60\text{ V}, V_{GS} = 0\text{ V}$	—	—	10	μA
Drain-source breakdown voltage		$V_{(BR)DSS}$	$I_D = 10\text{ mA}, V_{GS} = 0\text{ V}$	60	—	—	V
		$V_{(BR)DSX}$	$I_D = 10\text{ mA}, V_{GS} = -12\text{ V}$	35	—	—	
Gate threshold voltage		V_{th}	$V_{DS} = 10\text{ V}, I_D = 1\text{ mA}$	1.3	—	2.5	V
Drain-source ON resistance		$R_{DS(ON)}$	$V_{GS} = 4\text{ V}, I_D = 2.5\text{ A}$	—	55	75	$\text{m}\Omega$
			$V_{GS} = 10\text{ V}, I_D = 2.5\text{ A}$	—	40	50	
Forward transfer admittance		$ Y_{fs} $	$V_{DS} = 10\text{ V}, I_D = 2.5\text{ A}$	3.5	7.0	—	S
Input capacitance		C_{iss}	$V_{DS} = 10\text{ V}, V_{GS} = 0\text{ V}, f = 1\text{ MHz}$	—	800	—	pF
Reverse transfer capacitance		C_{rss}		—	60	—	
Output capacitance		C_{oss}		—	190	—	
Switching time	Rise time	t_r	<p>$V_{GS} = 10\text{ V}$ 0 V $I_D = 2.5\text{ A}$ V_{OUT} $R_L = 12\ \Omega$ $V_{DD} \approx 30\text{ V}$ Duty $\leq 1\%$, $t_w = 10\ \mu\text{s}$</p>	—	2.6	—	ns
	Turn-ON time	t_{on}		—	10	—	
	Fall time	t_f		—	2.3	—	
	Turn-OFF time	t_{off}		—	22	—	
Total gate charge (gate-source plus gate-drain)		Q_g	$V_{DD} \approx 48\text{ V}, V_{GS} = 10\text{ V}, I_D = 5\text{ A}$	—	17	—	nC
Gate-source charge		Q_{gs}		—	12	—	
Gate-drain ("miller") charge		Q_{gd}		—	5	—	

Source-Drain Ratings and Characteristics (Ta = 25°C)

Characteristics		Symbol	Test Condition	Min	Typ.	Max	Unit
Drain reverse current	Pulse (Note 1)	I_{DRP}	—	—	—	20	A
Forward voltage (diode)		V_{DSF}	$I_{DR} = 5\text{ A}, V_{GS} = 0\text{ V}$	—	—	-1.2	V

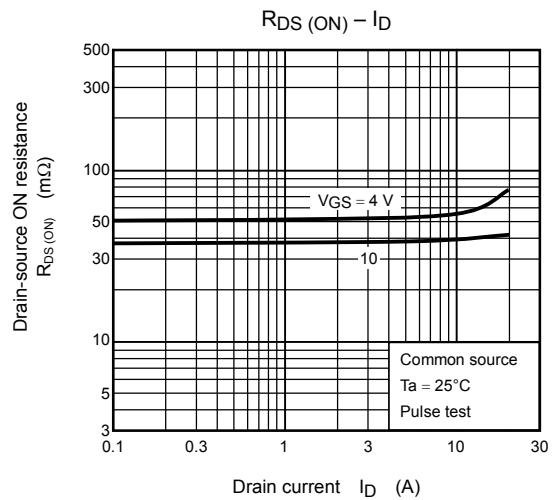
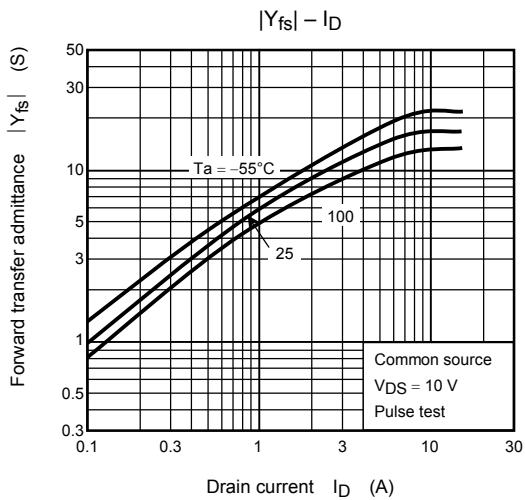
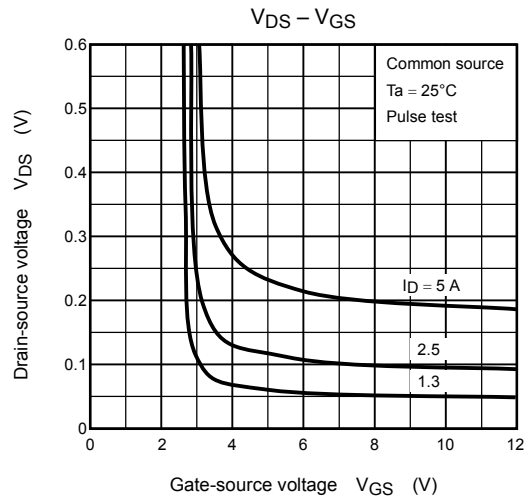
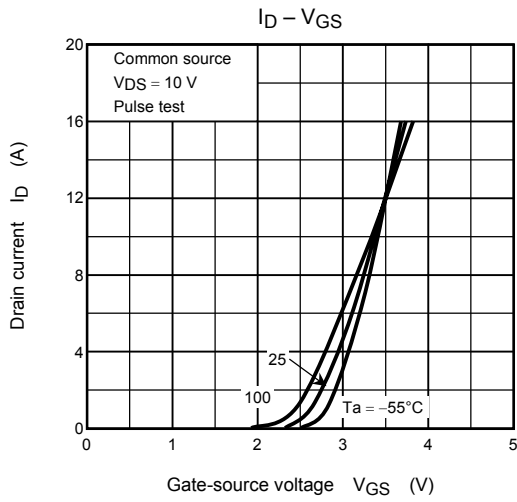
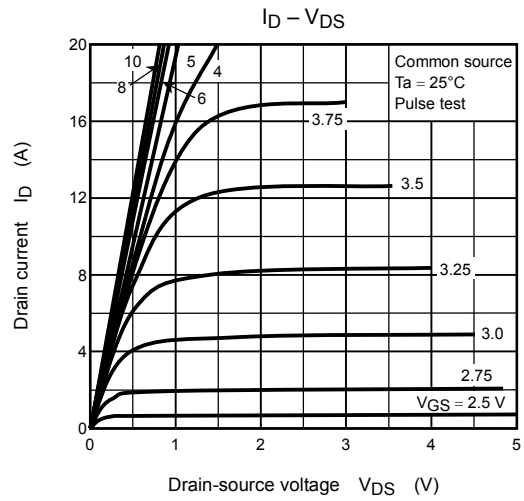
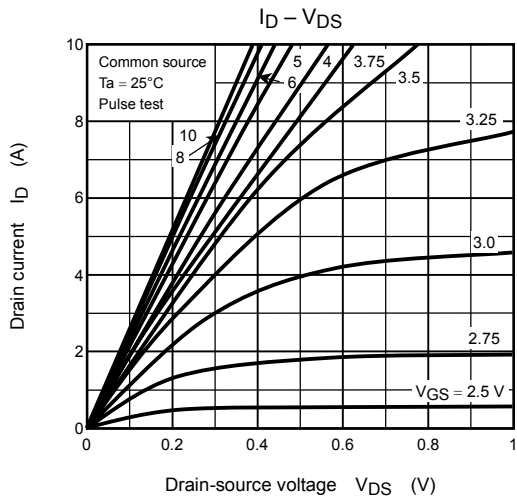

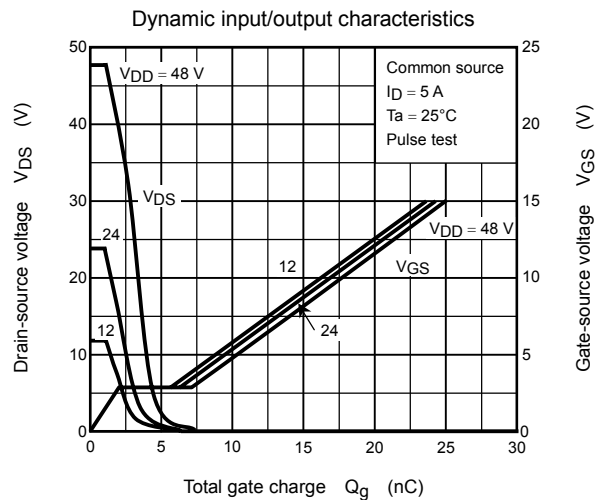
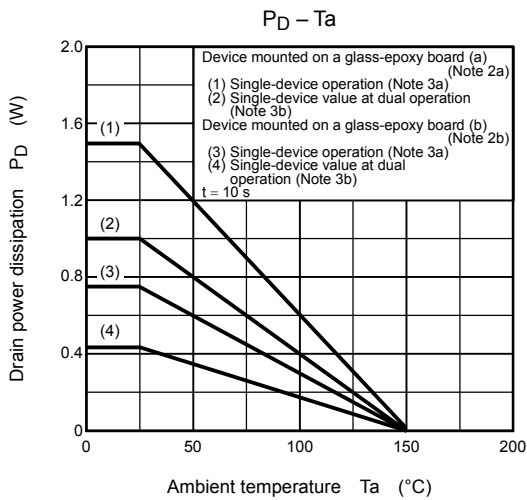
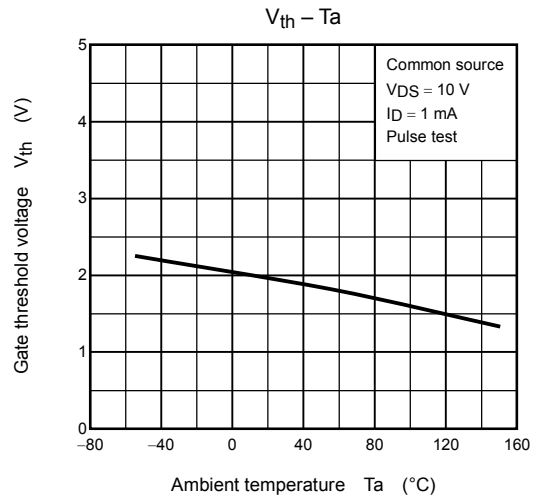
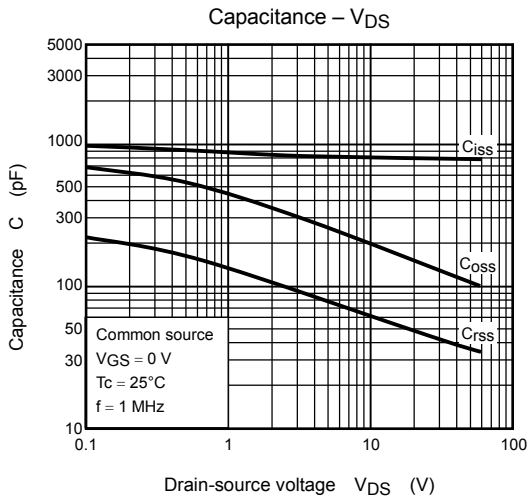
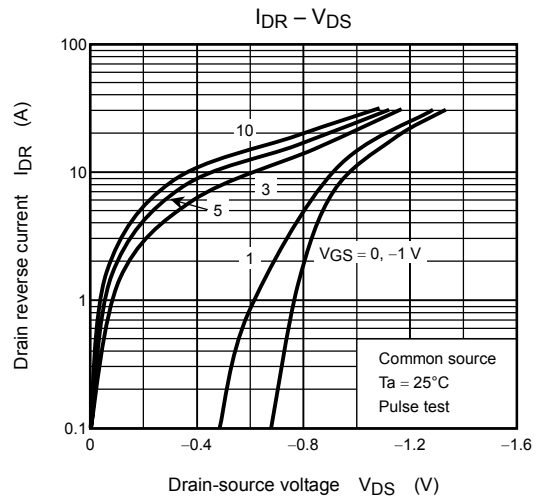
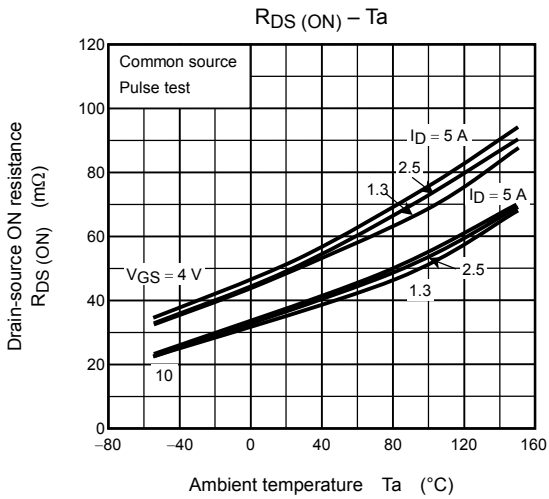

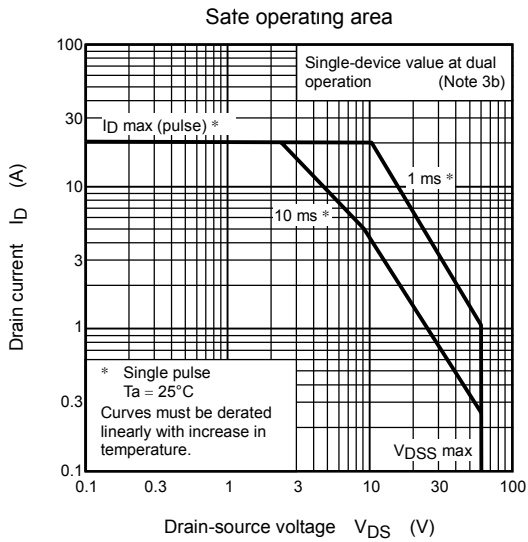
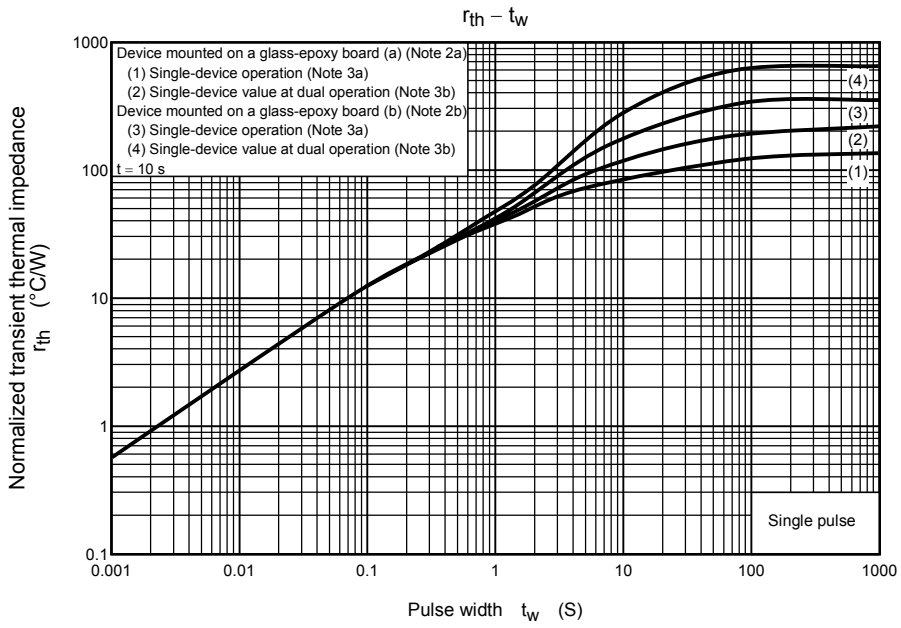

RESTRICTIONS ON PRODUCT USE

000707EAA

- TOSHIBA is continually working to improve the quality and reliability of its products. Nevertheless, semiconductor devices in general can malfunction or fail due to their inherent electrical sensitivity and vulnerability to physical stress. It is the responsibility of the buyer, when utilizing TOSHIBA products, to comply with the standards of safety in making a safe design for the entire system, and to avoid situations in which a malfunction or failure of such TOSHIBA products could cause loss of human life, bodily injury or damage to property.
In developing your designs, please ensure that TOSHIBA products are used within specified operating ranges as set forth in the most recent TOSHIBA products specifications. Also, please keep in mind the precautions and conditions set forth in the "Handling Guide for Semiconductor Devices," or "TOSHIBA Semiconductor Reliability Handbook" etc..
- The TOSHIBA products listed in this document are intended for usage in general electronics applications (computer, personal equipment, office equipment, measuring equipment, industrial robotics, domestic appliances, etc.). These TOSHIBA products are neither intended nor warranted for usage in equipment that requires extraordinarily high quality and/or reliability or a malfunction or failure of which may cause loss of human life or bodily injury ("Unintended Usage"). Unintended Usage include atomic energy control instruments, airplane or spaceship instruments, transportation instruments, traffic signal instruments, combustion control instruments, medical instruments, all types of safety devices, etc.. Unintended Usage of TOSHIBA products listed in this document shall be made at the customer's own risk.
- The information contained herein is presented only as a guide for the applications of our products. No responsibility is assumed by TOSHIBA CORPORATION for any infringements of intellectual property or other rights of the third parties which may result from its use. No license is granted by implication or otherwise under any intellectual property or other rights of TOSHIBA CORPORATION or others.
- The information contained herein is subject to change without notice.