

- ◆ 2ch DC/DC Controller (Step-up + Step-up)
- ◆ Input Voltage Range 0.9V ~ 10.0V
- ◆ Output Voltage Externally Set-Up
- ◆ Switching Frequency 180kHz (±15%)
- ◆ Max Duty Ratio 80% (TYP.)
- ◆ PWM, PWM/PFM Switching Control
- ◆ High Efficiency 83% (TYP.)
- ◆ MSOP-10 Package

■ General Description

The XC9501 series are PWM controlled, PWM/PFM automatic switching controlled, multi-functional, dual step-up DC/DC converter controller ICs.

With 0.9V (±2%) of standard voltage supply internal, and using externally connected components, output voltage can be set freely on both DC/DC controllers between 1.5V to 30V.

With a 180kHz frequency, the size of the external components can be reduced. 300kHz and 500kHz switching frequencies are also available as custom-designed products.

The control of the XC9501 series can be switched between PWM control and PWM/PFM automatic switching control using external signals. Control switches from PWM to PFM during light loads when automatic switching is selected and the series is highly efficient from light loads to large output currents.

Noise is easily reduced with PWM control since the switching frequency is fixed.

The XC9501 series provides the option of being able to select the control suited to the application.

Soft-start time is internally set to 10msec which offers protection against rush currents when the power is switched on and also against voltage overshoot.

■ Applications

- PDAs
- Palm top computers
- Portable Audio Systems
- Various Multi-function Power Supplies

■ Features

Input Voltage Range :0.9V ~ 10V
Power Supply Voltage Range :2.0V ~ 10V
Output Voltage Range :1.5V ~ 30V
 Can be set freely with 0.9V(±2.0%) of reference voltage supply & external components.

Switching Frequency :180kHz ±15%
 :300kHz & 500kHz available as custom

Output Current :more than 200mA(VIN=1.8V, VOUT=3.3V)
Stand-by Current :3.0µA (MAX)

Soft-start internally set-up
MSOP-10 Package

■ Typical Performance Characteristics

Efficiency vs. Output Current

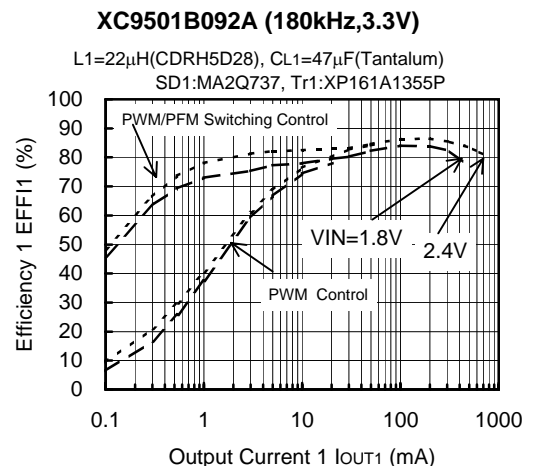

■ Typical Application

(XC9501B092A Input: 2 cells, Output ①: 3.3V, Output ②: 5.0V)

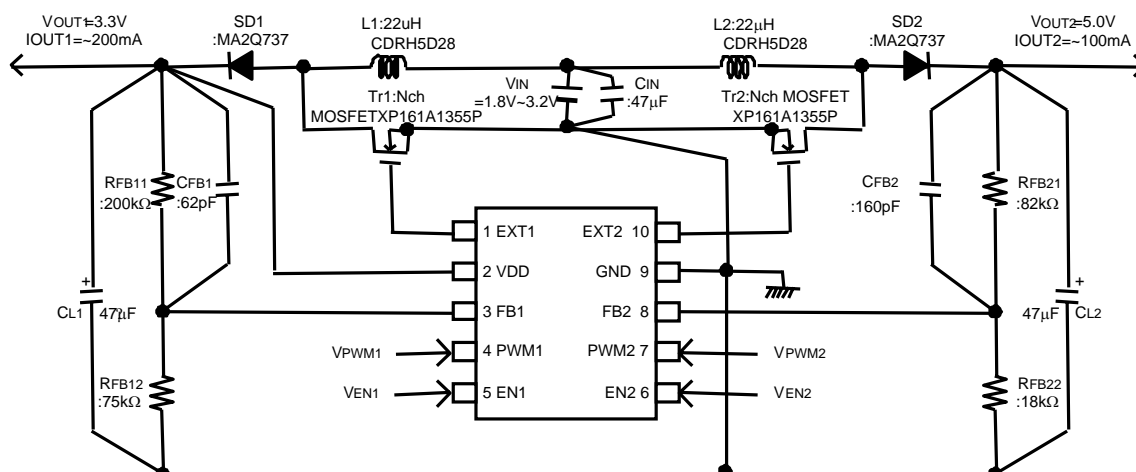

■ Pin Configuration

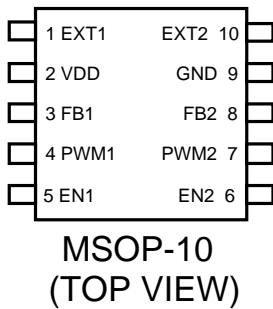

■ Pin Assignment

PIN NUMBER	PIN NAME	FUNCTIONS
1	EXT 1	Channel 1: External Transistor Drive Pin <Connected to Nch Power MOSFET Gate>
2	VDD	Supply Voltage
3	FB1	Channel 1 : Output Voltage Monitor Feedback Pin <Threshold value : 0.9V. Output voltage can be set freely by connecting split resistors between VOUT1 and Ground.>
4	PWM1	Channel 1 : PWM/PFM Switching Pin <Control Output 1. PWM control when connected to VDD, PWM / PFM auto switching when connected to Ground. >
5	EN1	Channel 1 : Enable Pin <Connected to VDD when Output 1 is in stand-by mode. Connected to VDD when Output 1 is active. EXT1 is low when in stand-by mode.>
6	EN2	Channel 2 : Enable Pin <Connected to Ground when Output 2 is in stand-by mode. Connected to VDD when Output 2 is active.EXT1 is high when in stand-by mode.>
7	PWM2	Channel 2 : PWM/PFM Switching Pin <Control Output 2. PWM control when connected to VDD, PWM / PFM auto switching when connected to Ground.>
8	FB2	Channel 2 : Output Voltage Monitor Feedback Pin <Threshold value : 0.9V. Output voltage can be set freely by connecting split resistors between VOUT2 and Ground.>
9	GND	Ground
10	EXT 2	Channel 2 : External Transistor Drive Pin <Connected to Nch Power MOSFET Gate>

■ Ordering Information

XC9501①②③④⑤⑥

DESIGNATOR	SYMBOL	DESCRIPTION	
①	B	Standard (10 Pin)	
②	0	FB Voltage	
③	9	0.9V	
④		Switching Frequency	
	2	180kHz	
	3	300kHz (custom)	
	5	500kHz (custom)	
⑤	A	Package	MSOP-10
⑥	R	Embossed Tape	Standard Feed
	L	Embossed Tape	Reverse Feed

■ Block Diagram

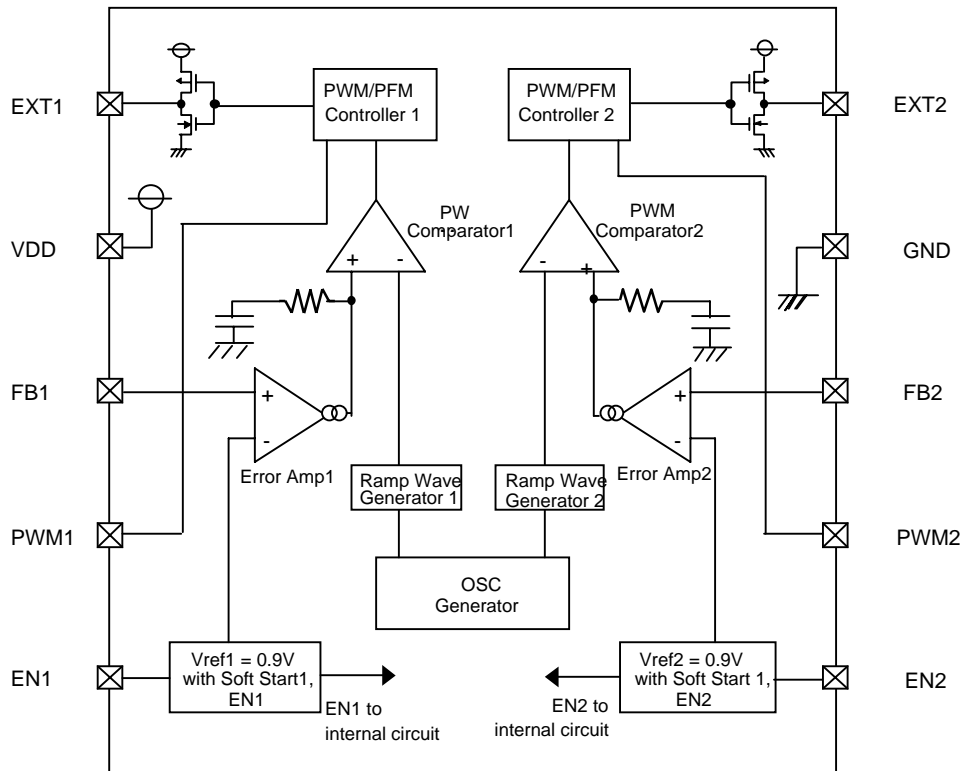

■ Absolute Maximum Ratings

Ta=25°C

PARAMETER	SYMBOL	RATINGS	UNITS
VDD Pin Voltage	VDD	- 0.3 ~ 12	V
FB1, 2 Pin Voltage	VFB	- 0.3 ~ 12	V
EN1, 2 Pin Voltage	VEN	- 0.3 ~ 12	V
PWM1,2 Pin Voltage	VPWM	- 0.3 ~ 12	V
EXT1, 2 Pin Voltage	VEXT	- 0.3 ~ VDD + 0.3	V
EXT1, 2 Pin Current	IEXT	± 100	mA
Power Dissipation	Pd	150	mW
Operating Ambient Temperature	Topr	- 40 ~ + 85	°C
Storage Temperature	Tstg	- 55 ~ + 125	°C

Electrical Characteristics XC9501B092A

Common Characteristics

(FOSC=180kHz)

Ta=25°C

PARAMETER	SYMBOL	CONDITIONS	MIN.	TYP.	MAX.	UNITS	TEST CIRCUIT
Supply Voltage (note 1)	VDD		2.0	-	10.0	V	
Output Voltage Range (note 4)	VOUTSET	VDD ≥ 2.0V, IOUT1, 2=1mA VOUT1, VOUT2	0.9	-	-	V	①
		VIN ≥ 0.9V, IOUT1, 2=1mA VOUT1 (note 2)	2.0	-	10.0	V	②
		VIN ≥ 0.9V, IOUT1, 2=1mA VOUT2 (note 3)	0.9	-	-	V	③
Supply Current 1	IDD1	FB1,2=0V	-	90	160	μA	④
Supply Current 1-1	IDD1-1	EN1=3.0V, EN2=0V, FB1=0V EN2=3.0V, EN1=0V, FB2=0V	-	60	120	μA	④
Supply Current 1-2	IDD1-2	FB1=0V, FB2=1.0V FB1=1.0V, FB2=0V	-	80	150	μA	④
Supply Current 2	IDD2	FB1,2=1.0V	-	70	132	μA	④
Stand-by Current	ISTB	Same as IDD1, EN1=EN2=0V	-	-	3.0	μA	④
Switching Frequency	FOSC	Same as IDD1	153	180	207	kHz	④
EN1,2 "High" Voltage	VENH	FB1,2=0V	0.65	-	-	V	④
EN1,2 "Low" Voltage	VENL	FB1,2=0V	-	-	0.20	V	④
EN1,2 "High" Current	IENH	FB1,2=3.0V	-	-	0.50	μA	④
EN1,2 "Low" Current	IENL	EN1,2=0V, FB1,2=3.0V	-	-	-0.50	μA	④
PWM1,2 "High" Current	IPWMH	FB1,2=3.0V, PWM=3.0V	-	-	0.50	μA	④
PWM1,2 "Low" Current	IPWML	FB1,2=3.0V, PWM=0V	-	-	-0.50	μA	④
FB1,2 "High" Current	IFBH	FB1,2=3.0V	-	-	0.50	μA	④
FB1,2 "Low" Current	VFBL	FB1,2=1V	-	-	-0.50	μA	④

Unless otherwise stated, VDD=3.0V, PWM1,2=3.0V, EN1, 2=3.0V

Output 1 Characteristics

Step-up Controller

Ta=25°C

PARAMETER	SYMBOL	CONDITIONS	MIN.	TYP.	MAX.	UNITS	TEST CIRCUIT
FB1 Voltage	VFB1	VDD=3.0V, VIN=1.5V, IOUT1=10mA	0.882	0.900	0.918	V	⑤
Operation Start-up Voltage1 (note 2)	VST1-1	Using Tr: 2SD1628, IOUT=1.0mA, RFB11=200kΩ, RFB12=75kΩ	-	-	0.9	V	②
		VDD ≠ VOUT1: IOUT1=1mA	-	-	2.0	V	①
Oscillation Start-up Voltage1	VST2-1	FB1=0V	-	-	0.8	V	④
Maximum Duty Ratio1	MAXDTY1	Same as IDD1	75	80	85	%	④
PFM Duty Ratio1	PFMDTY1	No Load, VPWM1=0V	22	30	38	%	⑥
Efficiency1	EFFI1	IOUT1=100mA Nch MOSFET:XP161A1355P	-	83	-	%	⑥
Soft-Start Time1	TSS1	VOUT1 × 0.95V, CE1=0V → 0.65V	5.0	10.0	20.0	mS	⑥
EXT1 "High" ON Resistance	REXTBH1	FB1=0, EXT1=VDD-0.4V	-	28	47	Ω	⑦
EXT1 "Low" ON Resistance	REXTBL1	EN1=FB2=0V, EXT1=0.4V	-	22	30	Ω	⑦
PWM1 "High" Voltage	VPWMH1	No Load	0.65	-	-	V	⑥
PWM1 "Low" Voltage	VPWML1	No Load	-	-	0.20	V	⑥

Unless otherwise stated, VDD=EN1=PWM1=3.0V, EN2=PWM2=GND, EXT2=OPEN, FB2=OPEN, VIN=1.8V

Output 2 Characteristics

Step-up Controller

Ta=25°C

PARAMETER	SYMBOL	CONDITIONS	MIN.	TYP.	MAX.	UNITS	TEST CIRCUIT
FB2 Voltage	VFB2	VDD=3.0V, VIN=1.5V, IOUT2=10mA	0.882	0.900	0.918	V	⑧
Operation Start-up Voltage2 (note 3)	VST1-2	Using Tr: 2SD1628, IOUT2=1.0mA, RFB21=200kΩ, RFB22=75kΩ	-	-	0.9	V	③
		VDD ≠ VOUT2 : IOUT2=1mA	-	-	2.0	V	①
Oscillation Start-up Voltage2	VST2-2	FB2=0V	-	-	0.8	V	④
Maximum Duty Ratio2	MAXDTY2	Same as IDD1	75	80	85	%	④
PFM Duty Ratio2	PFMDTY2	No Load, VPWM2=0V	22	25	38	%	⑨
Efficiency2	EFFI2	IOUT2=100mA, Nch MOSFET:XP161A1355P	-	83	-	%	⑨
Soft-Start Time2	TSS2	VOUT2 × 0.95V, EN2=0V → 0.65V	5.0	10.0	20.0	mS	⑨
EXT2 "High" ON Resistance	REXTBH2	FB2=0, EXT2=VDD-0.4V	-	28	47	Ω	⑦
EXT2 "Low" ON Resistance	REXTBL2	EN2=FB2=0V, EXT2=0.4V	-	22	30	Ω	⑦
PWM2 "High" Voltage	VPWMH2	No Load	0.65	-	-	V	⑨
PWM2 "Low" Voltage	VPWML2	No Load	-	-	0.20	V	⑨

Unless otherwise stated, VDD=EN2=PWM2=3.0V, PWM1=EN1=GND, EXT1=OPEN, FB1=OPEN, VIN=1.8V

Electrical Characteristics XC9501B093A

Common Characteristics

(FOSC=300kHz)

Ta=25°C

PARAMETER	SYMBOL	CONDITIONS	MIN.	TYP.	MAX.	UNITS	CIRCUIT
Supply Voltage (note 1)	VDD		2.0	-	10.0	V	
Output Voltage Range (note 4)	VOUTSET	VDD ≥ 2.0V, IOUT1, 2 = 1mA VOUT1, VOUT2	0.9	-	-	V	①
		VIN ≥ 0.9V, IOUT1, 2 = 1mA VOUT1	2.0	-	10.0	V	②
		(note 2) VOUT2	0.9	-	-	V	
		VIN ≥ 0.9V, IOUT1, 2 = 1mA (note 3) VOUT1	0.9	-	-	V	③
	VOUT2	2.0	-	10.0	V		
Supply Current 1	IDD1	FB1,2=0V	-	110	250	μA	④
Supply Current 1-1	IDD1-1	EN1=3.0V, EN2=0V, FB1=0V	-	80	150	μA	④
		EN2=3.0V, EN1=0V, FB2=0V					
Supply Current 1-2	IDD1-2	FB1=0V, FB2=1.0V	-	90	200	μA	④
		FB1=1.0V, FB2=0V					
Supply Current 2	IDD2	FB1,2=1.0V	-	80	160	μA	④
Stand-by Current	ISTB	Same as IDD1, EN1=EN2=0V	-	-	3.0	μA	④
Switching Frequency	FOSC	Same as IDD1	255	300	345	kHz	④
EN1,2 "High" Voltage	VENH	FB1,2=0V	0.65	-	-	V	④
EN1,2 "Low" Voltage	VENL	FB1,2=0V	-	-	0.20	V	④
EN1,2 "High" Current	IENH	FB1,2=3.0V	-	-	0.50	μA	④
EN1,2 "Low" Current	IENL	EN1,2=0V, FB1,2=3.0V	-	-	-0.50	μA	④
PWM1,2 "High" Current	IPWMH	FB1,2=3.0V, PWM=3.0V	-	-	0.50	μA	④
PWM1,2 "Low" Current	IPWML	FB1,2=3.0V, PWM=0V	-	-	-0.50	μA	④
FB1,2 "High" Current	IFBH	FB1,2=3.0V	-	-	0.50	μA	④
FB1,2 "Low" Current	VFBL	FB1,2=1V	-	-	-0.50	μA	④

Unless otherwise stated, VDD=3.0V, PWM1,2=3.0V, EN1, 2 =3.0V

Output 1 Characteristics

Step-up Controller

Ta=25°C

PARAMETER	SYMBOL	CONDITIONS	MIN.	TYP.	MAX.	UNITS	CIRCUIT
FB1 Voltage	VFB1	VDD=3.0V, VIN=1.5V, IOUT1=10mA	0.882	0.900	0.918	V	⑤
Operation Start-up Voltage1 (note 2)	VST1-1	Using Tr: 2SD1628, IOUT=1.0mA, RFB11=200kΩ, RFB12=75kΩ	-	-	0.9	V	②
		VDD ≠ VOUT1: IOUT1=1mA	-	-	2.0	V	①
Oscillation Start-up Voltage1	VST2-1	FB1=0V	-	-	0.8	V	④
Maximum Duty Ratio1	MAXDTY1	Same as IDD1	75	80	85	%	④
PFM Duty Ratio1	PFMDTY1	No Load, VPWM1=0V	22	30	38	%	⑥
Efficiency1	EFF1	IOUT1=100mA, Nch MOSFET:XP161A1355P	-	83	-	%	⑥
Soft-Start Time1	TSS1	VOUT1 × 0.95V, CE1=0V → 0.65V	5.0	10.0	20.0	mS	⑥
EXT1 "High" ON Resistance	REXTBH1	FB1=0, EXT1=VDD-0.4V	-	28	47	Ω	⑦
EXT1 "Low" ON Resistance	REXTBL1	EN1=FB2=0V, EXT1=0.4V	-	22	30	Ω	⑦
PWM1 "High" Voltage	VPWMH1	No Load	0.65	-	-	V	⑥
PWM1 "Low" Voltage	VPWML1	No Load	-	-	0.20	V	⑥

Unless otherwise stated, VDD=EN1=PWM1=3.0V, EN2=PWM2=GND, EXT2=OPEN, FB2=OPEN, VIN=1.8V

Output 2 Characteristics

Step-up Controller

Ta=25°C

PARAMETER	SYMBOL	CONDITIONS	MIN.	TYP.	MAX.	UNITS	CIRCUIT
FB2 Voltage	VFB2	VDD=3.0V, VIN=1.5V, IOUT2=10mA	0.882	0.900	0.918	V	⑧
Operation Start-up Voltage2 (note 3)	VST1-2	Using Tr: 2SD1628, IOUT2=1.0mA, RFB21=200kΩ, RFB22=75kΩ	-	-	0.9	V	③
		VDD ≠ VOUT2 : IOUT2=1mA	-	-	2.0	V	①
Oscillation Start-up Voltage2	VST2-2	FB2=0V	-	-	0.8	V	④
Maximum Duty Ratio2	MAXDTY2	Same as IDD1	75	80	85	%	④
PFM Duty Ratio2	PFMDTY2	No Load, VPWM2=0V	22	30	38	%	⑨
Efficiency2	EFFI2	IOUT2=100mA, Nch MOSFET:XP161A1355P	-	83	-	%	⑨
Soft-Start Time2	TSS2	VOUT2 × 0.95V, EN2=0V → 0.65V	5.0	10.0	20.0	mS	⑨
EXT2 "High" ON Resistance	REXTBH2	FB2=0, EXT2=VDD-0.4V	-	28	47	Ω	⑦
EXT2 "Low" ON Resistance	REXTBL2	EN2=FB2=0V, EXT2=0.4V	-	22	30	Ω	⑦
PWM2 "High" Voltage	VPWMH2	No Load	0.65	-	-	V	⑨
PWM2 "Low" Voltage	VPWML2	No Load	-	-	0.20	V	⑨

Unless otherwise stated, VDD=EN2=PWM2=3.0V, PWM1=EN1=GND, EXT1=OPEN, FB1=OPEN, VIN=1.8V

Electrical Characteristics XC9501B095A

Common Characteristics

(FOSC=500kHz)

Ta=25°C

PARAMETER	SYMBOL	CONDITIONS	MIN.	TYP.	MAX.	UNITS	CIRCUIT
Supply Voltage (note 1)	VDD		2.0	-	10.0	V	
Output Voltage Range (note 4)	VOUTSET	VDD ≥ 2.0V, IOUT1, 2 = 1mA VOUT1, VOUT2	0.9	-	-	V	①
		VIN ≥ 0.9V, IOUT1, 2 = 1mA VOUT1 (note 2)	2.0	-	10.0	V	②
		VIN ≥ 0.9V, IOUT1, 2 = 1mA VOUT2 (note 2)	0.9	-	-	V	②
		VIN ≥ 0.9V, IOUT1, 2 = 1mA VOUT1 (note 3)	0.9	-	-	V	③
		VOUT2 (note 3)	2.0	-	10.0	V	③
Supply Current 1	IDD1	FB1,2=0V	-	165	350	μA	④
Supply Current 1-1	IDD1-1	EN1=3.0V, EN2=0V, FB1=0V EN2=3.0V, EN1=0V, FB2=0V	-	110	220	μA	④
Supply Current 1-2	IDD1-2	FB1=0V, FB2=1.0V FB1=1.0V, FB2=0V	-	130	270	μA	④
Supply Current 2	IDD2	FB1,2=1.0V	-	100	200	μA	④
Stand-by Current	ISTB	Same as IDD1, EN1=EN2=0V	-	-	3.0	μA	④
Switching Frequency	FOSC	Same as IDD1	425	500	575	kHz	④
EN1,2 "High" Voltage	VENH	FB1,2=0V	0.65	-	-	V	④
EN1,2 "Low" Voltage	VENL	FB1,2=0V	-	-	0.20	V	④
EN1,2 "High" Current	IENH	FB1,2=3.0V	-	-	0.50	μA	④
EN1,2 "Low" Current	IENL	EN1,2=0V, FB1,2=3.0V	-	-	-0.50	μA	④
PWM1,2 "High" Current	IPWMH	FB1,2=3.0V, PWM=3.0V	-	-	0.50	μA	④
PWM1,2 "Low" Current	IPWML	FB1,2=3.0V, PWM=0V	-	-	-0.50	μA	④
FB1,2 "High" Current	IFBH	FB1,2=3.0V	-	-	0.50	μA	④
FB1,2 "Low" Current	VFBL	FB1,2=1V	-	-	-0.50	μA	④

Unless otherwise stated, VDD=3.0V, PWM1,2=3.0V, EN1, 2 =3.0V

Output 1 Characteristics

Step-up Controller

Ta=25°C

PARAMETER	SYMBOL	CONDITIONS	MIN.	TYP.	MAX.	UNITS	CIRCUIT
FB1 Voltage	VFB1	VDD=3.0V, VIN=1.5V, IOUT1=10mA	0.882	0.900	0.918	V	⑤
Operation Start-up Voltage1 (note 2)	VST1-1	Using Tr: 2SD1628, IOUT=1.0mA, RFB11=200kΩ, RFB12=75kΩ	-	-	0.9	V	②
		VDD ≠ VOUT1: IOUT1=1mA	-	-	2.0	V	①
Oscillation Start-up Voltage1	VST2-1	FB1=0V	-	-	0.8	V	④
Maximum Duty Ratio1	MAXDTY1	Same as IDD1	75	80	85	%	④
PFM Duty Ratio1	PFMDTY1	No Load, VPWM1=0V	22	30	38	%	⑥
Efficiency1	EFFI1	IOUT1=100mA, Nch MOSFET:XP161A1355P	-	83	-	%	⑥
Soft-Start Time1	TSS1	VOUT1 × 0.95V, CE1=0V → 0.65V	5.0	10.0	20.0	mS	⑥
EXT1 "High" ON Resistance	REXTBH1	FB1=0, EXT1=VDD-0.4V	-	28	47	Ω	⑦
EXT1 "Low" ON Resistance	REXTBL1	EN1=FB2=0V, EXT1=0.4V	-	22	30	Ω	⑦
PWM1 "High" Voltage	VPWMH1	No Load	0.65	-	-	V	⑥
PWM1 "Low" Voltage	VPWML1	No Load	-	-	0.20	V	⑥

Unless otherwise stated, VDD=EN1=PWM1=3.0V, EN2=PWM2=GND, EXT2=OPEN, FB2=OPEN, VIN=1.8V

Output 2 Characteristics

Step-up Controller

Ta=25°C

PARAMETER	SYMBOL	CONDITIONS	MIN.	TYP.	MAX.	UNITS	CIRCUIT
FB2 Voltage	VFB2	VDD=3.0V, VIN=1.5V, IOUT2=10mA	0.882	0.900	0.918	V	⑧
Operation Start-up Voltage2 (note 3)	VST1-2	Using Tr: 2SD1628, IOUT2=1.0mA, RFB21=200kΩ, RFB22=75kΩ	-	-	0.9	V	③
		VDD ≠ VOUT2 : IOUT2=1mA	-	-	2.0	V	①
Oscillation Start-up Voltage2	VST2-2	FB2=0V	-	-	0.8	V	④
Maximum Duty Ratio2	MAXDTY2	Same as IDD1	75	80	85	%	④
PFM Duty Ratio2	PFMDTY2	No Load, VPWM2=0V	22	30	38	%	⑨
Efficiency2	EFFI2	IOUT2=100mA, Nch MOSFET:XP161A1355P	-	83	-	%	⑨
Soft-Start Time2	TSS2	VOUT2 × 0.95V, EN2=0V → 0.65V	5.0	10.0	20.0	mS	⑨
EXT2 "High" ON Resistance	REXTBH2	FB2=0, EXT2=VDD-0.4V	-	28	47	Ω	⑦
EXT2 "Low" ON Resistance	REXTBL2	EN2=FB2=0V, EXT2=0.4V	-	22	30	Ω	⑦
PWM2 "High" Voltage	VPWMH2	No Load	0.65	-	-	V	⑨
PWM2 "Low" Voltage	VPWML2	No Load	-	-	0.20	V	⑨

Unless otherwise stated, VDD=EN2=PWM2=3.0V, PWM1=EN1=GND, EXT1=OPEN, FB1=OPEN, VIN=1.8V

Notes

- 1) Although the IC's step-up operations start from a VDD of 0.8V, the output voltage and switching frequency are stabilized at VDD ≥ 2.0V. Therefore, a VDD of more than 2.0V is recommended when VDD is supplied from VIN or other power sources.
- 2) Although the IC's switching operations start from a VIN of 0.9V, the IC's power supply pin (VDD) and output voltage monitor pin (FB1) should be connected to VOUT1. With operations from VIN=0.9V, the 2nd channel's (output 2) EN2 pin should be set to disable. Once output voltage VOUT1 is more than 2.0V, the EN2 pin should be set to enable.
- 3) Although the IC's switching operations start from a VIN of 0.9V, the IC's power supply pin (VDD) and output voltage monitor pin (FB2) should be connected to VOUT2. With operations from VIN=0.9V, the 1st channel's (output 1) EN1 pin should be set to disable. Once output voltage VOUT2 is more than 2.0V, the EN1 pin should be set to enable.
- 4) Please be careful not to exceed the breakdown voltage level of the peripheral parts.
- 5) $EFFI = \left\{ \frac{(\text{Output voltage}) \times (\text{Output current})}{(\text{Input voltage}) \times (\text{Input Current})} \right\} \times 100$

■ Typical Application Circuit

① VDD connected to VOUT1

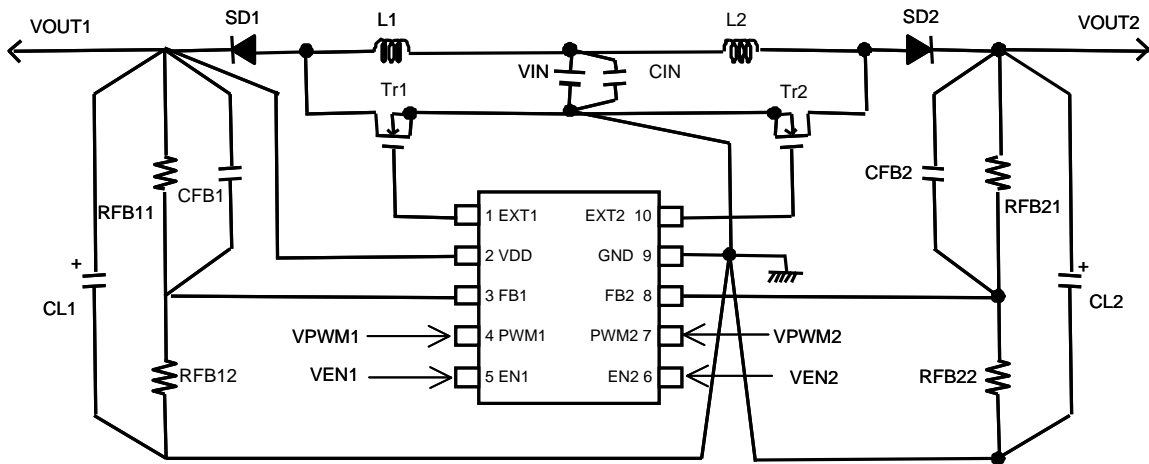

② VDD connected to VIN

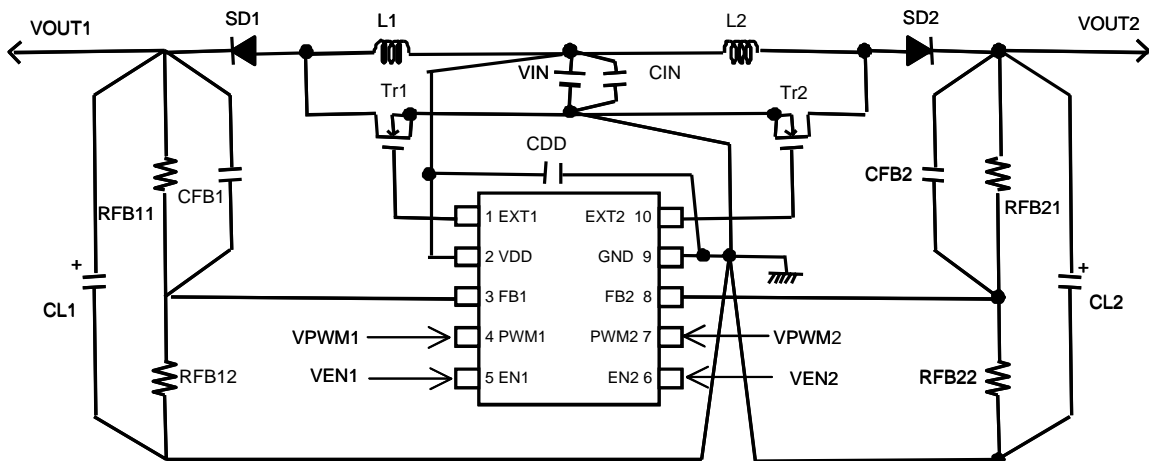

■ Operation Description

The XC9501 series are multi-functional, 2 channel step-up DC/DC converter controller ICs with built-in high speed, low ON resistance drivers.

<Error Amp>

The Error Amplifier is designed to monitor the output voltage and it compares the feedback voltage (FB) with the reference voltage. In response to feedback of a voltage lower than the reference voltage, the output voltage of the error amp. decreases.

<OSC Generator>

This circuit generates the Switching Frequency which in turn generates the reference clock.

<Ramp Wave Generator 1, 2>

The Ramp Wave Generator generates a saw-tooth waveform based on outputs from the Phase Shift Generator.

<PWM Comparator 1, 2>

The PWM Comparator compares outputs from the Error Amp. and saw-tooth waveform. When the voltage from the Error Amp's output is low, the external switch will be set to ON.

<PWM/PFM Controller 1, 2>

This circuit generates PFM pulses.

Control can be switched between PWM control and PWM/PFM automatic switching control using external signals.

The PWM/PFM automatic switching mode is selected when the voltage of the PWM1 (2) pin is less than 0.2V, and the control switches between PWM and PFM automatically depending on the load. As the PFM circuit generates pulses based on outputs from the PWM comparator, shifting between modes occurs smoothly. PWM control mode is selected when the voltage of the PWM1 (2) pin is more than 0.65V. Noise is easily reduced with PWM control since the switching frequency is fixed.

Control suited to the application can easily be selected which is useful in audio applications, for example, where traditionally, efficiencies have been sacrificed during stand-by as a result of using PWM control (due to the noise problems associated with the PFM mode in stand-by).

<Vref with Soft Start 1, 2>

The reference voltage, Vref (FB pin voltage)=0.9V, is adjusted and fixed by laser trimming (for output voltage settings, please refer to the notes on page 8). To protect against inrush current, when the power is switched on, and also to protect against voltage overshoot, soft-start time is set internally to 10ms. It should be noted, however, that this circuit does not protect the load capacitor (CL) from inrush current. With the Vref voltage limited and depending upon the input to the error amps, the operation maintains a balance between the two inputs of the error amps and controls the EXT pin's ON time so that it doesn't increase more than is necessary.

<Enable Function>

This function controls the operation and shutdown of the IC. When the voltage of the EN1 or EN2 pins is 0.2V or less, the mode will be disable, the channel's operations will stop and the EXT1 pin will be kept at a low level (the external N-type MOSFET will be OFF). When both EN1 and EN2 are in a state of disable, current consumption will be no more than 3.0 μ A.

When the EN1 or EN2 pin's voltage is 0.65V or more, the mode will be enable and operations will recommence. With soft-start, 95% of the set output voltage will be reached within 10mS (TYP) from the moment of enable.

The start-up sequence for EN1 and EN2 is required when operations begin with a power supply voltage of VDD<2.0V or less. Although IC starts oscillation from a VIN of 0.9V, the IC's power supply pin (VDD) and the output voltage monitor pin (FB1) should be connected to VOUT1. When the IC starts operations from a VIN of 0.9V, set channel two's (output 2) EN2 pin to disable and turn it to enable when VOUT1 is more than 2.0V. Conversely, when IC 2's power supply pin (VDD) and output voltage monitor

pin (FB2) are connected to VOUT2, set channel one's (output 1) EN1 pin to disable and turn it to enable when VOUT2 is more than 2.0V.

For power supply voltages of VDD<2.0V, oscillation may occur irrespective of the FB pin voltage. Should this happen, you may find that output voltage will be higher than the set voltage. The FB pin voltage and the reference voltage Vref will be compared and output voltage will be controlled when the power supply voltage is VDD>2.0V or more. With power supply voltages of VDD>2.0V, the start-up sequence for EN1 and EN2 will not be required.

<Setting of Output Voltage>

Output voltage can be set by adding external split resistors. Output voltage is determined by the following equation, based on the values of RFB11(RFB21) and RFB12(RFB22). The sum of RFB11(RFB21) and RFB12(RFB22) should normally be 1 MΩ or less.

$$V_{OUT} = 0.9 \times (R_{FB11} + R_{FB12}) / R_{FB12}$$

The value of CFB1(CFB2), speed-up capacitor for phase compensation, should be resulted $f_{zfb} = 1 / (2 \pi \times C_{FB1} \times R_{FB11})$ equal to 12kHz. Adjustments are required from 1kHz to 50kHz depending on the application, value of inductance (L), and value of load capacity (CL).

[Example of Calculation]

When RFB11=200kΩ and RFB12=75kΩ, $V_{OUT1} = 0.9 \times (200K + 75k) / 75k = 3.3V$.

[Typical Example]

VOUT (V)	RFB11 (kΩ)	RFB12 (kΩ)	CFB1 (pF)	VOUT (V)	RFB11 (kΩ)	RFB12 (kΩ)	CFB1 (pF)	VOUT (V)	RFB11 (kΩ)	RFB12 (kΩ)	CFB1 (pF)
1.5	220	330	62	2.7	360	180	33	12.0	160	13	82
1.8	220	220	62	3.0	560	240	24				
2.0	330	270	39	3.3	200	75	62				
2.2	390	270	33	5.0	82	18	160				
2.5	390	220	33	8.0	120	15	100				

The same method can be adopted for channel two (output 2) also.

[External Components]

Tr : * MOSFET

XP161A1355PR (TOREX N-Channel Power MOSFET)

Note : VGS Breakdown Voltage of this Tr. is 8V so please be careful with the power supply voltage. If the power supply voltage is more than 6V, please use XP161A1265PR, where VGS Breakdown Voltage is 12V. VST1 of XP161A1355PR is 1.2V (max.) and that of XP161A1265PR is 1.5V (max.)

* NPN MOSFET

2SD1628 (SANYO)

Rb : 500Ω

(Adjust in accordance with load & Tr.'s HFE.)

Cb : 2200pF (Ceramic)

Set up according to the equation below.

$$C_b \leq 1 / (2 \pi \times R_b \times F_{osc} \times 0.7)$$

SD : MA2Q737 (Schottky , MATSUSHITA)

CMS02 (Schottky , TOSHIBA)

L : 22μH (SUMIDA, CDRH5D28, FOSC = 180kHz)

15μH (SUMIDA, CDRH5D28, FOSC = 300kHz)

10μH (SUMIDA, CDRH5D28, FOSC = 500kHz)

CL : 16V, 47μF (Tantalum, NICHICHEMI MCE series)

Increase capacity according to the equation below when the step-up voltage ratio is large and output current is high.

$$CL = (CL \text{ standard value}) \times (I_{OUT} \text{ (mA)} / 300\text{mA}) \times V_{OUT} / V_{IN}$$

■ Test Circuit

Circuit 1

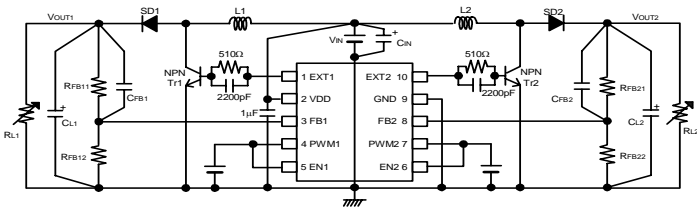

Circuit 6

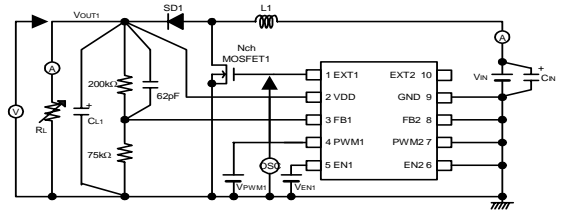

Circuit 2

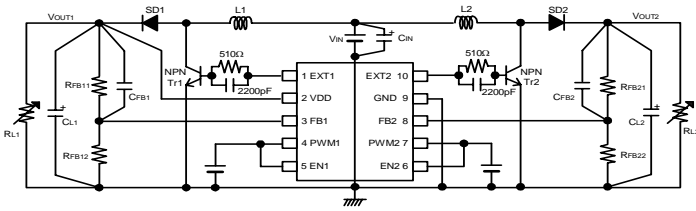

Circuit 7

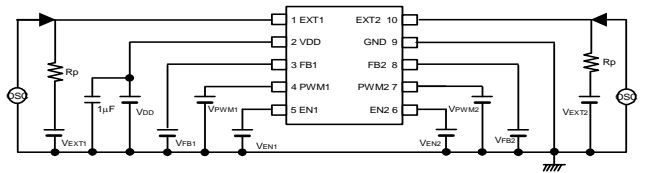

Circuit 3

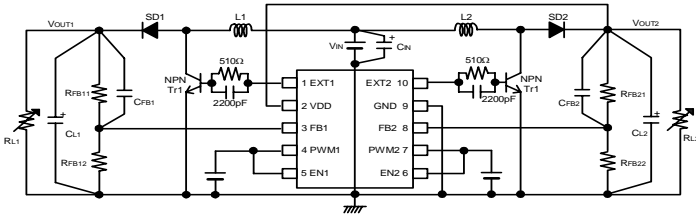

Circuit 8

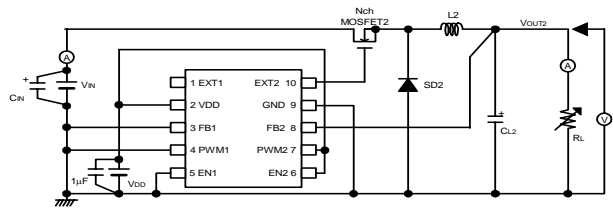

Circuit 4

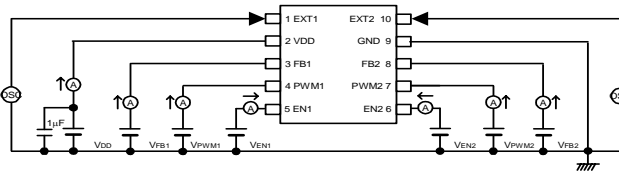

Circuit 9

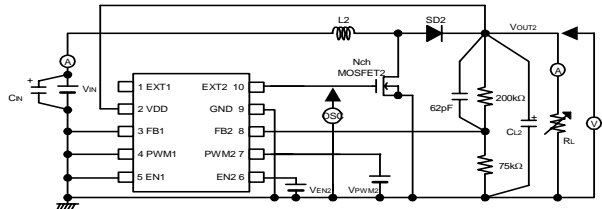

Circuit 5

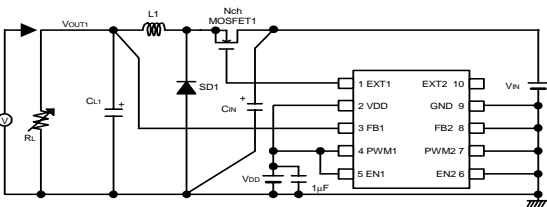

■ Peripheral Components Used for Test Circuits

Circuit 1, Circuit 2, Circuit 3

L1, L2 :	22 μ H (SUMIDA CDRH5D28) : XC9501B092A
	15 μ H (SUMIDA CDRH5D28) : XC9501B093A
	10 μ H (SUMIDA CDRH5D28) : XC9501B095A
SD1, SD2 :	CRS02 (Schottky diode, TOSHIBA)
	EC10QS06 (Schottky diode, NIHON INTER)
CL1, CL2 :	16MCE476MD2 (Tantalum, NIHON CHEMICON)
	35MCE335MB2 (Tantalum, NIHON CHEMICON)
CIN :	16MCE476MD2 (Tantalum, NIHON CHEMICON)
NPN Tr1, 2:	2SA1628 (SANYO)
	CPH3215 (SANYO)
	CPH3210 (SANYO)
RFB :	Please use by the conditions as below.
	$RFB11 + RFB12 \leq 1M\Omega$
	$RFB21 + RFB22 \leq 1M\Omega$
	$RFB11 / RFB12 = (\text{Setting Output Voltage} / 0.9) - 1$
	$RFB21 / RFB22 = (\text{Setting Output Voltage} / 0.9) - 1$
CFB :	Please adjust as below:
	$f_{zfb} = 1 / (2 \times \pi \times CFB1 \times RFB11) = 1\text{kHz} \sim 50\text{kHz} (12\text{kHz usual})$
	$f_{zfb} = 1 / (2 \times \pi \times CFB2 \times RFB21) = 1\text{kHz} \sim 50\text{kHz} (12\text{kHz usual})$

Circuit 6 and Circuit 9

L1, L2 :	22 μ H (SUMIDA CDRH5D28) : XC9501B092A
	15 μ H (SUMIDA CDRH5D28) : XC9501B093A
	10 μ H (SUMIDA CDRH5D28) : XC9501B095A
SD1, SD2:	MA2Q737 (Schottky diode, MATSUSHITA)
CL1, CL2 :	16MCE476MD2 (Tantalum, NIHON CHEMICON)
CIN :	16MCE476MD2 (Tantalum, NIHON CHEMICON)
N-ch MOSFET1 :	XP161A1355P (TOREX)

Circuit 5 and Circuit 8

L1, L2 :	22 μ H (SUMIDA CDRH5D28)
SD1, SD2 :	MA2Q737 (Schottky, MATSUSHITA)
CL1, CL2 :	16MCE476MD2 (Tantalum, NIHON CHEMICON)
CIN :	16MCE476MD2 (Tantalum, NIHON CHEMICON)
N-ch MOSFET1 :	XP161A1355P (TOREX)

■ Notes on Use**1. PWM/PFM Automatic Switching**

If PWM/PFM automatic switching control is selected and the step-up ratio is low (e.g., from 4.5 V to 5.0 V), the control mode remains in PFM setting over the whole load range, since the duty ratio under continuous-duty condition is smaller than the PFM duty ratio of the XC9501 series. The output voltage's ripple voltage becomes substantially high under heavy load conditions, with the XC9501 series appearing to be producing an abnormal oscillation. If this operation becomes a concern, set pins PWM to High to set the control mode to PWM setting. For use under the above-mentioned condition, measured data of PWM/PFM automatic switching control shown on the data sheets are available up to $I_{OUT} = 100 \text{ mA}$.

3. Ratings

Use the XC9501 series and peripheral components within the limits of their ratings.

Typical Performance Characteristics

(1) Output Voltage vs. Output Current

FOSC=180kHz, V_{OUT1,2}= 1.5V

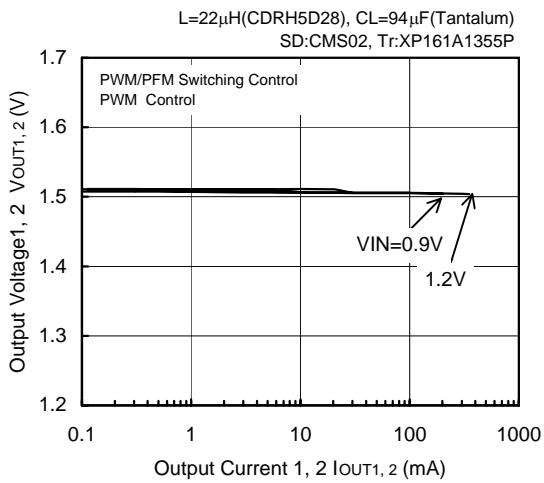

FOSC=180kHz, V_{OUT1,2}= 2.5V

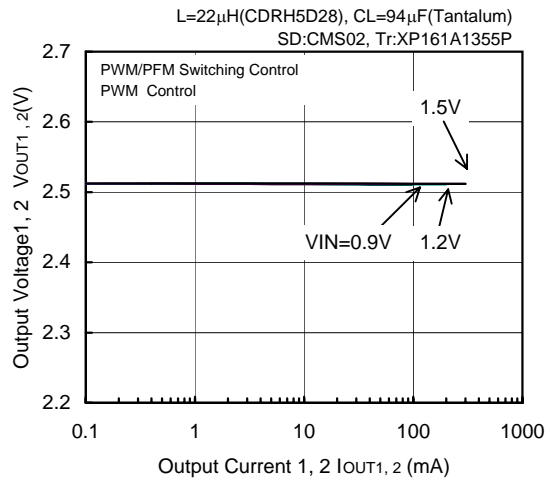

FOSC=180kHz, V_{OUT1,2}= 3.3V

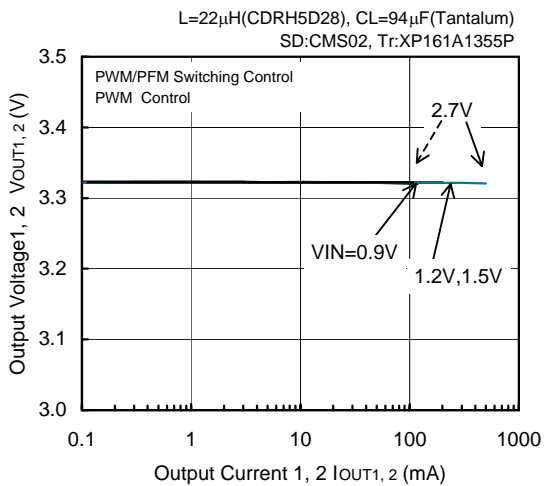

FOSC=180kHz, V_{OUT1,2}= 5.0V

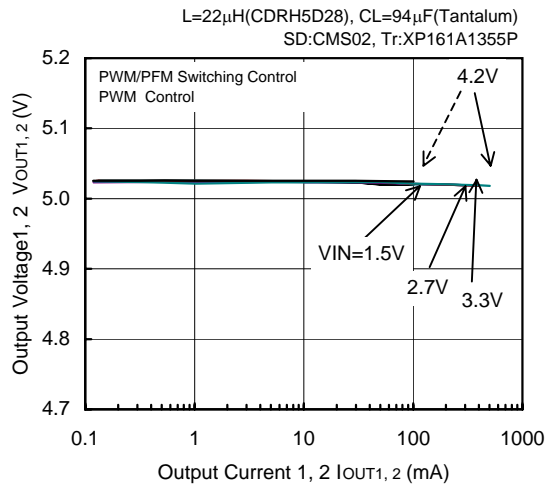

FOSC=180kHz, V_{OUT1,2}= 8.0V

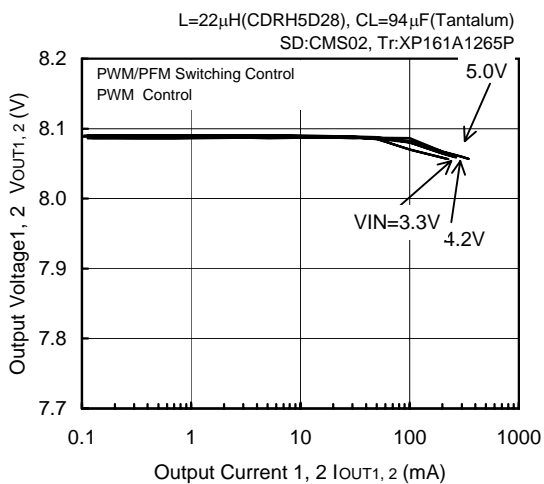

Dotted Arrowhead ----> PWM/PFM Switching Control

(1) Output Voltage vs. Output Current (Continued)

FOSC=300kHz, V_{OUT1,2} = 2.5V

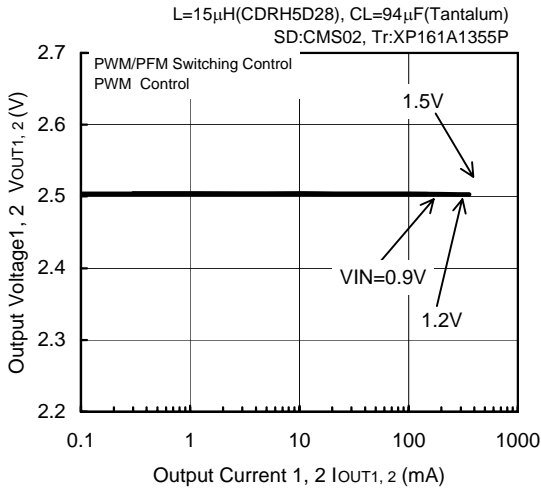

FOSC=300kHz, V_{OUT1,2} = 3.3V

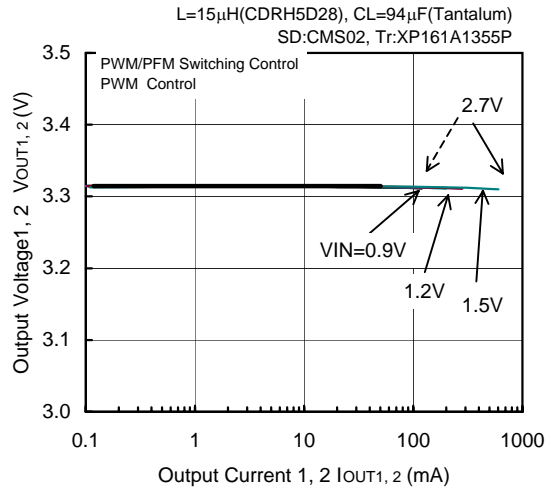

FOSC=300kHz, V_{OUT1,2} = 5.0V

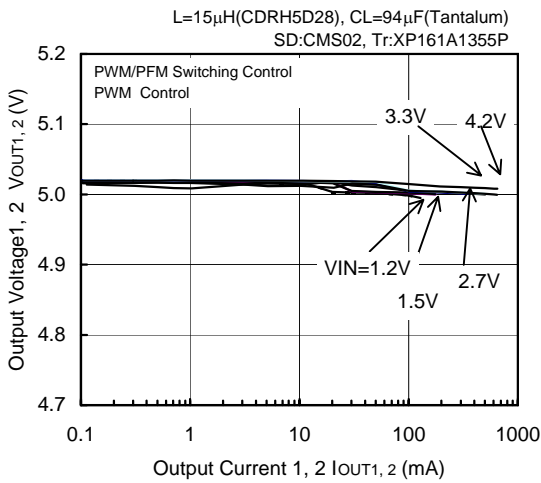

FOSC=500kHz, V_{OUT1,2} = 2.5V

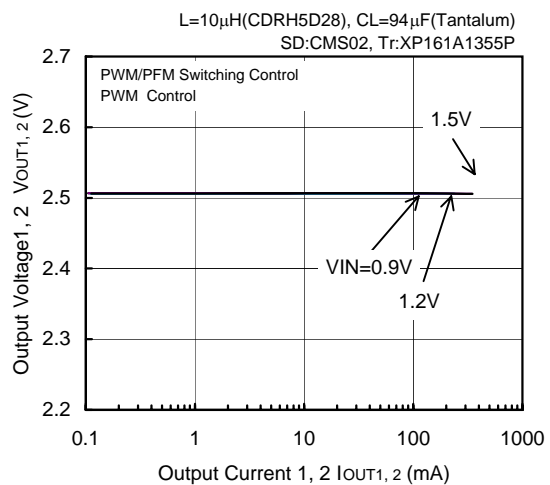

FOSC=500kHz, V_{OUT1,2} = 3.3V

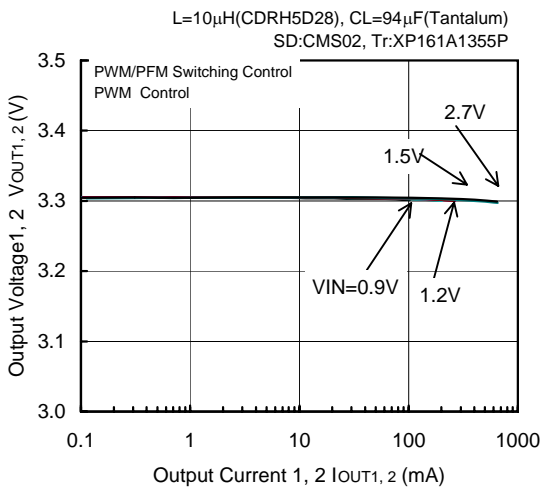

FOSC=500kHz, V_{OUT1,2} = 5.0V

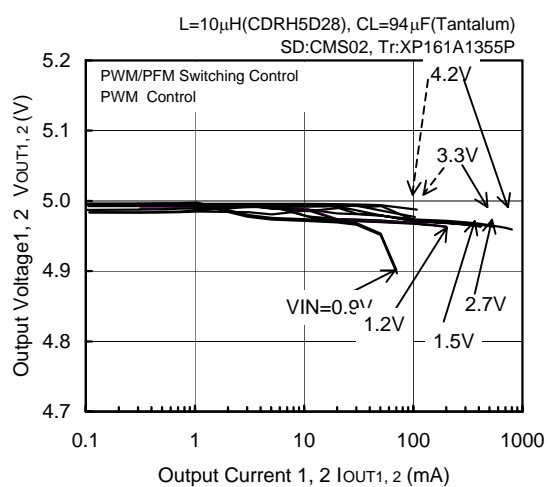

Dotted Arrowhead ----> PWM/PFM Switching Control

(2) Efficiency vs. Output Current

FOSC=180kHz, VOUT1, 2= 1.5V

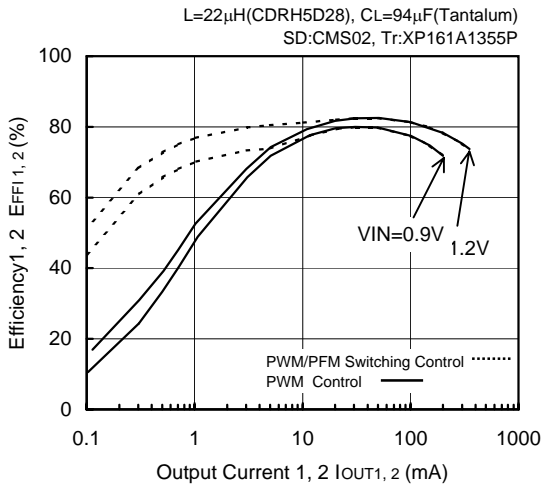

FOSC=180kHz, VOUT1, 2= 2.5V

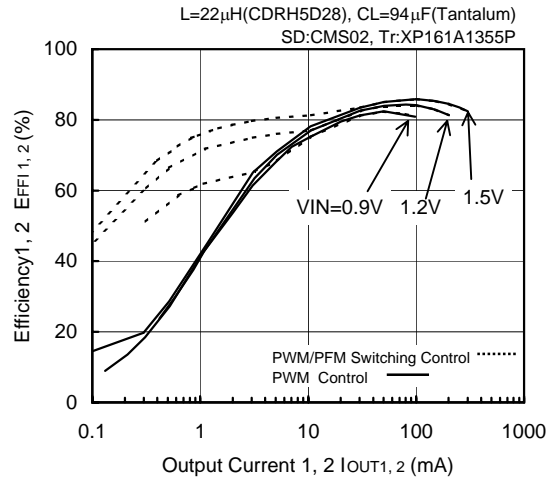

FOSC=180kHz, VOUT1, 2= 3.3V

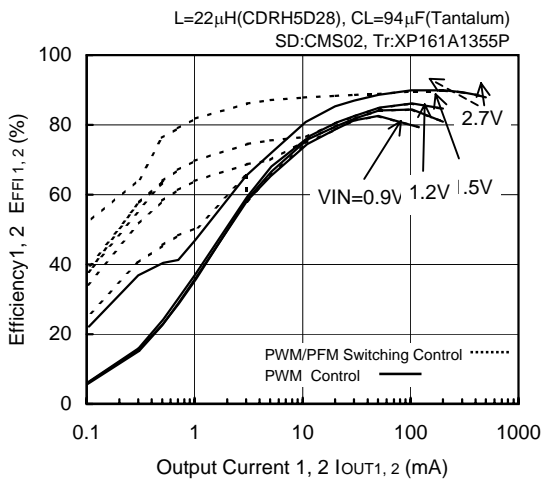

FOSC=180kHz, VOUT1, 2= 5.0V

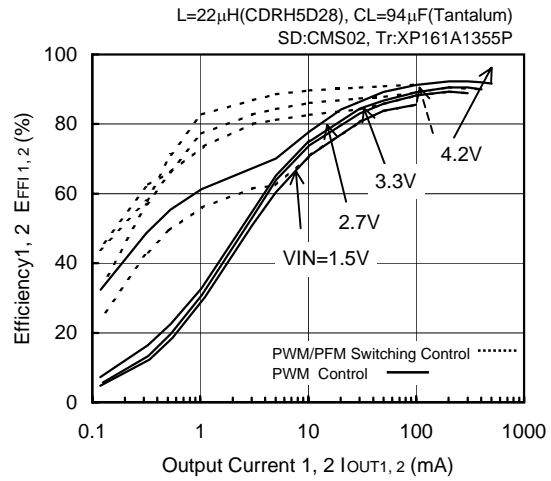

FOSC=180kHz, VOUT1, 2= 8.0V

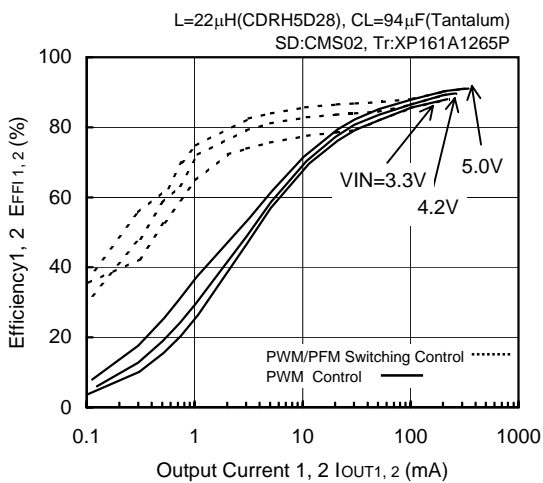

Dotted Arrowhead -----> PWM/PFM Switching Control

(2) Efficiency vs. Output Current (Continued)

FOSC=300kHz, VOUT1, 2= 2.5V

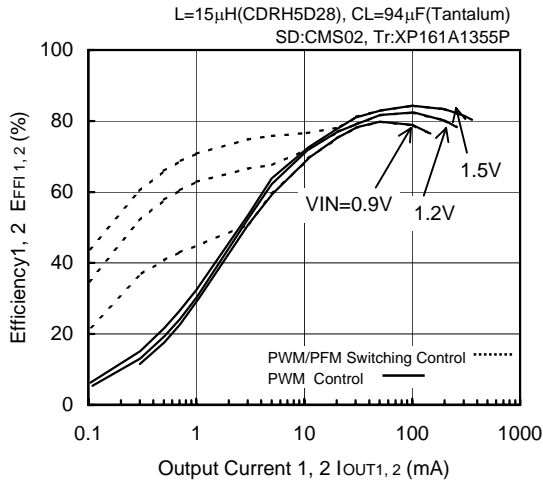

FOSC=300kHz, VOUT1, 2= 3.3V

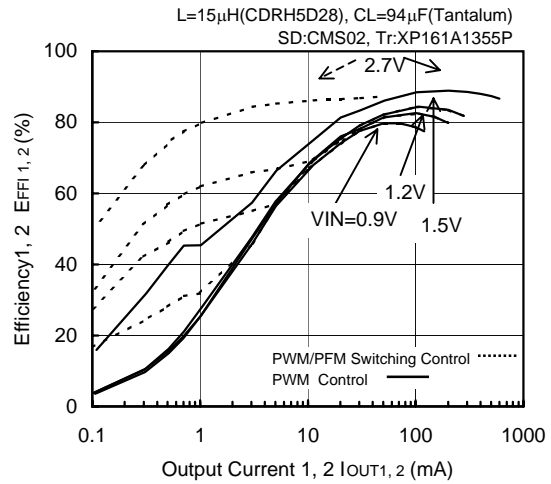

FOSC=300kHz, VOUT1, 2= 5.0V

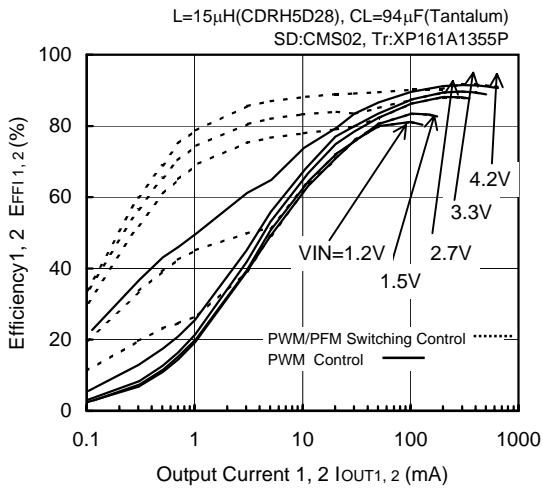

FOSC=500kHz, VOUT1, 2= 2.5V

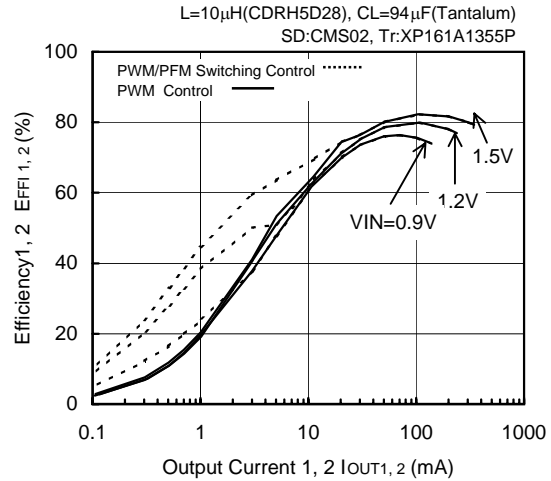

FOSC=500kHz, VOUT1, 2= 3.3V

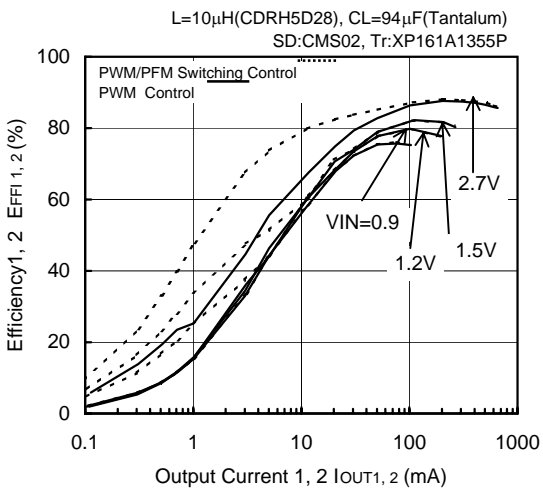

FOSC=500kHz, VOUT1, 2= 5.0V

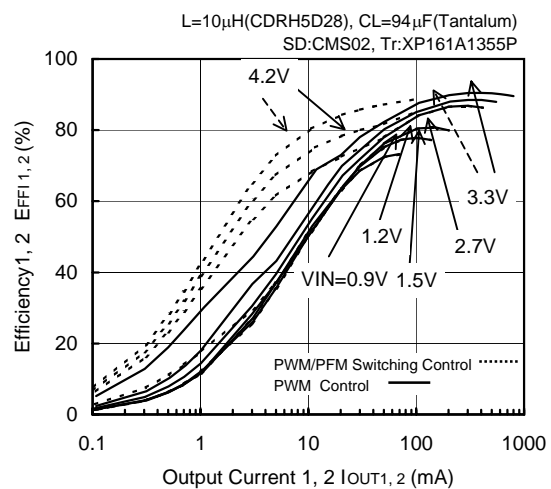

Dotted Arrowhead -----> PWM/PFM Switching Control

(3) Ripple Voltage vs. Output Current

FOSC=180kHz, V_{OUT1, 2}= 1.5V

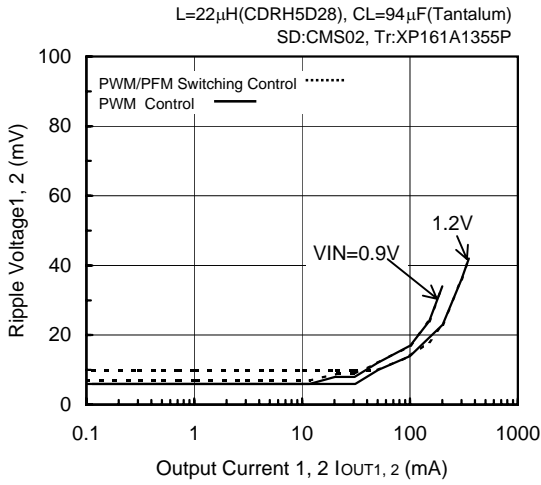

FOSC=180kHz, V_{OUT1, 2}= 2.5V

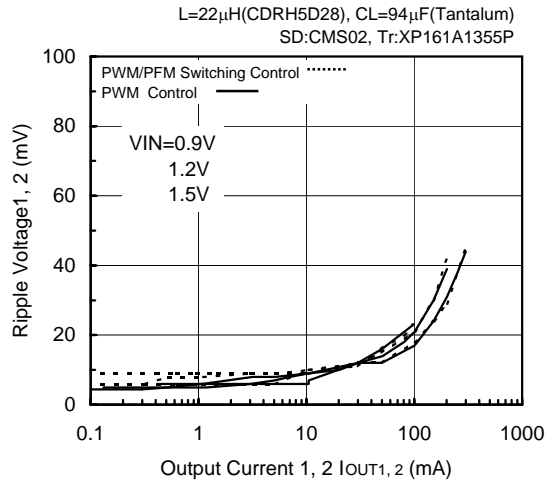

FOSC=180kHz, V_{OUT1, 2}= 3.3V

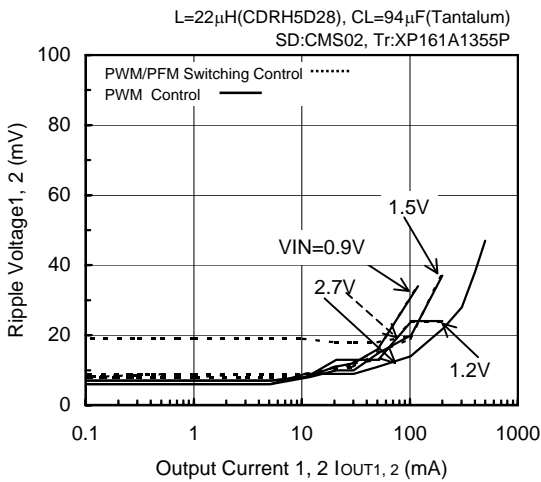

FOSC=180kHz, V_{OUT1, 2}= 5.0V

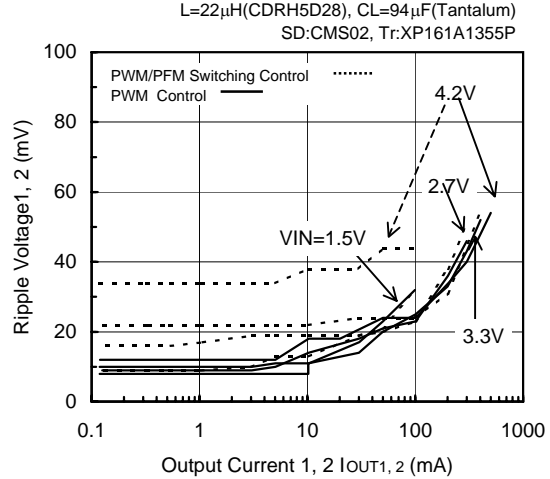

FOSC=180kHz, V_{OUT1, 2}= 8.0V

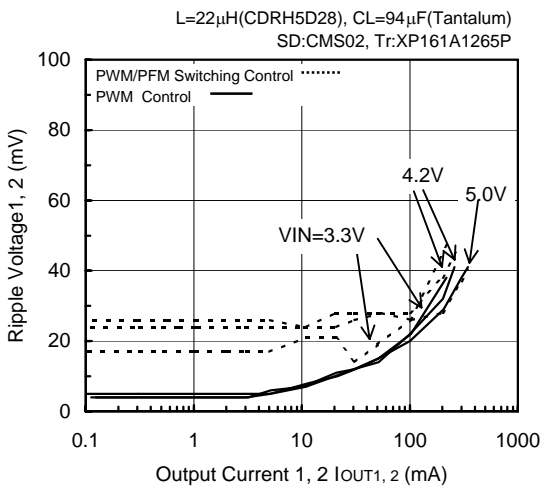

Dotted Arrowhead -----> PWM/PFM Switching Control

(3) Ripple Voltage vs. Output Current (Continued)

FOSC=300kHz, VOUT1, 2= 2.5V

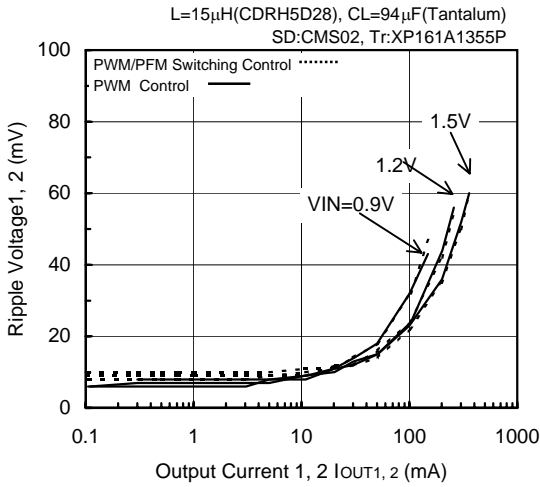

FOSC=300kHz, VOUT1, 2= 3.3V

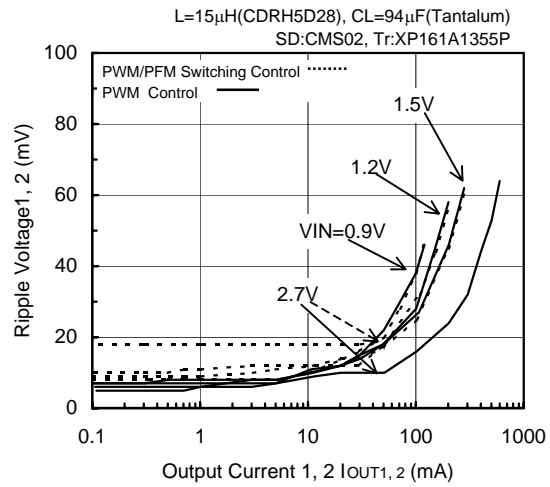

FOSC=300kHz, VOUT1, 2= 5.0V

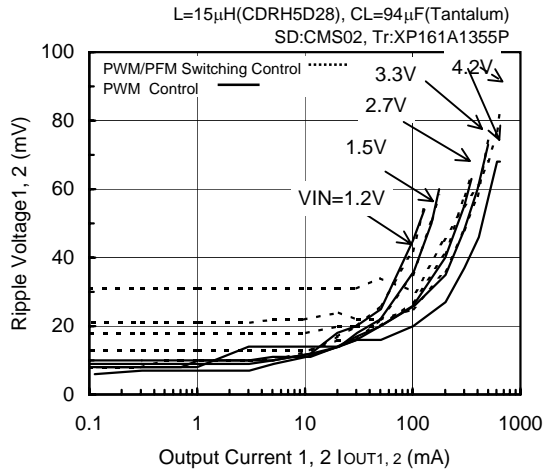

FOSC=500kHz, VOUT1, 2= 2.5V

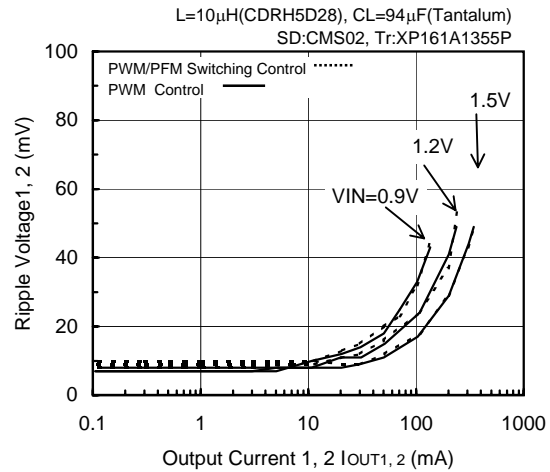

FOSC=500kHz, VOUT1, 2= 3.3V

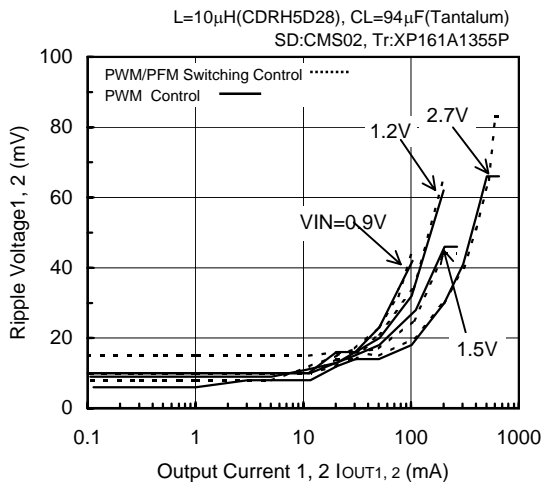

FOSC=500kHz, VOUT1, 2= 5.0V

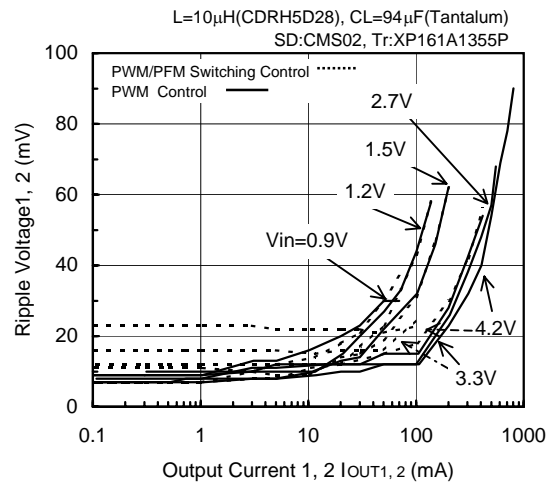

Dotted Arrowhead -----> PWM/PFM Switching Control

■ Typical Performance Characteristics (Continued)

(4) Supply Current vs. Supply Voltage

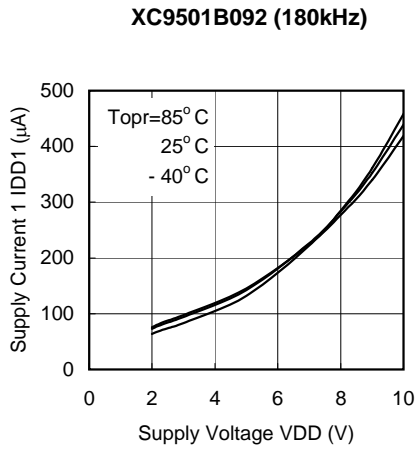

(5) Supply Current 1-1 vs. Supply Voltage

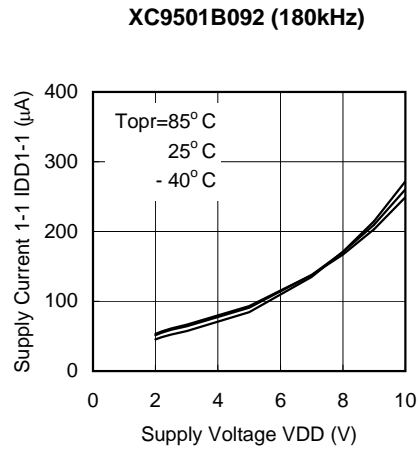

(6) Supply Current 1-2 vs. Supply Voltage

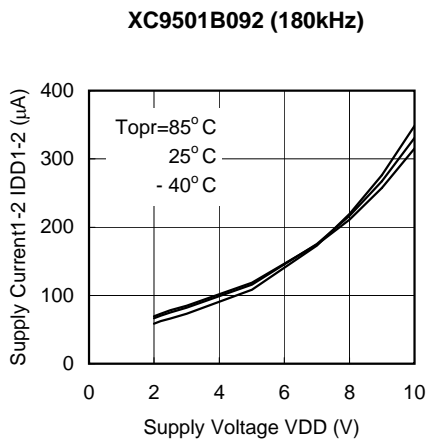

(7) Supply Current 2 vs. Supply Voltage

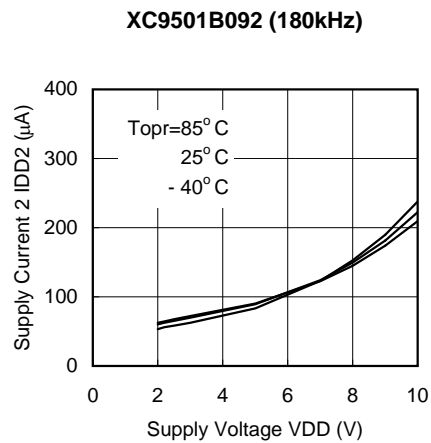

(8) Stand-by Current vs. Supply Voltage

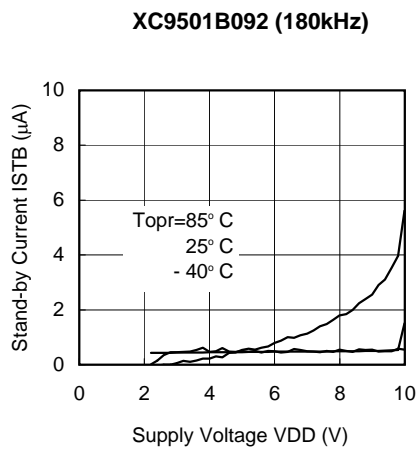

(9) Oscillation Frequency vs. Supply Voltage

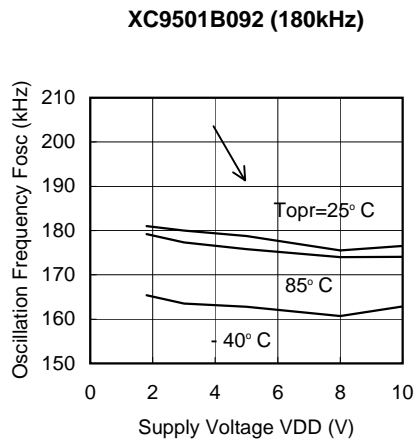

(10) PWM1, 2 'H' 'L' Voltage vs. Supply Voltage

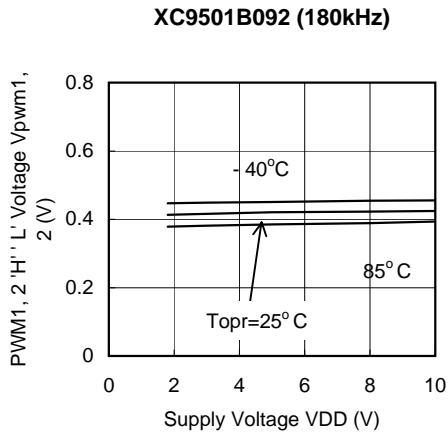

(11) EN1, 2 'H' 'L' Voltage vs. Supply Voltage

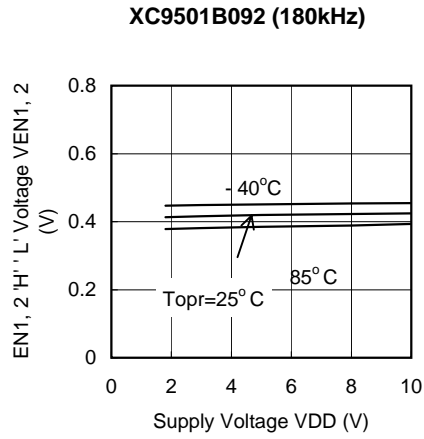

(12) Maximum Duty Ratio1, 2 vs. Supply Voltage

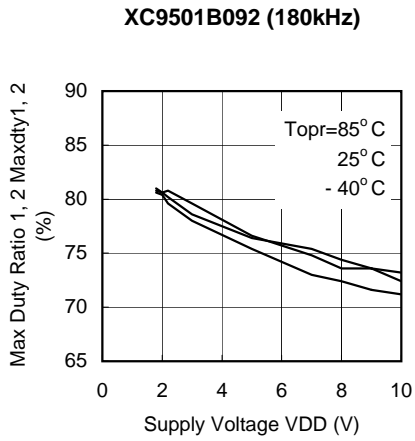

(13) Softstart Time1, 3 vs. Supply Voltage

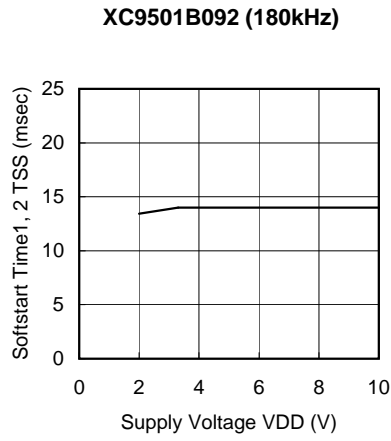

(14) EXT1, 2 High ON Resistance vs. Supply Voltage

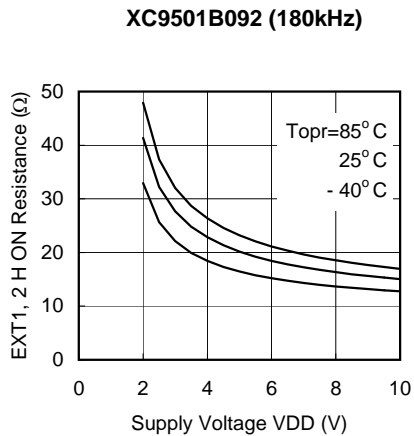

(15) EXT1, 2 Low ON Resistance vs. Supply Voltage

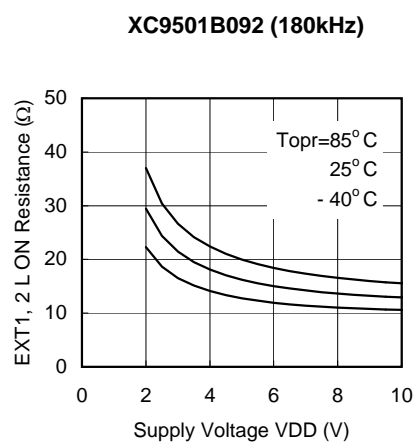

(16) Operation Start-Up Voltage vs. Ambient Temperature

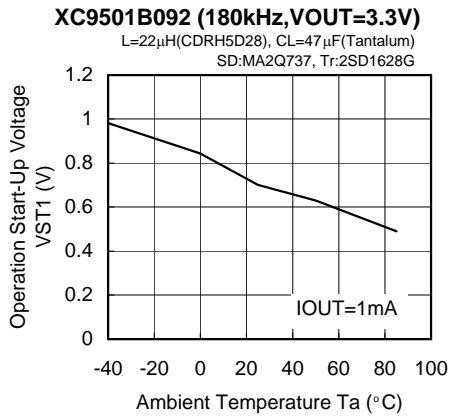

(17) Operation Retention Voltage vs. Ambient Temperature

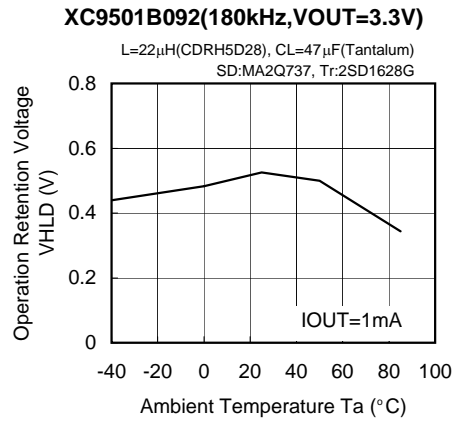

(18) Oscillation Start-Up Voltage vs. Ambient Temperature

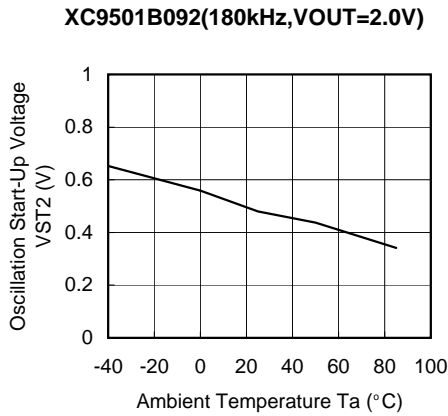

(19) PFM Duty Ratio 1, 2 vs. Supply Voltage

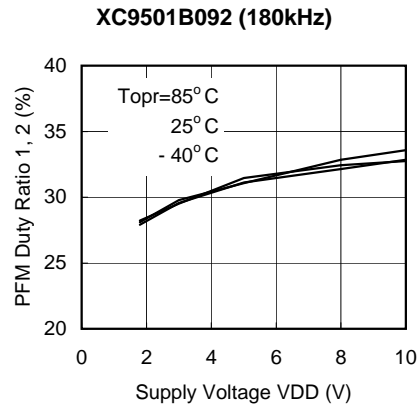

(20) Output Voltage vs. Ambient Temperature

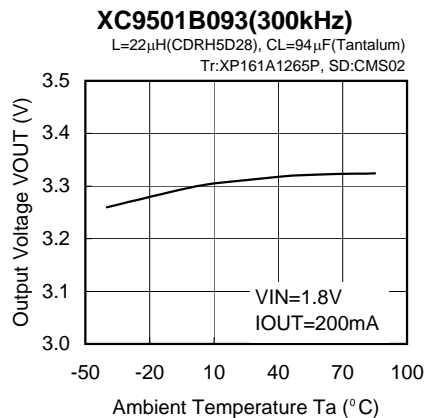

■ Load Transient Response

< VOUT1 = 3.3V, VIN = 2.0V IOUT1, 2 = 100 μ A \leftrightarrow 100mA >

○ PWM Control

FOSC=180kHz, VOUT1, 2=3.3V
VIN=2.0V, IOUT1, 2=100 μ A \rightarrow 100mA

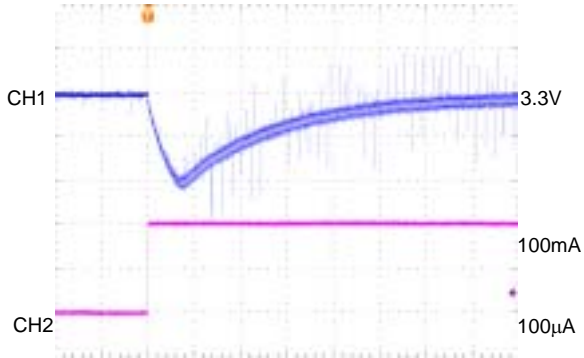

200 μ sec/div
CH1:Vout1, 2, AC-COUPLED, 50mV/div
CH2:Iout1, 2, 50mA/div

FOSC=180kHz, VOUT1, 2=3.3V
VIN=2.0V, IOUT1, 2=100mA \rightarrow 100 μ A

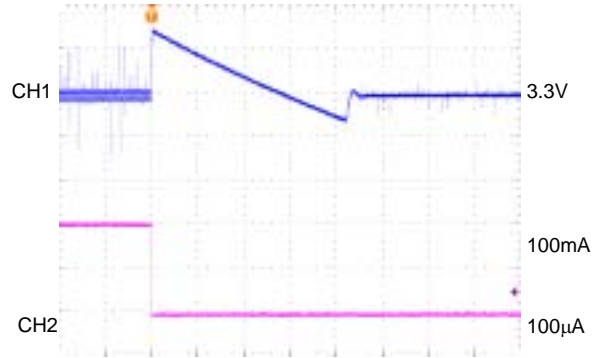

10msec/div
CH1:Vout1, 2, AC-COUPLED, 50mV/div
CH2:Iout1, 2, 50mA/div

○ PWM/PFM Switching Control

FOSC=180kHz, VOUT1, 2=3.3V
VIN=2.0V, IOUT1, 2=100 μ A \rightarrow 100mA

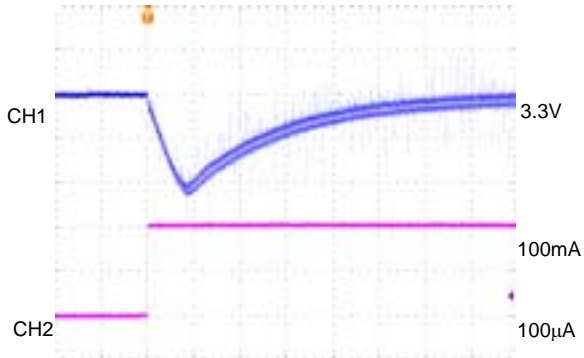

200 μ sec/div
CH1:Vout1, 2, AC-COUPLED, 50mV/div
CH2:Iout1, 2, 50mA/div

FOSC=180kHz, VOUT1, 2=3.3V
VIN=2.0V, IOUT1, 2=100mA \rightarrow 100 μ A

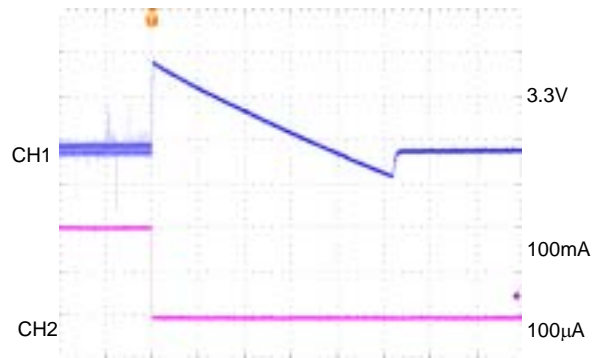

10msec/div
CH1:Vout1, 2, AC-COUPLED, 50mV/div
CH2:Iout1, 2, 50mA/div

< VOUT1 = 3.3V, VIN = 2.0V IOUT1, 2 = 10mA ↔ 100mA >

○ PWM Control

FOSC=180kHz, VOUT1, 2=3.3V
VIN=2.0V, IOUT1, 2=10mA→100mA

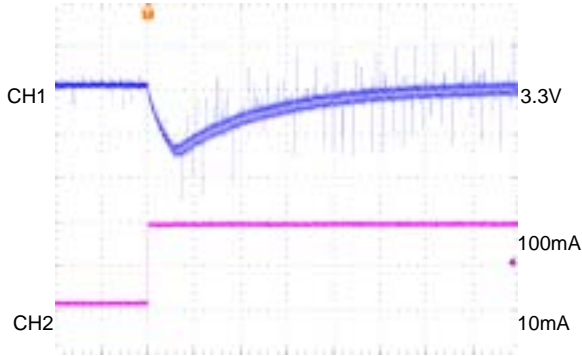

200μsec/div
CH1:Vout1,2, AC-COUPLED, 50mV/div
CH2:Iout1,2, 50mA/div

FOSC=180kHz, VOUT1, 2=3.3V
VIN=2.0V, IOUT1, 2=100mA→10mA

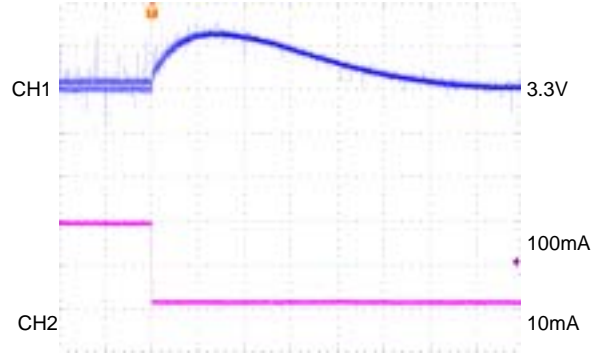

200μsec/div
CH1:Vout1,2, AC-COUPLED, 50mV/div
CH2:Iout1,2, 50mA/div

○ PWM/PFM Switching Control

FOSC=180kHz, VOUT1, 2=3.3V
VIN=2.0V, IOUT1, 2=10mA→100mA

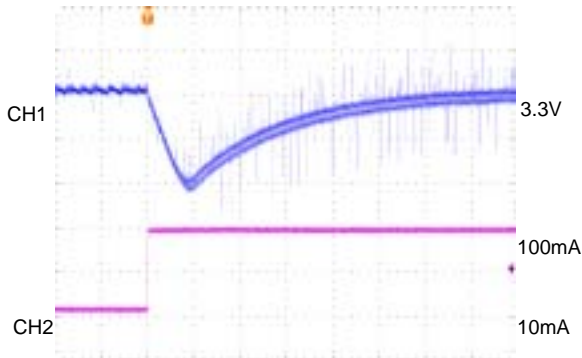

200μsec/div
CH1:Vout1,2, AC-COUPLED, 50mV/div
CH2:Iout1,2, 50mA/div

FOSC=180kHz, VOUT1, 2=3.3V
VIN=2.0V, IOUT1, 2=100mA→10mA



200μsec/div
CH1:Vout1,2, AC-COUPLED, 50mV/div
CH2:Iout1,2, 50mA/div

< PWM Controlled ⇔ PWM / PFM Switching Controlled >

FOSC=180kHz, VOUT1, 2=3.3V
VIN=2.0V, IOUT1, 2=1mA PWM1, 2, 'L'→'H'

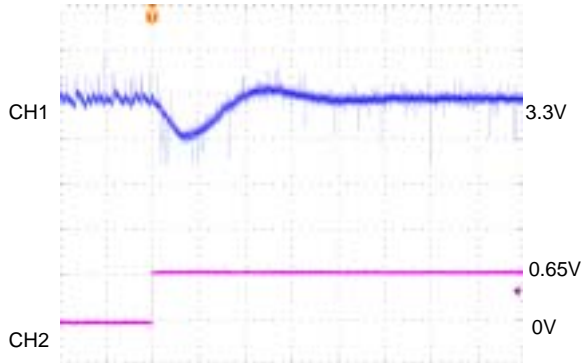

1msec/div
CH1:VOUT1, 2, AC-COUPLED, 10mV/div
CH2:PWM1, 2, 0.5V/div

FOSC=180kHz, VOUT1, 2=3.3V
VIN=2.0V, IOUT1, 2=1mA PWM1, 2, 'H'→'L'

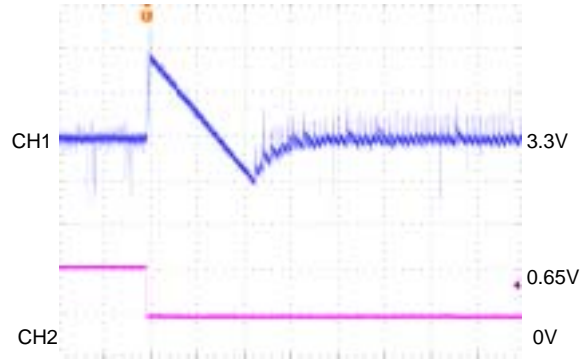

1msec/div
CH1:VOUT1, 2, AC-COUPLED, 10mV/div
CH2:PWM1, 2, 0.5V/div

○ Soft Start Wave Form

FOSC=180kHz, VOUT1, 2=3.3V
VIN=2.0V, IOUT1, 2=100mA
EN1, 2 'L'→'H' CIN=47μF

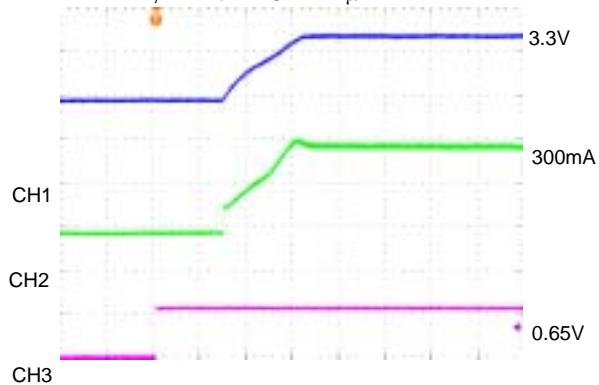

4ms/div
CH1:VOUT1, 2, 1.0V/div
CH2:IIN1, 2, 100mA/div
CH3:EN1, 2, 0.5V/div

* CH1: EN2=GND when measurement
CH2: EN1=GND when measurement