

Low-voltage mixer FM IF system

SA676

DESCRIPTION

The SA676 is a low-voltage monolithic FM IF system incorporating a mixer/oscillator, two limiting intermediate frequency amplifiers, quadrature detector, logarithmic received signal strength indicator (RSSI), voltage regulator and audio and RSSI op amps. The SA676 is available in a 20-pin SSOP (shrink small outline package).

The SA676 was designed for cordless telephone applications in which efficient and economic integrated solutions are required and yet high performance is desirable. Although the product is not targeted to meet the stringent specifications of high performance cellular equipment, it will exceed the needs for analog cordless phones. The minimal amount of external components and absence of any external adjustments makes for a very economical solution.

FEATURES

- Low power consumption: 3.5mA typical at 3V
- Mixer input to >100MHz
- Mixer conversion power gain of 17dB at 45MHz
- XTAL oscillator effective to 100MHz (L.C. oscillator or external oscillator can be used at higher frequencies)
- 102dB of IF Amp/Limiter gain
- 2MHz IF amp/limiter small signal bandwidth
- Temperature compensated logarithmic Received Signal Strength Indicator (RSSI) with a 70dB dynamic range
- Low external component count; suitable for crystal/ceramic/LC filters

PIN CONFIGURATION

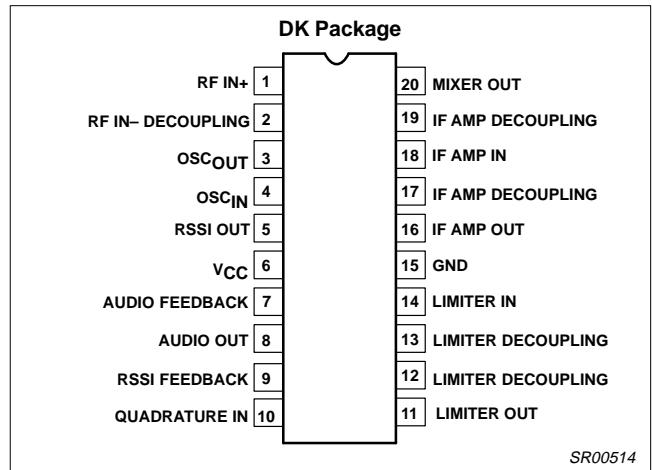

Figure 1. Pin Configuration

- Audio output internal op amp
- RSSI output internal op amp
- Internal op amps with rail-to-rail outputs
- ESD protection: Human Body Model 2kV
Robot Model 200V

APPLICATION

- Cordless phones

ORDERING INFORMATION

DESCRIPTION	TEMPERATURE RANGE	ORDER CODE	DWG #
20-Pin Plastic Shrink Small Outline Package (Surface-mount)	-40 to +85°C	SA676DK	SOT266-1

BLOCK DIAGRAM

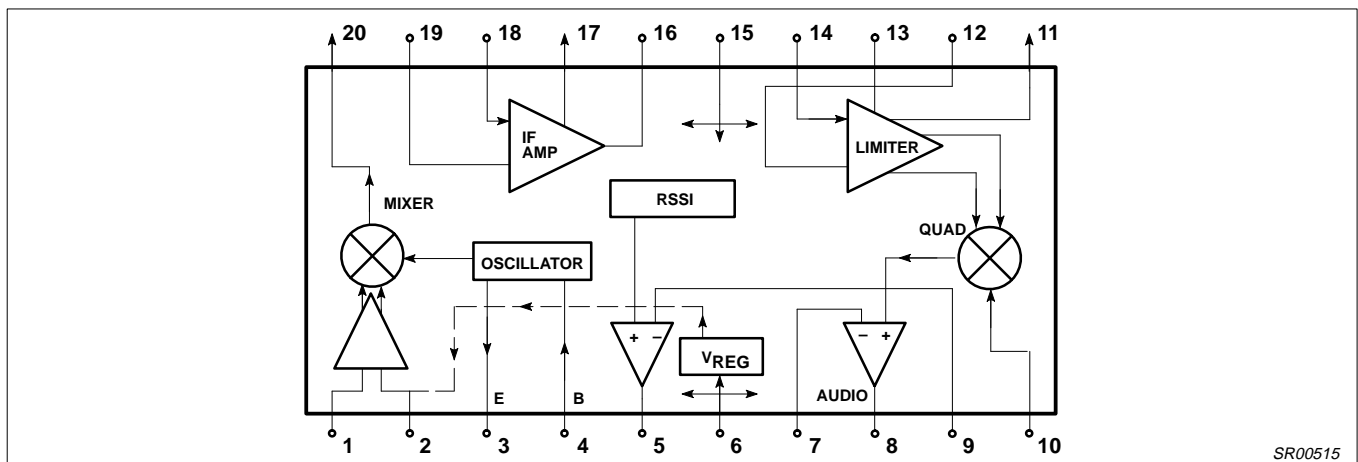

Figure 2. Block Diagram

Low-voltage mixer FM IF system

SA676

ABSOLUTE MAXIMUM RATINGS

SYMBOL	PARAMETER	RATING	UNITS
V_{CC}	Single supply voltage	7	V
T_{STG}	Storage temperature range	-65 to +150	°C
T_A	Operating ambient temperature range	-40 to +85	°C
θ_{JA}	Thermal impedance DK package	117	°C/W

DC ELECTRICAL CHARACTERISTICS

 $V_{CC} = +3V$, $T_A = 25^\circ C$; unless otherwise stated.

SYMBOL	PARAMETER	TEST CONDITIONS	LIMITS			UNITS
			SA676			
			MIN	TYP	MAX	
V_{CC}	Power supply voltage range		2.7		7.0	V
I_{CC}	DC current drain			3.5	5.0	mA

AC ELECTRICAL CHARACTERISTICS

$T_A = 25^\circ C$; $V_{CC} = +3V$, unless otherwise stated. RF frequency = 45MHz; +14.5dBV RF input step-up; IF frequency = 455kHz; $R_{17} = 2.4k\Omega$ and $R_{18} = 3.3k\Omega$; RF level = -45dBm; FM modulation = 1kHz with $\pm 5kHz$ peak deviation. Audio output with de-emphasis filter and C-message weighted filter. Test circuit Figure 3. The parameters listed below are tested using automatic test equipment to assure consistent electrical characteristics. The limits do not represent the ultimate performance limits of the device. Use of an optimized RF layout will improve many of the listed parameters.

SYMBOL	PARAMETER	TEST CONDITIONS	LIMITS			UNITS
			MIN	TYP	MAX	
Mixer/Osc section (ext LO = 220mV_{RMS})						
f_{IN}	Input signal frequency			100		MHz
f_{OSC}	Crystal oscillator frequency			100		MHz
	Noise figure at 45MHz			7.0		dB
	Third-order input intercept point (50 Ω source)	$f_1 = 45.0$; $f_2 = 45.06$ MHz Input RF level = -52dBm		-10		dBm
	Conversion power gain	Matched 14.5dBV step-up	10	17		dB
		50 Ω source		+2.5		dB
	RF input resistance	Single-ended input		8		k Ω
	RF input capacitance			3.0	4.0	pF
	Mixer output resistance	(Pin 20)	1.25	1.5		k Ω
IF section						
	IF amp gain	50 Ω source		44		dB
	Limiter gain	50 Ω source		58		dB
	AM rejection	30% AM 1kHz		50		dB
	Audio level	Gain of two	60	120		mV
	SINAD sensitivity	IF level -110dBm		17		dB
THD	Total harmonic distortion			-55		dB
S/N	Signal-to-noise ratio	No modulation for noise		60		dB
	IF RSSI output, $R_g = 2k\Omega^1$	IF level = -110dBm		0.5	.90	V
		IF level = -50dBm		1.7	2.2	V
	RSSI range			70		dB
	IF input impedance	Pin 18	1.3	1.5		k Ω
	IF output impedance	Pin 16		0.3		k Ω
	Limiter input impedance	Pin 14	1.3	1.5		k Ω
	Limiter output impedance	Pin 11		0.3		k Ω
	Limiter output voltage	Pin 11		130		mV _{RMS}

Low-voltage mixer FM IF system

SA676

AC ELECTRICAL CHARACTERISTICS (Continued)

SYMBOL	PARAMETER	TEST CONDITIONS	LIMITS			UNITS
			MIN	TYP	MAX	
RF/IF section (int LO)						
	System SINAD sensitivity	RF level = -114dBm		12		dB

NOTE:

- The generator source impedance is 50Ω, but the SA676 input impedance at Pin 18 is 1500Ω. As a result, IF level refers to the actual signal that enters the SA676 input (Pin 18) which is about 21dB less than the “available power” at the generator.

CIRCUIT DESCRIPTION

The SA676 is an IF signal processing system suitable for second IF systems with input frequency as high as 100MHz. The bandwidth of the IF amplifier and limiter is at least 2MHz with 90dB of gain. The gain/bandwidth distribution is optimized for 455kHz, 1.5kΩ source applications. The overall system is well-suited to battery operation as well as and high quality products of all types.

The input stage is a Gilbert cell mixer with oscillator. Typical mixer characteristics include a noise figure of 7.0dB, conversion gain of 17dB, and input third-order intercept of -10dBm. The oscillator will operate in excess of 100MHz in L/C tank configurations. Hartley or Colpitts circuits can be used up to 100MHz for xtal configurations.

The output impedance of the mixer is a 1.5kΩ resistor permitting direct connection to a 455kHz ceramic filter. The input resistance of the limiting IF amplifiers is also 1.5kΩ. With most 455kHz ceramic filters and many crystal filters, no impedance matching network is necessary. The IF amplifier has 44dB of gain and 5.5MHz bandwidth. The IF limiter has 58dB of gain and 4.5MHz bandwidth. To achieve optimum linearity of the log signal strength indicator, there must be a 12dB(v) insertion loss between the first and second IF stages. If the IF filter or interstage network does not cause 12dB(v) insertion loss, a fixed or variable resistor or an L pad for

simultaneous loss and impedance matching can be added between the first IF output (Pin 16) and the interstage network. The overall gain will then be 90dB with 2MHz bandwidth.

The signal from the second limiting amplifier goes to a Gilbert cell quadrature detector. One port of the Gilbert cell is internally driven by the IF. The other output of the IF is AC-coupled to a tuned quadrature network. This signal, which now has a 90° phase relationship to the internal signal, drives the other port of the multiplier cell.

The demodulated output of the quadrature drives an internal op amp. This op amp can be configured as a unity gain buffer, or for simultaneous gain, filtering, and 2nd-order temperature compensation if needed. It can drive an AC load as low as 10kΩ with a rail-to-rail output.

A log signal strength indicator completes the circuitry. The output range is greater than 70dB and is temperature compensated. This signal drives an internal op amp. The op amp is capable of rail-to-rail output. It can be used for gain, filtering, or 2nd-order temperature compensation of the RSSI, if needed.

NOTE: $dB(v) = 20\log V_{OUT}/V_{IN}$

Low-voltage mixer FM IF system

SA676

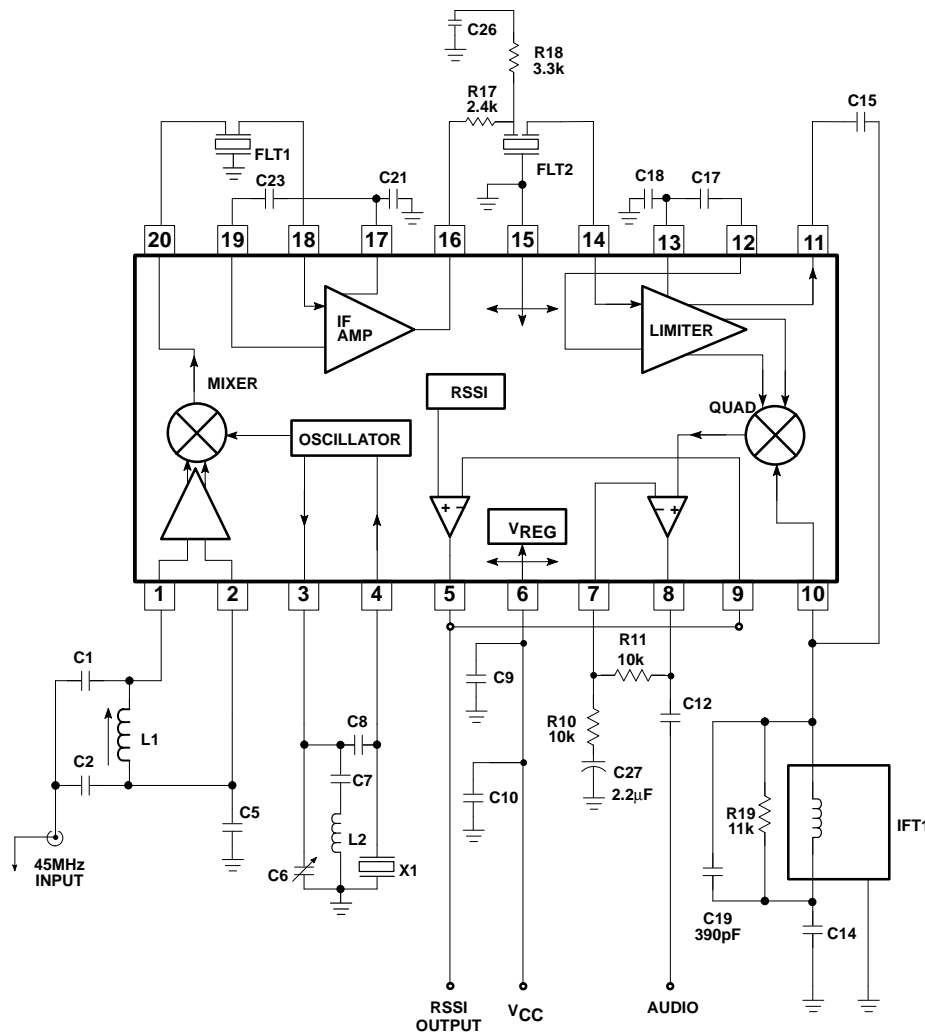

**SA676DK Demoboard
Application Component List**

- | | | | |
|-----|-------------------------------|-------|--|
| C1 | 51pF NPO Ceramic | C23 | 100nF ±10% Monolithic Ceramic |
| C2 | 220pF NPO Ceramic | C26 | 100nF ±10% Monolithic Ceramic |
| C5 | 100nF ±10% Monolithic Ceramic | C27 | 2.2µF Tantalum |
| C6 | 5-30pF trim cap | FLT 1 | Ceramic Filter Murata SFG455A3 or equiv |
| C7 | 1nF Ceramic | FLT 2 | Ceramic Filter Murata SFG455A3 or equiv |
| C8 | 10.0pF NPO Ceramic | IFT 1 | 330µH TOKO 303LN-1130 |
| C9 | 100nF ±10% Monolithic Ceramic | L1 | 330nH Coilcraft UNI-10/142-04J08S |
| C10 | 10µF Tantalum (minimum) * | L2 | 0.8µH nominal TOKO 292CNS-T1038Z |
| C12 | 2.2µF ±10% Tantalum | X1 | 44.545MHz Crystal ICM4712701 |
| C14 | 100nF ±10% Monolithic Ceramic | R5 | Not Used in Application Board (see Note 8, pg 8) |
| C15 | 10pF NPO Ceramic | R10 | 8.2k ±5% 1/4W Carbon Composition |
| C17 | 100nF ±10% Monolithic Ceramic | R11 | 10k ±5% 1/4W Carbon Composition |
| C18 | 100nF ±10% Monolithic Ceramic | R17 | 2.4k ±5% 1/4W Carbon Composition |
| C19 | 390pF ±10% Monolithic Ceramic | R18 | 3.3k ±5% 1/4W Carbon Composition |
| C21 | 100nF ±10% Monolithic Ceramic | R19 | 11k ±5% 1/4W Carbon Composition |

* NOTE: This value can be reduced when a battery is the power source.

Figure 3. SA676 45MHz Application Circuit

Low-voltage mixer FM IF system

SA676

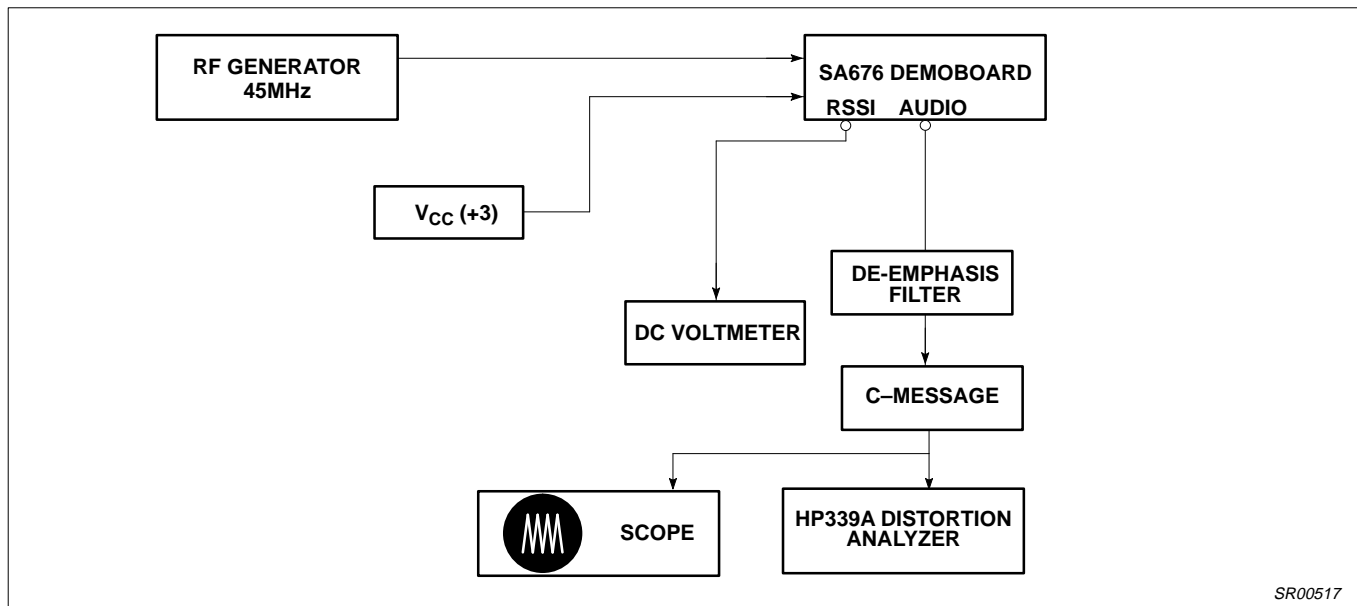

SR00517

Figure 4. SA676 Application Circuit Test Set Up

NOTES:

1. C-message: The C-message and de-emphasis filter combination has a peak gain of 10 for accurate measurements. Without the gain, the measurements may be affected by the noise of the scope and HP339A analyzer. The de-emphasis filter has a fixed -6dB/Octave slope between 300Hz and 3kHz.
2. Ceramic filters: The ceramic filters can be 30kHz SFG455A3s made by Murata which have 30kHz IF bandwidth (they come in blue), or 16kHz CFU455Ds, also made by Murata (they come in black). All specifications and testing are done with the wideband filter.
3. RF generator: Set your RF generator at 45.000MHz, use a 1kHz modulation frequency and a 6kHz deviation if you use 16kHz filters, or 8kHz if you use 30kHz filters.
4. Sensitivity: The measured typical sensitivity for 12dB SINAD should be 0.45 μ V or -114dBm at the RF input.
5. Layout: The layout is very critical in the performance of the receiver. We highly recommend our demo board layout.
6. RSSI: The smallest RSSI voltage (i.e., when no RF input is present and the input is terminated) is a measure of the quality of the layout and design. If the lowest RSSI voltage is 500mV or higher, it means the receiver is in regenerative mode. In that case, the receiver sensitivity will be worse than expected.
7. Supply bypass and shielding: All of the inductors, the quad tank, and their shield must be grounded. A 10-15 μ F or higher value tantalum capacitor on the supply line is essential. A low frequency ESR screening test on this capacitor will ensure consistent good sensitivity in production. A 0.1 μ F bypass capacitor on the supply pin, and grounded near the 44.545MHz oscillator improves sensitivity by 2-3dB.
8. R5 can be used to bias the oscillator transistor at a higher current for operation above 45MHz. Recommended value is 22k Ω , but should not be below 10k Ω .

Low-voltage mixer FM IF system

SA676

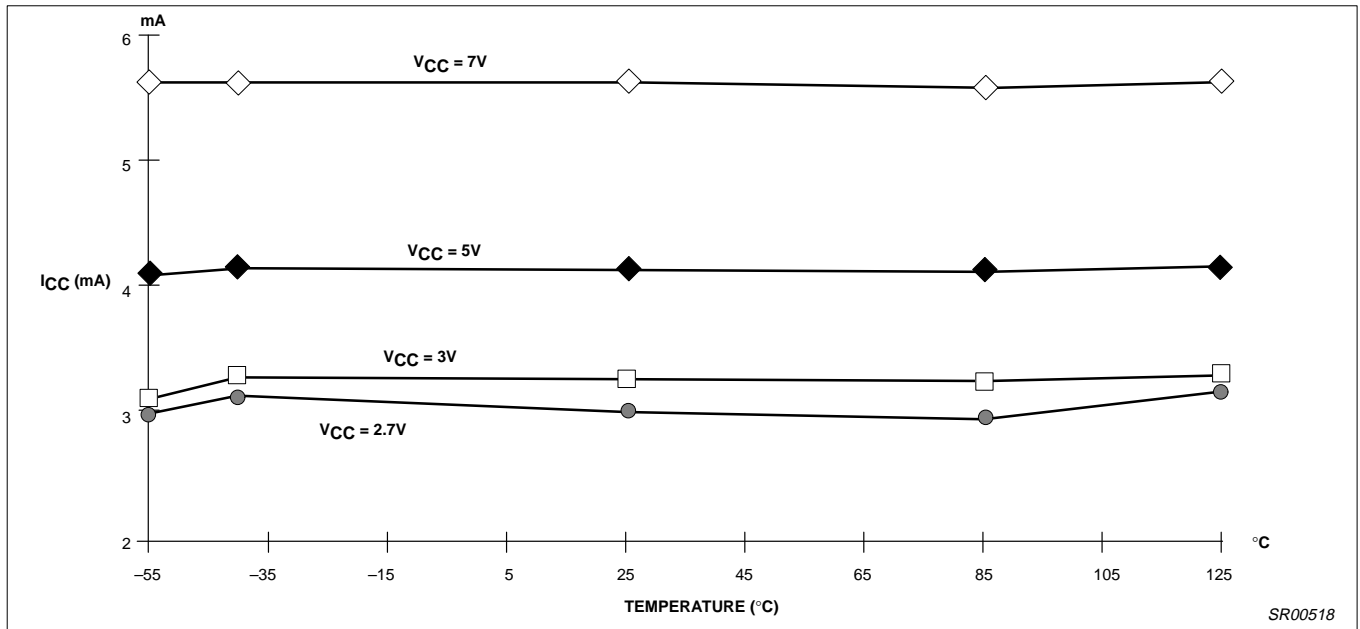

Figure 5. I_{CC} vs Temperature and Supply Voltage

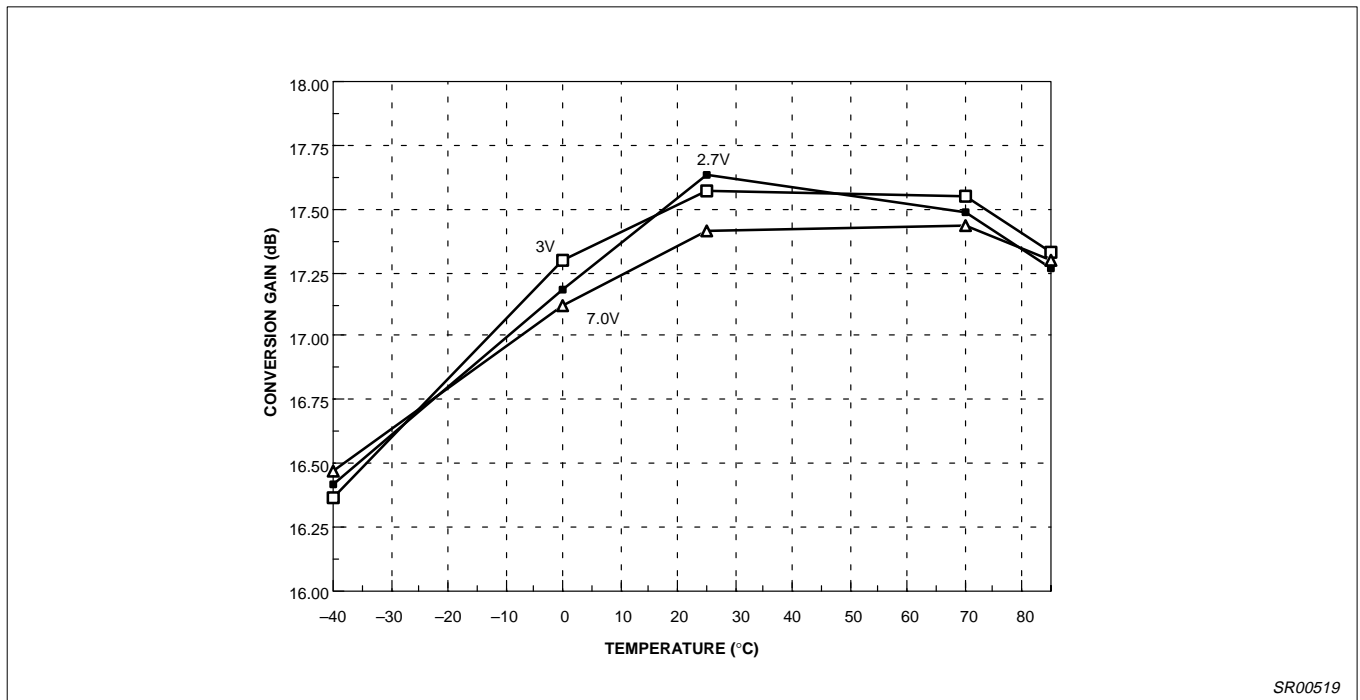

Figure 6. Conversion Gain vs Temperature and Supply Voltage

Low-voltage mixer FM IF system

SA676

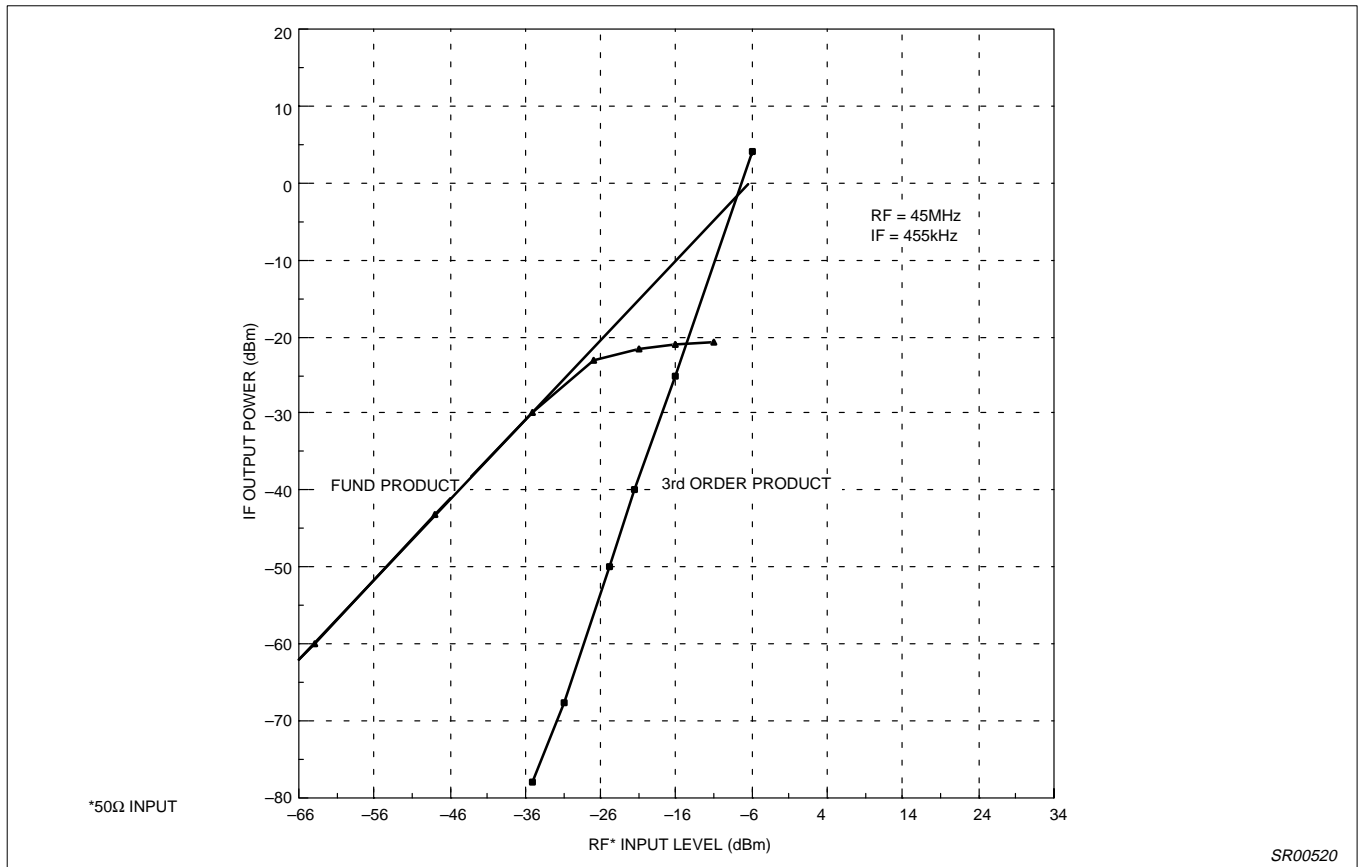

Figure 7. Mixer Third Order Intercept and Compression

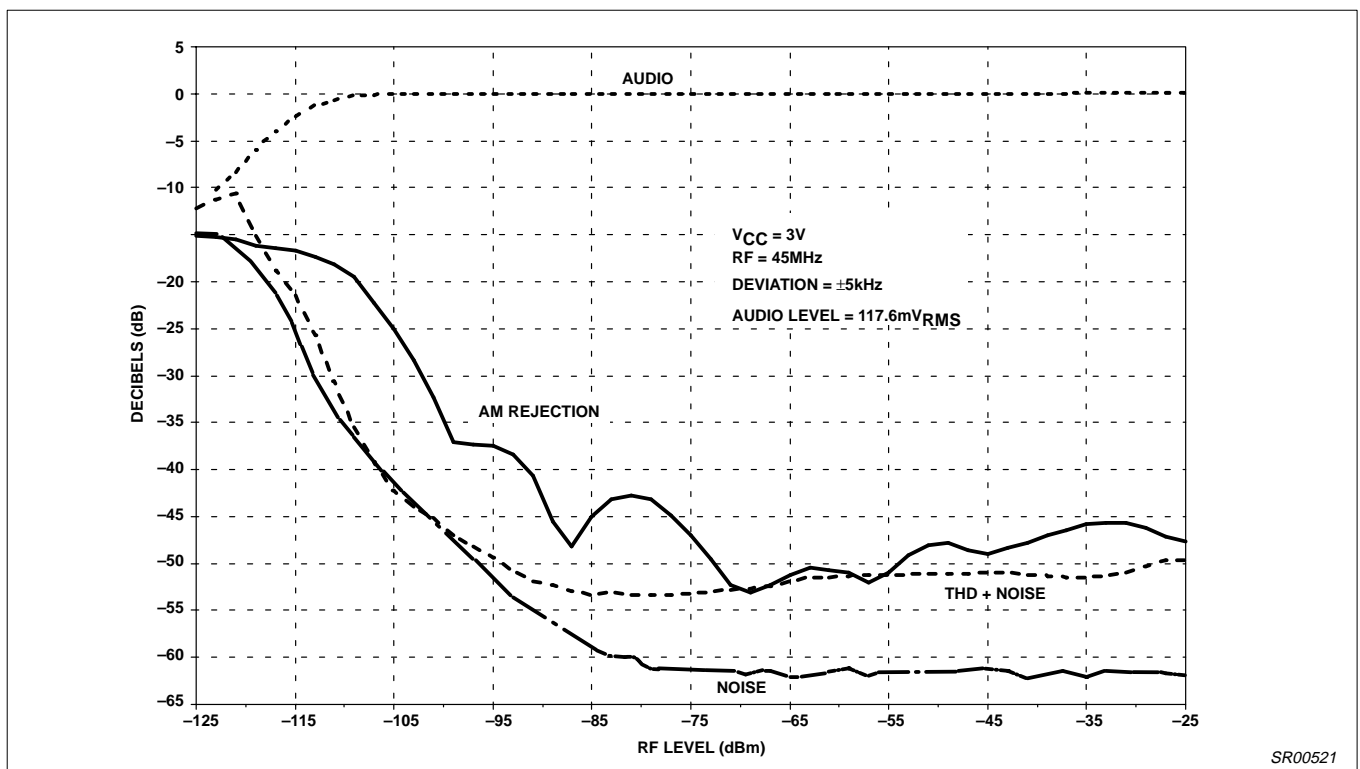

Figure 8. Sensitivity vs RF Level (+25°C)

Low-voltage mixer FM IF system

SA676

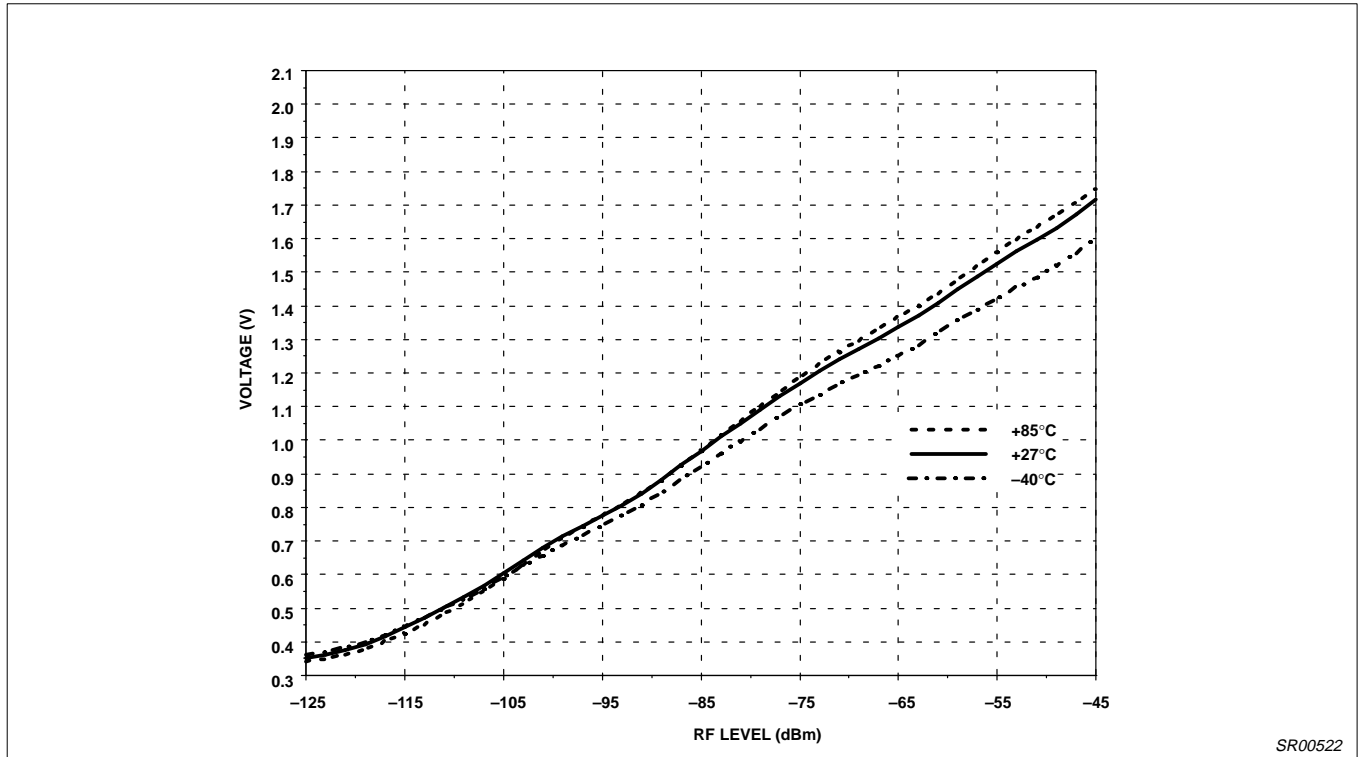

Figure 9. RSSI vs RF Level and Temperature - $V_{CC} = 3V$

SR00522

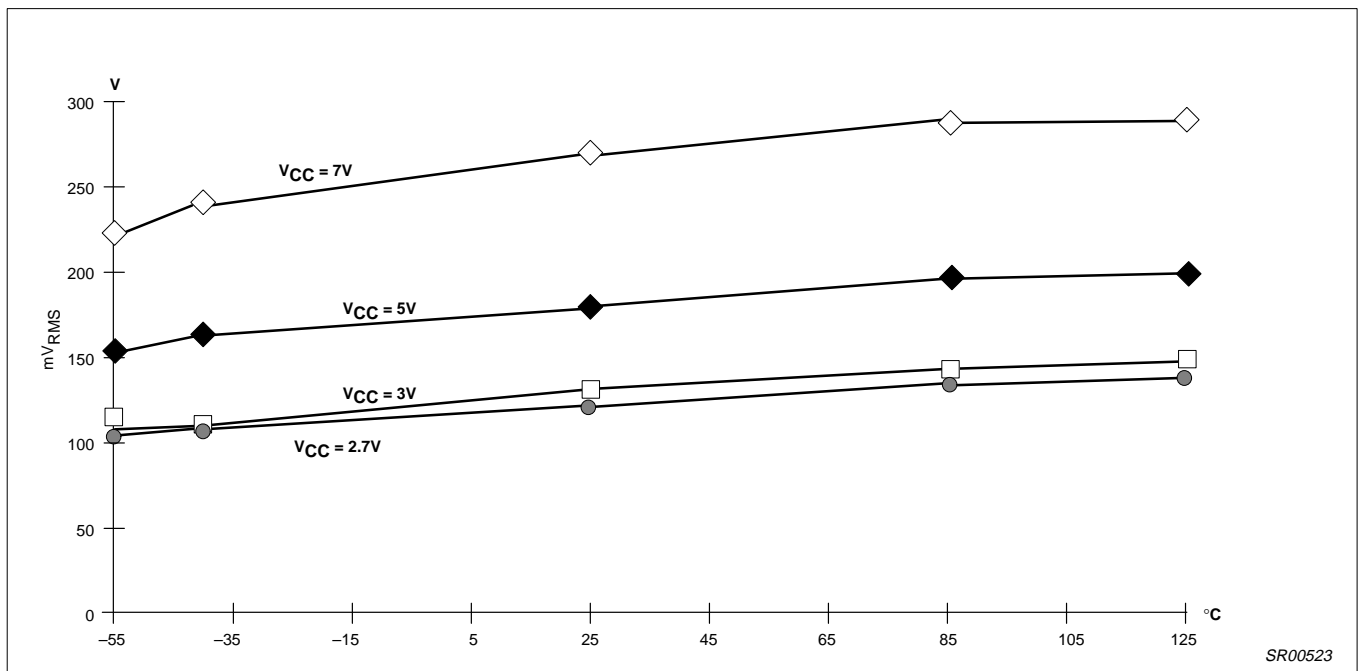

Figure 10. Audio Output vs Temperature and Supply Voltage

SR00523