

MC73110

Advanced 3-Phase Motor Control IC Developer's Kit Manual



Performance Motion Devices, Inc.
55 Old Bedford Road
Lincoln, MA 01773



NOTICE

This document contains proprietary and confidential information of Performance Motion Devices, Inc., and is protected by federal copyright law. The contents of this document may not be disclosed to third parties, translated, copied, or duplicated in any form, in whole or in part, without the express written permission of Performance Motion Devices, Inc.

The information contained in this document is subject to change without notice. No part of this document may be reproduced or transmitted in any form, by any means, electronic or mechanical, for any purpose, without the express written permission of Performance Motion Devices, Inc.

Copyright 1998, 1999, 2000, 2001, 2002, 2003 by Performance Motion Devices, Inc.
Navigator[®], Pro-Motion[®] and C-Motion[®] are registered trademarks of Performance Motion Devices, Inc.

Warranty

Performance Motion Devices, Inc. (PMD) warrants performance of its products to the specifications applicable at the time of sale in accordance with Performance Motion Devices, Inc.'s standard warranty. Testing and other quality control techniques are utilized to the extent Performance Motion Devices, Inc. deems necessary to support this warranty. Specific testing of all parameters of each device is not necessarily performed, except those mandated by government requirements. Performance Motion Devices, Inc. reserves the right to make changes to its products or to discontinue any product or service without notice, and advises customers to obtain the latest version of relevant information to verify, before placing orders, that information being relied on is current and complete. All products are sold subject to the terms and conditions of sale supplied at the time of order acknowledgement, including those pertaining to warranty, patent infringement, and limitation of liability.

Safety Notice

Certain applications using semiconductor products may involve potential risks of death, personal injury, or severe property or environmental damage. Products are not designed, authorized, or warranted to be suitable for use in life support devices or systems or other critical applications. Inclusion of Performance Motion Devices, Inc. products in such applications is understood to be fully at the customer's risk. In order to minimize risks associated with the customer's applications, adequate design and operating safeguards must be provided by the customer to minimize inherent procedural hazards.

Disclaimer

Performance Motion Devices, Inc. assumes no liability for applications assistance or customer product design. Performance Motion Devices, Inc. does not warrant or represent that any license, either express or implied, is granted under any patent right, copyright, mask work right, or other intellectual property right of Performance Motion Devices, Inc. covering or relating to any combination, machine, or process in which such products or services might be or are used. Performance Motion Devices, Inc.'s publication of information regarding any third party's products or services does not constitute Performance Motion Devices, Inc.'s approval, warranty or endorsement thereof.



Related Documents

MC73110 Advanced 3-Phase Motor Control IC Product Manual (MC73110PM)

Electrical Specifications, Theory of Operations, and Command Reference for MC73110 IC.

1.0 Product Overview	7
2.0 Installation	9
2.1 Software	11
2.2 Documentation	11
2.3 Connection Configurations	12
2.4 Installation Sequence	13
2.5 Required Hardware	13
2.6 Preparing the Card for Installation	14
2.7 Connecting to the Card	15
2.7.1 Initial Setup	15
2.7.2 Power Connector (J1)	16
2.7.3 Motor Feedback Connector (J2)	16
2.7.4 Motor Connector (J4)	17
2.7.5 Host Connector (J6)	17
2.7.6 Serial Port Connector (J7)	18
2.8 Applying Power	18
2.8.1 Card Reset	18
2.8.2 LED Status Indicators	18
2.9 Software Installation	19
2.10 First Time System Verification	19
3.0 Using Pro-Motion	21
3.1 Communication	22
3.1.1 Axis Setup Wizard	23
3.1.1 Step #1: Signal Output Settings	24
3.1.2 Step #2: Initialize Signal Sensing	24
3.1.3 Step #3: Safety Settings	25
3.1.4 Step #4: Commutation	25
3.1.4.1 Step #4a: Check Commutation	26
3.1.5 Step #5: Velocity Integrator Loop Parameters	26
3.1.6 Step #6: Velocity Loop Parameters	26
3.2.6 Step #7: Current Loop Parameters	27
3.2.7 Step #8: Miscellaneous Settings	27
3.2 Main Window	28
3.2.1 Project Window	28
3.2.2 Command Window	29
4.0 Developing Your Own Applications with C-Motion	31
4.1 Theory of Use	32
5.0 MC73110 Electrical Reference	33
5.1 User-Settable Jumper Options	33
5.2 Connecting to the Card	34
5.2.1 Power Connector (J1)	35
5.2.2 Motor Feedback Connector (J2)	36
5.2.3 RS485 Connector (J3)	37
5.2.4 Motor Connector (J4)	37
5.2.5 Remote Switcher Connector (J5)	38
5.2.6 Host Connector (J6)	39
5.2.7 Serial Port Connector (J7)	39



1.0 Product Overview

	MC73110 Motor Control IC	Navigator/Pilot	Magellan	Motion Cards
Number of axes	1	1, 2, 4	1, 2, 3, 4	1, 2, 3, 4
Package	64-pin TQFP	132-pin PQFP 100-pin PQFP	144-pin TQFP 100-pin TQFP	PCI PC/104
Voltage	3.3V	5V	3.3V	3V
Function	Velocity control Torque control Commutation Encoder input	Position control Encoder input Profile generation Commutation	Position control Encoder input Profile generation Commutation Network communications Multi-motor	Position control Encoder input Profile generation Commutation Signal conditioning Analog output Trace buffer
Motor types	Brushless DC	DC servo Brushless DC Microstepping Pulse & direction	DC servo Brushless DC Microstepping Pulse & direction	DC servo Brushless DC Microstepping Pulse & direction
Communication	Standalone Serial	Parallel Serial point-to-point Serial multi-drop	Parallel Serial point-to-point Serial multi-drop CANbus	PCI, PC104
Loop rate	20 kHz	100 -150 □Sec/axis	50 -75 □Sec/axis	50 -75 □Sec/axis

The **MC73110 Motor Control IC** is a single-chip, single-axis device ideal for use in intelligent 3-phase brushless motor amplifiers. It provides sophisticated programmable digital current control with direct analog input of feedback signals. It can be operated in voltage, torque, or velocity modes and supports standalone operation for use with PMD's motion processors, other off-the-shelf servo controllers, or via a serial port.

Navigator/Pilot-family Motion Processors provide programmable chip-based positioning control for brushed servo, brushless servo, microstepping, and pulse and direction step motors. They are available in 1, 2 and 4-axis, and in both single-chip and two-IC chipset configurations. These parts operate at 5V.

Magellan-family Motion Processors are state-of-the-art programmable chip-based positioning controllers for brushed servo, brushless servo, microstepping, and pulse and direction step motors. They are similar to the Navigator Motion Processors but provide increased capabilities including faster loop rate, CANBus communications, software-selectable motor type, and direct SPI bus output for serial DACs. They are available in 1, 2, 3, and 4-axis, and in both single-chip and two-IC chipset configurations. These parts operate at 3.3V.

PMD's PCI and PC/104-bus motion cards are high performance general purpose motion cards for controlling DC-brush, brushless DC, microstepping, and pulse & direction motors. Utilizing PMD's Magellan Motion Processors, these products are available in 1, 2, 3, and 4 axis configurations and have advanced features such as 16-bit D/A analog output, and on-board high speed performance tracing.



2.0 Installation

In This Section

- ▶ Software
- ▶ Documentation
- ▶ Connection Configurations
- ▶ Installation Sequence
- ▶ Required Hardware
- ▶ Preparing the Card for Installation
- ▶ Connecting to the Card
- ▶ Applying Power
- ▶ Software Installation
- ▶ First Time System Verification

The PMD MC73110 Developer's Kit is an integrated board/software package that serves as an electrical and software design tool for MC73110-based systems. The major components of the kit are:

- Standalone MC73110-based card with 10 amp 3-phase brushless motor amplifier
- Serial cable to communicate with PC
- CD-ROM containing C-Motion and Pro-Motion software programs
- MC73110 Product Manual
- MC73110 Developer's Kit Manual

The Developer's Kit is a self-standing card supported by aluminum standoff 4.093" x 6.800" in size. The PCB board is FR-4 four-layer with 2 oz. copper. The thickness is 62 mil. It accepts a single power connection of 18V to 48V, from which the card itself derives all other needed voltages using an on-board DC to DC converter device.

During initial setup and operation, a serial cable connects the card to a PC, which runs PMD's Pro-Motion exerciser program. The serial port can be operated in point-to-point mode, or multi-drop mode. The card can also be operated standalone, without serial port connection. In this mode the card receives a command from an external motion controller via analog or digital hardware signals. When operated in standalone mode, MC73110 parameters are loaded into the MC73110 at power up via an on-board serial EEPROM which is installed in an 8-pin DIP socket located on the Developer's Kit card.

The card drives a 3-phase brushless DC motor at up to 10 amps continuous current, 15 amps peak. A wide range of motor inductances are supported. An on-card temperature sensor can be used to alert the user of an over-temperature condition on the amplifier.

The following diagram provides a summary of the functions of the MC73110 Developer Kit card.

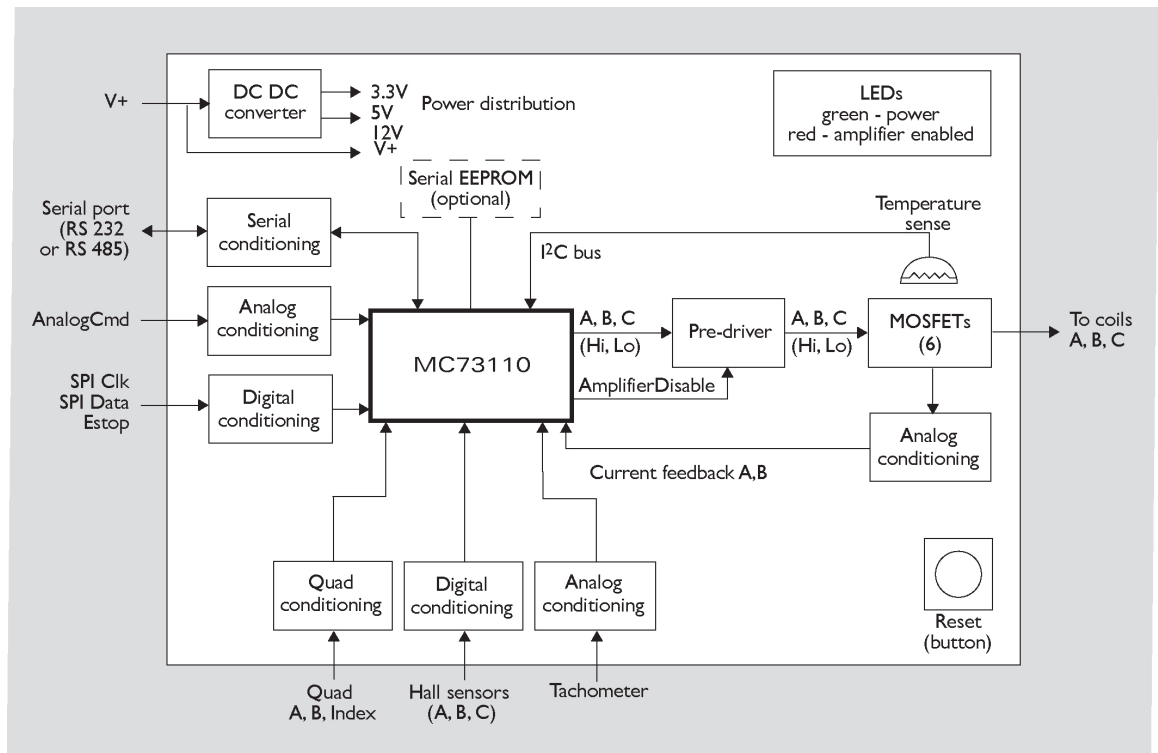

The Developer's Kit can be used for a number of purposes. It is useful as a:

- 'Ready to go' system that exercises the MC73110
- Reference design for an MC73110-based amplifier/drive
- Pre-production system with which the user's application can be developed, and motors can be tested
- Test system from which various switching power block sections can be tested

2.1 Software

Two major software packages are provided with the MC73110 Developer's Kit cards: Pro-Motion, an interactive Windows-based exerciser program and C-Motion, a C-language library which simplifies the development of motion applications for MC73110 Developer's Kit cards.

Pro-Motion is a sophisticated, easy to use exerciser program that allows you to set and view all card parameters, and exercise all card features. Pro-Motion features include:

- Project window for accessing card parameters
- Ability to save and load current settings
- Motor-specific parameter setup
- Command window for direct text command entry.
- Communications monitor that echoes all commands sent by Pro-Motion to the card.

C-Motion provides a convenient set of callable routines that comprise all of the code required for controlling your MC73110 Developer's Kit card. C-Motion includes the following features:

- Axis virtualization
- The ability to communicate to multiple MC73110 Developer's Kit cards
- Can be easily linked to any "C/C++" application

Pro-Motion is described in *section 3, Using Pro-Motion, page 21*, C-Motion is described in detail in *section 4, Developing Your Own Applications with C-Motion, page 31*.

2.2 Documentation

There are two manuals specifically associated with the MC73110 card. A brief description of each is listed below.

Component part number	Name	Description
MC73110PM	MC73110 Product Manual	This is the complete description of the MC73110 IC. It includes electrical specifications, theory of operations, and a programmer's command reference.
DK73110M	MC73110 Developer's Kit Manual	This document guides you through installation and operation of the MC73110 Developer's Kit. It describes the Developer's Kit card and software, and provides complete schematics for the card.

To download these documents, or request that they be sent to you, visit the PMD website at www.pmdcorp.com or contact your PMD representative.

2.3 Connection Configurations

There are two major connection configurations of the MC73110 Developer's Kit. The first is 'internal switcher', and the second is 'remote switcher'.

Internal switcher means that the Developer's Kit uses its internal 10 Amp continuous (15 amp peak) on-board MOSFET switchers and current sense circuitry to form a complete standalone intelligent amplifier card. This is the normal operating state of the system, and the most convenient to use when initially working with the MC73110 Developer's Kit.

Remote switcher means that an external switching triple half-bridge and associated current sense and conditioning circuitry is installed. *Section 5, Electrical Reference, page 33*, provides complete details on the signals that are required to connect to an external amplifier. This configuration is useful for prototyping with a custom-designed amplifier for the purpose of verifying your own amplifier design, or driving motors with a larger current capacity than 10 Amps continuous.

The diagrams below illustrate these two configurations.

Internal switcher configuration

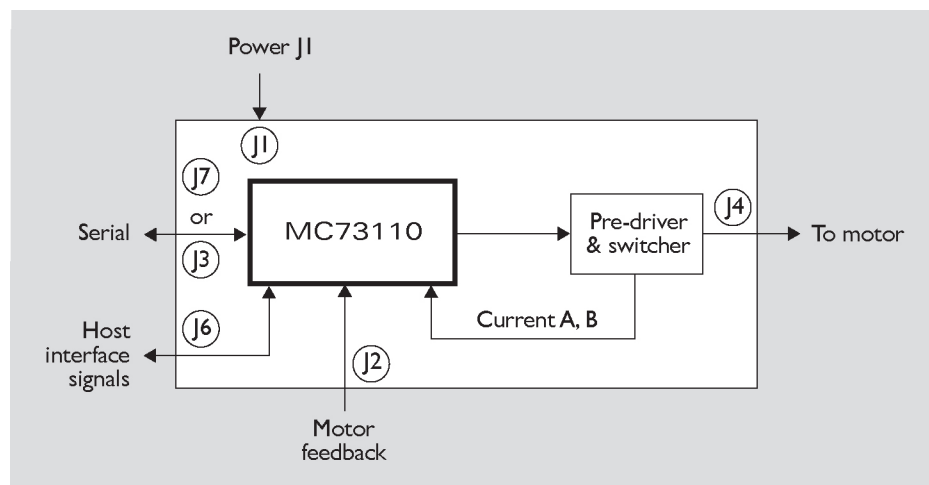

Remote switcher configuration

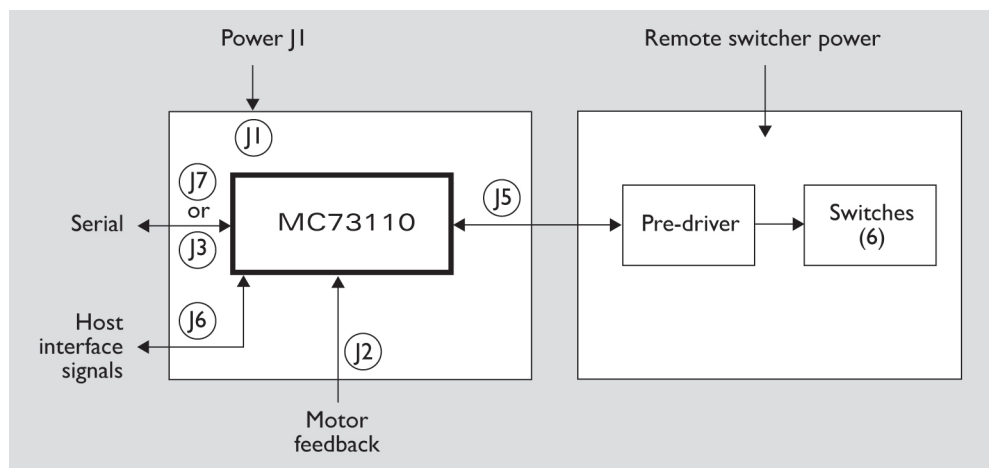

2.4 Installation Sequence

For a normal installation of a MC73110 Developer's Kit card, you will need to configure your card for the connection configuration you will be using (internal or remote). Configuration of the MC73110 Developer's Kit card is described in detail in *section 2.6, Preparing the Card for Installation, see page 14*.

Next you will need to connect your system's motors, encoders, amplifiers, and sensors as desired to operate your motion hardware. A description of the connections that are made for the MC73110 Developer's Kit card is found in *section 2.7, Connecting to the Card, see page 15*.

Once this hardware configuration is complete, you should then install the software. Installation of the software is described in *section 2.9, Software Installation, see page 19*.

The final step to finish the installation is to perform a functional test of the finished system. This is described in *section 2.10, First Time System Verification, see page 19*.

Once all of the above has been accomplished installation is complete, and you are ready to operate the card.

2.5 Required Hardware

To operate the MC73110 Developer's Kit card with Pro-Motion, the Windows-based exerciser program, you will need the following hardware:

- 1 The recommended platform is an Intel (or compatible) processor, Pentium or better, 5 MB of available disk space, 32MB of available RAM, and a CDROM drive. The PC operating system required is Windows 9X/ME/NT/2000/XP.
- 2 A 3-phase Brushless DC Motor with Hall sensors and optional quadrature encoder feedback with index.
- 3 Cables as required to connect to the MC73110 Developer's Kit card to your motor, to your encoder, to the card power input, to the analog or digital command signals. In addition you will connect the PC to the card via an included DB-9 cable. For complete descriptions of these connections see *section 2.7, Connecting to the Card, page 15*.

2.6 Preparing the Card for Installation

The following table shows the user-settable jumper options for the MC73110 Developer's Kit card. For jumper locations see the diagram on the bottom of the page.

Jumper	Jumper setting	Description
JP1, JP2	1-2	Selects RS-232 communication using on-board transceiver. This is the default position of this jumper.
	2-3	Selects RS-485 communication using user-provided daughtercard. For a complete description of the electrical requirements of this daughtercard, see section 5.2.3, <i>RS-485 Connector</i> , page 39.
	3-4	Reserved
JP3-JP5	1-2	Reserved, must be set to 1-2
JP6, JP7	1-2	Selects use of on board amplifier/switcher. This is the default setting.
	2-3	Selects use of remote amplifier/switcher. This setting is useful to verify custom amplifier design or to connect to more powerful switching blocks.
JP9, JP10	1-2	Reserved, must be set to 1-2.

In addition, the following resistor packs should be installed depending on whether single or differential quadrature encoders are used.

Resistor pack	How to set	Description
J8	Installed <i>this is the default setting</i>	If you are using differential connections leave the resistor pack installed.
	Removed	If you are using single-ended encoder connections, remove the resistor pack.

Figure 1-1.
Location of
various board
elements

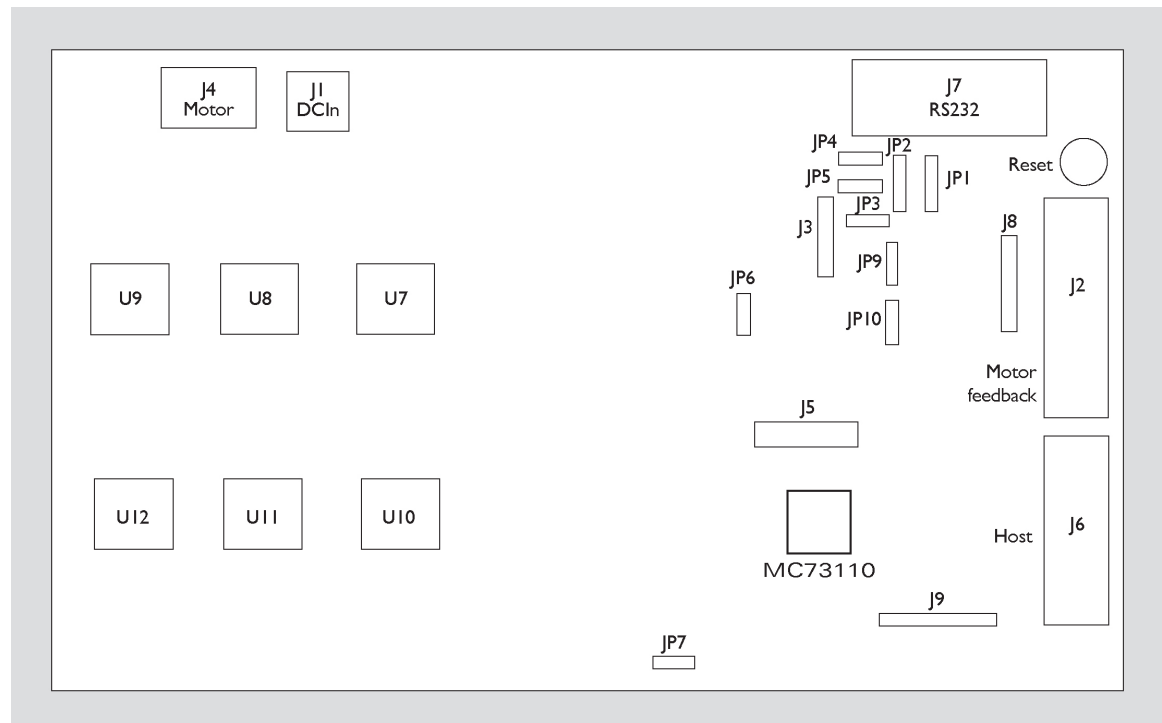

2.7 Connecting to the Card

There are a total of seven connectors that can be used with the MC73110 Developer's Kit card as follows:

Connector	Name	Function
J1	Power	Provides operating power to the Developer's Kit card.
J2	Motor feedback	Inputs various motor-related signals.
J3	RS-485	Provides communication to/from the card when a multi-drop RS485 is used.
J4	Motor	Provides high voltage, high current connections to the motor from the amplifier output.
J5	Remote switcher	Inputs and outputs various signals for use with a remote switching block.
J6	Host	Inputs and outputs various non-motor command and feedback signals to/from the Developer's Kit card.
J7	Serial port	Provides RS-232 communication to/from the card using an on-card transceiver driver chip. This connector is designed to interface without null-modem or other changes to a DB-9 PC serial port.

Here is a summary of the connector types expected for these 7 connectors:

Connector	Signal type	# pins	Type
J1	High power	2	Through-hole terminal block (screw connection)
J2	Low power digital & analog	14	Side-facing single row shrouded header (1-in-line 0.100" pitch friction lock header)
J3	Low power digital	5	1-in-line 0.100" pitch header
J4	High power	3	Through-hole terminal block (screw connection)
J5	Low power digital & analog	16	8 x 2 vertical header (2mm pitch)
J6	Low power digital & analog	12	Side-facing single row shrouded header (1-in-line 0.100" pitch friction lock header)
J7	Low power digital	9	Side-facing D-sub 9 (Female)

2.7.1 Initial Setup

To initially set up the Developer's Kit card for checkout and verification, four connectors must be used - J1 (Power), J2 (motor feedback), J4 (motor), and J7 (serial port). In addition, the host connector (J6) is frequently used during testing after initial setup, in which case the serial port becomes optional. The signal connections for these connectors are indicated in the following sections. For a complete description of all connectors see *section 5, Electrical Reference, page 33*.

2.7.2 Power Connector (J1)

The power connector provides power to the card. All other voltages used by the card are derived from this central supply using an on-card DC-DC converter. The voltage provided at these connections matches the voltage at which the motor will be driven.

Pin #	Signal name	Description
1	V+	18 - 48V. Current capacity specification should be maximum motor drive + lamp (to power the card)
2	PowerGnd	Ground return for V+

2.7.3 Motor Feedback Connector (J2)

The motor feedback connector inputs various motor-related signals to the Developer's Kit card. All these signals are low power, low voltage digital or analog signals.

Pin #	Signal	Description
1	+5V	This signal provides 5V. This is often useful to power the encoder circuitry.
2	GND	This signal provides the digital return.
3	QuadA+	This input signal provides the high side of the differential quadrature input for encoder phase A. For more information on connecting encoders see <i>section 2.6, Preparing the Card for Installation, page 14</i> . If unused this signal may be left unconnected.
4	QuadA-	This input signal provides the low side of the differential quadrature input for encoder phase A. When using a single-ended encoder, this pin should be left unconnected. For more information on connecting encoders see <i>section 2.6, Preparing the Card for Installation, page 14</i> . If unused this signal may be left unconnected.
5	QuadB+	This input signal provides the high side of the differential quadrature input for encoder phase B. For more information on connecting encoders see <i>section 2.6, Preparing the Card for Installation, page 14</i> . If unused this signal may be left unconnected.
6	QuadB-	This input signal provides the low side of the differential quadrature input for encoder phase B. When using a single-ended encoder, this pin should be left unconnected. For more information on connecting encoders see <i>section 2.6, Preparing the Card for Installation, page 14</i> . If unused this signal may be left unconnected.
7	Index+	This input signal provides the high side of the differential quadrature input for the Index signal. For more information on connecting encoders see <i>section 2.6, Preparing the Card for Installation, page 14</i> . If unused this signal may be left unconnected.
8	Index-	This input signal provides the low side of the differential quadrature input for the Index signal. When using a single-ended encoder, this pin should be left unconnected. For more information on connecting encoders see <i>section 2.6, Preparing the Card for Installation, page 14</i> . If unused this signal may be left unconnected.
9	GND	This signal provides the digital return.
10	HallA	These signals are the Hall sensor inputs. For logic "0", the signal should be lower than 0.5V; for logic "1", the signal should be greater than 1.5V.
11	HallB	
12	HallC	
13	TachIn+	This is the positive input signal for the analog tachometer signal. This signal represents the instantaneous speed of the motor. The input range is +/- 60V. If unused this signal may be left unconnected.
14	TachIn- (GND)	This is the negative input for the analog tachometer signal. The input range is +/- 60V. If unused this signal may be left unconnected.

2.7.4 Motor Connector (J4)

The motor connector provides the high voltage 3-phase outputs from the amplifier/switcher to the motor.

Pin #	Signal	Description
1	MotorC	Leg 3 of 3 motor coil connections
2	MotorB	Leg 2 of 3 motor coil connections
3	MotorA	Leg 1 of 3 motor coil connections

2.7.5 Host Connector (J6)

The Host connector inputs and outputs various non-motor related signals to/from the Developer's Kit card

Pin #	Signal	Description
1	Estop	This digital input provides an emergency stop signal to the Developer's Kit card. Although its function and interpretation are programmable, normally a high signal (greater than 1.5V) indicates an emergency stop is not active; and a low signal (less than .5V) indicates that it is active. If unused this signal may be left unconnected.
2	AmplifierDisable	This digital output signal provides a programmable output signal indicating the internal state of the MC73110. Normally, a low output indicates an error; while a high signal indicates no error. In addition to being an output at this connector, this signal is also used internally by the MC73110 Developer's Kit card to shut down the amplifier's switchers when the amplifier operates in 'internal switcher' mode.
3	GND	This signal provides a digital ground return.
4	DigitalCmdClk	This digital input signal provides the SPI datastream 'clock' signal.
5	DigitalCmdData	This digital input signal provides the SPI datastream 'data' signal
6	GND	This signal provides a digital ground return.
7	+5V	This signal outputs provides 5V to external circuitry.
8	n.c.	—
9		
10	AnalogCmd+	This analog input signal provides the positive input of the analog command. Depending on how the MC73110's control loop has been programmed, this signal represents the desired voltage, torque or velocity. The input range is +/-10V. The reference input can be differential or single-ended.
11	AnalogCmd-	This analog input signal provides the negative input of the analog command. Depending on how the MC73110's control loop has been programmed, this signal represents the desired voltage, torque or velocity. The input range is +/-10V. The reference input can be differential or single-ended. When it is single-ended, AnalogCmd- must be connected to AGND, pin 12.
12	AGND	This signal provides an analog ground return

2.7.6 Serial Port Connector (J7)

The RS-232 serial connector provides communication to/from the card using an on-card transceiver driver chip. This connector is designed to interface without null-modem or other changes to the DB-9 PC serial port. These signals are low power, low voltage digital or analog signals.

Pin #	Signal	Description
2	SrIXmt	Serial transmit signal from the MC73110 Developer's Kit transceiver chip.
3	SrIRcv	Serial receive signal to the MC73110 Developer's Kit card.
5	GND	Ground

2.8 Applying Power

Once you have installed or removed the correct jumpers and resistor packs, and once you have made the correct connections to your hardware, installation is complete and the Developer's Kit is ready for operation.

Upon application of power through connector J1, the card will be in a reset condition. Assuming that the flash hasn't been programmed or that a serial EEPROM hasn't been installed, the MC73110 will utilize its default values, and therefore, the motor should remain stationary. If the motors do move or jump, power down the card and check the amplifier and encoder connections. If anomalous behavior is still observed, call PMD or your distributor for application assistance.

2.8.1 Card Reset

During card operations, if at any time you wish to reset the MC73110, you can use the reset button indicated in diagram 2.1 on page 14. Pushing the button will reset the controller.

2.8.2 LED Status Indicators

The MC73110 Developer's Kit card has two LEDs to indicate the status of the board. Once the card has been powered up the green power status LED should light. After the AmplifierDisable output pin is driven to an Amplifier enabled condition, the red LED should light as well. The table below summarizes this:

LED color	Name	Function
Green	Power Status	The green LED is on when the board is powered up and the 3.3V is available.
Red	Amplifier Status	The red LED is on when the amplifier is ready. It is controlled by the AmplifierDisable pin (pin 23) of the MC73110. Normally the red LED will be off after power up. See section 2.10, <i>First Time System Verification</i> , page 19, for more information.

2.9 Software Installation

Locate the CD included in the Developer's Kit. This CD contains software to exercise your board and source code that will enable you to develop your own motion applications. The exercise software is designed to work with Windows 95/98/ME or Windows NT/2000.

If you have autorun enabled, the installation process will start when you insert the CD. The installation program will guide you through installing the software. Upon completion of the installation process, the following components will be installed:

- Pro-Motion - an application for communicating to and exercising the installed Developer's Kit. Refer to section 3, page 21, for operating instructions.
- C-Motion - source code that can be used for developing your own motion applications based on the MC73110. Refer to section 4, page 31, for further information. These files are installed in the "C-Motion" folder, a sub-folder of the installation folder.
- PDF versions of the Developer's Kit manual, programmer's reference and user's guide. The Adobe Acrobat Viewer is required for viewing these files. If the Adobe Acrobat Viewer is not installed on your computer, you can download it from <<http://www.adobe.com>>.

2.10 First Time System Verification

After you have installed the card hardware, made the appropriate connections to your motor, and installed your software, you are ready to perform a simple test that will determine whether your motor is connected correctly. The following procedure should work for the majority of brushless motors, even if the gain parameters may not be optimized for your particular motor. Note that at any time the Pause/Break key can be pressed to disable the servo loops and motor output should the motor start to move erratically or uncontrollably.

- 1 Run Pro-Motion by double clicking the Pro-Motion icon on the desktop.
- 2 If Pro-Motion cannot find the DK Board verify the serial port connections and select the appropriate COM port in the Interface dialog and click OK. Accept the default serial port settings by clicking OK. Refer to section 3.1 Communication for more information.
- 3 If the Axis Wizard pops up click Cancel.
- 4 Select File/Open from the menu and open the StartupTest.pmd file. The parameters will be uploaded to the DK Board and the amplifier will be enabled. Be prepared to hit the Pause/Break key to disable the motor if improper motion is observed.
- 5 The motor should now rotate slowly in either the clockwise or counterclockwise direction. If this occurs, the first time system verification has been completed successfully. If not, recheck the motor connections. If the trouble persists contact PMD or a PMD representative for assistance.

3.0 Using Pro-Motion

In This Section

- Communication
- Axis Wizard
- Main Window

The Pro-Motion program facilitates the exercising of the MC73110. All chip parameters can be viewed and modified via standard Windows controls.

Pro-Motion features:

- Project window for accessing chip parameters via properties dialog boxes.
- Command window for direct text command entry.
- Communications monitor that echoes all commands sent by Pro-Motion to the MC73110.

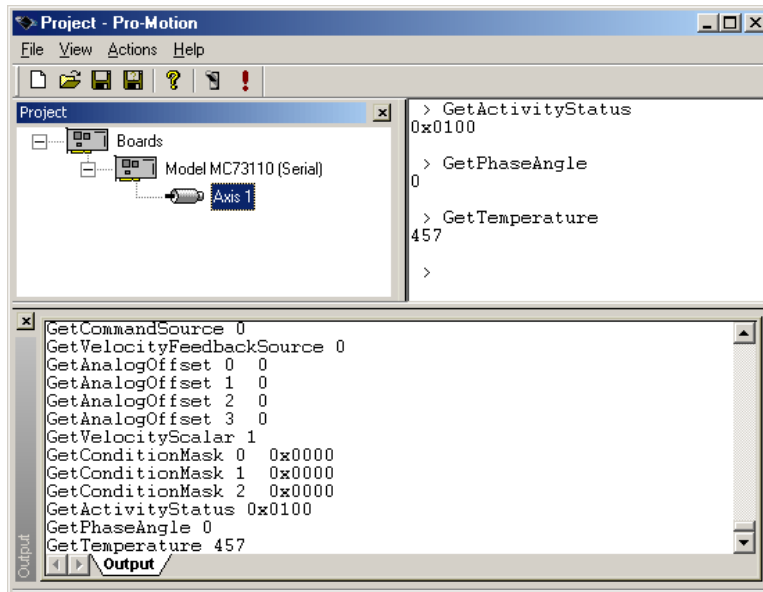

3.1 Communication

When Pro-Motion is started it will attempt to connect to the DK Board via the the serial port using the default serial port settings. If it cannot communicate to the DK Board (or File/New is selected) the Interface selection dialog is displayed. Make sure the interface setting is set to COM port and the selected port is the one the DK Board is attached to.

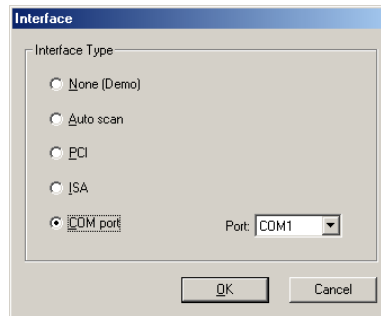

If the serial interface (COM port) is selected in the Interface selection dialog, the serial communication configuration screen is displayed.

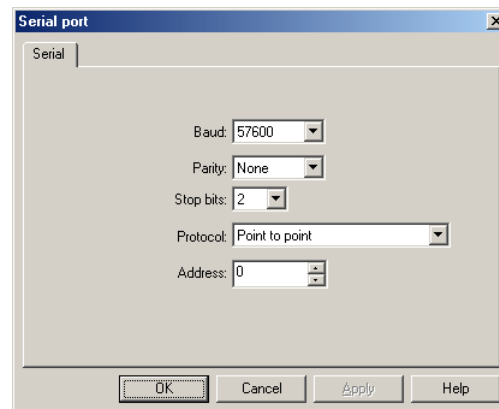

Make sure the serial cable is connected from the host computer's COM port to the DK Board. Set the serial interface parameters according to the default settings of 57600, None, 2, Point to point, 0. Click OK to attempt a connection and proceed to the Axis Setup Wizard. If no connection is made the Interface selection dialog will be displayed again allowing you to modify the interface parameters or run in demo mode.

3.1.1 Axis Setup Wizard

Once communication has been established with the DK Board, the connected motors may be put in motion by setting the appropriate Axis parameters.

When Pro-Motion is run for the first time the Axis Setup Wizard will start automatically to configure the axis. To continue through the configuration process for all of the axis' parameters, click **'Next'**. To accept the default values, click **'Cancel'**.

Individual Axis settings may be modified later via Pro-Motion's **Axis Properties** dialog which is accessed by right-clicking an Axis icon  in the **Project** window and selecting **'Properties'**.

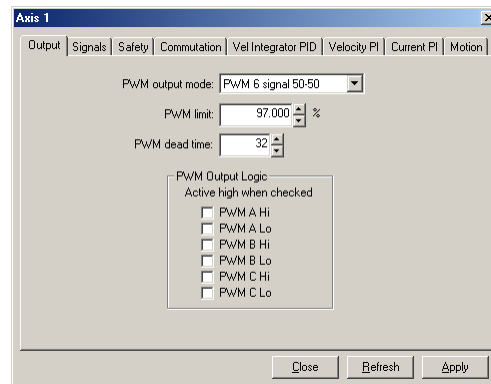

The Axis Setup Wizard may be re-run at any time by selecting **'Axis Wizard'** from Pro-Motion's **View** menu.

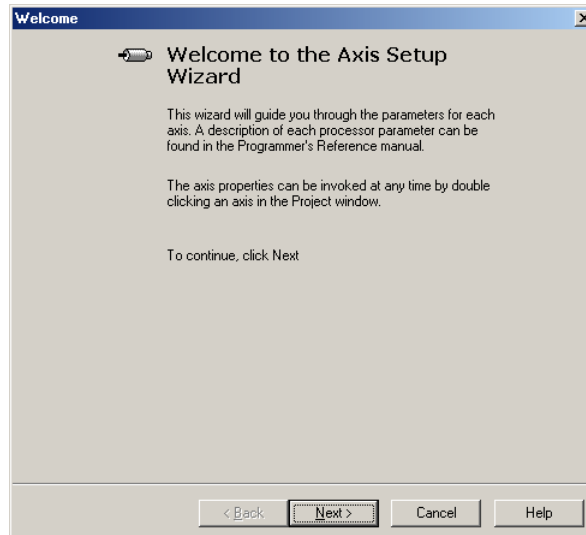

3.1.1 Step # 1: Signal Output Settings

On the Signal Output Settings page of the wizard, select the appropriate **PWM output mode**, **PWM limit**, **PWM dead time** and **PWM output logic** for the amplifier that is connected to the MC73110. The power on default settings are shown below. If you are using the DK Board the **PWM dead time** should be reduced to a value of 32 which translates to 1.6 μ s.

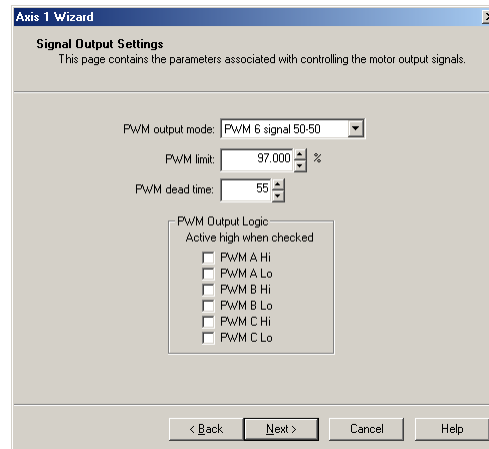

3.1.2 Step #2: Initialize Signal Sensing

This step of the Axis Setup Wizard is used to select the Signal Sense parameters. The default signal sense is active low. Users should check the **Invert sense** checkbox in the first column for any input signals which are active high. The **Event status** column displays and resets the event status bits. The **Activity status** column displays the activity status bits. The controls in this dialog are continually updated.

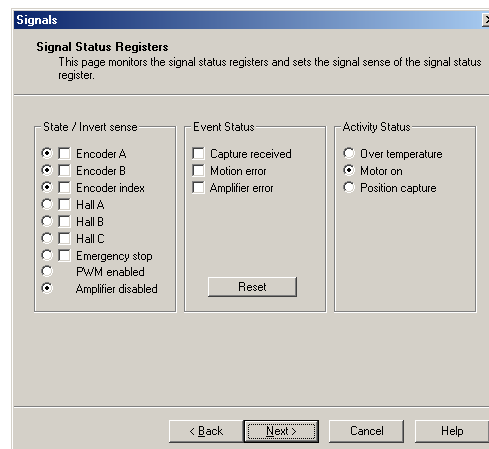

3.1.3 Step #3: Safety Settings

This step of the Axis Setup Wizard is used to set the Safety parameters. The settings as shown in the following figure will:

1. Disable the amplifier if the temperature exceeds 60 °C or the **Emergency stop** signal is set. This particular configuration will latch the amplifier as disabled because the **Amplifier Disable Source** is set to **Amplifier error** which is latched in the Event status register. (see Initialize Signal Sensing)
2. Disable the servo loop if the **Motion error** exceeds 100000.

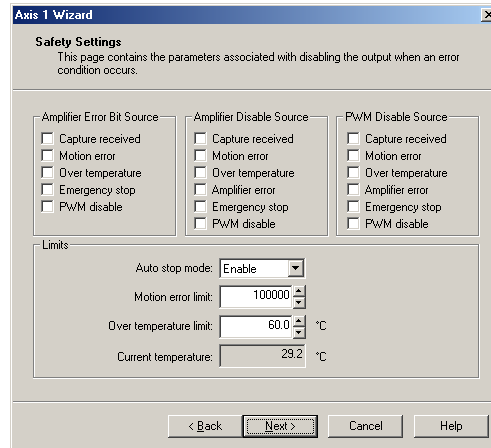

Refer to the *MC73110 Product Manual* for further information on these settings.

3.1.4 Step #4: Commutation

This step of the Axis Setup Wizard is used to set the Commutation parameters. If the Commutation mode is set to **Sinusoidal**, the motor will commutate in hall-based mode until a hall signal transition occurs. The **phase angle** parameter is read-only and cannot be set in the dialog. However, it can be set in the command window using the SetPhaseAngle command. Please see the *MC73110 Product Manual* for further information on phase initialization.

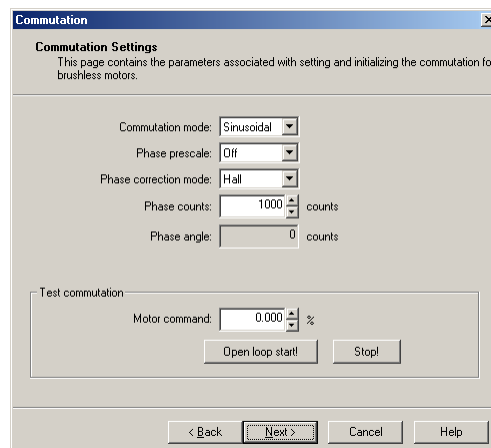

3.1.4.1 Step #4a: Check Commutation

The commutation may be verified by running the motor in open loop mode. Set the motor command parameter to a low value between 1% and 15%, keeping in mind that the motor may start to move at a rate proportional to the motor command setting. Click the **Open loop start** button. If the motor is commutating properly, smooth, continuous motion should occur in a single direction. Click the **Stop** button to stop motion. If the motor does not move or motion is erratic verify that **Phase counts** and **signal sense** is set correctly. The **signal sense** can be accessed by going back to the **Signals** page.

3.1.5 Step #5: Velocity Integrator Loop Parameters

This step of the Axis Setup Wizard is used to select the Velocity Integrator Loop parameters.

The screenshot shows the 'Velocity Integrator Loop' dialog box within the 'Axis 1 Wizard'. The dialog has a title bar with 'Axis 1 Wizard' and a close button. Below the title bar, the text reads: 'Velocity Integrator Loop. This page contains the parameters associated with the velocity integrator feedback loop. Set the proportional (Kp) and integral (Ki) coefficients to a low value to start. The integration limit must be non-zero for the Ki parameter to have any affect.' The parameters are: Kp: 10, Ki: 5, Integration limit: 1000 count x cycles, and Kd: 10. At the bottom, there are four buttons: '< Back', 'Next >', 'Cancel', and 'Help'.

3.1.6 Step #6: Velocity Loop Parameters

This step of the Axis Setup Wizard is used to select the Velocity Loop parameters.

The screenshot shows the 'Velocity Loop' dialog box within the 'Axis 1 Wizard'. The dialog has a title bar with 'Axis 1 Wizard' and a close button. Below the title bar, the text reads: 'Velocity Loop. This page contains the parameters associated with the velocity feedback loop. Set the proportional (Kp) and integral (Ki) coefficients to a low value to start. The integration limit must be non-zero for the Ki parameter to have any affect.' The parameters are: Kp: 10, Ki: 5, Integration limit: 1000 count x cycles, Velocity feedback source: Encoder (dropdown menu), and Analog feedback offset: 0. At the bottom, there are four buttons: '< Back', 'Next >', 'Cancel', and 'Help'.

3.2.6 Step #7: Current Loop Parameters

This step of the Axis Setup Wizard is used to select the Current Loop parameters.

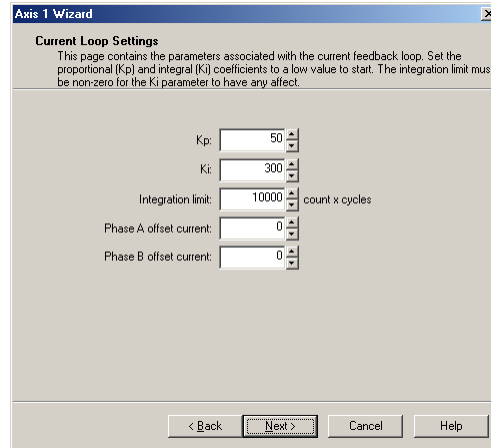

3.2.7 Step #8: Miscellaneous Settings

The **Miscellaneous Settings** page contains the parameters for controlling the servo loops and motor dynamics. The power-on default settings are shown in the following figure. When **Motor Mode** is off all the loops are disabled (open loop mode) and **Motor command** controls the motor speed. The dynamics settings have no effect in this mode.

When the **command** source is set to **Analog** the command for the velocity or current loops originates from the analog input signal. When set to **SPI** the command for the velocity or current loops is a 16-bit value read from the incoming SPI data stream. When set to **Profile Generator** the command is generated internally based on the **Velocity** and **Acceleration** parameters.

Click the **Finish** button to update the motion processor parameters.

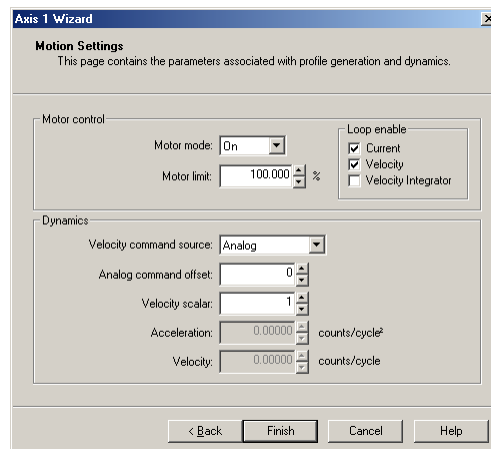

3.2 Main Window

The main window is comprised of 3 subwindows, the project window, the command window and the output window. The workspace and output windows are control bars which can be docked and resized at any location in the main window or undocked and moved anywhere on the desktop. They can be removed by clicking on the X. To re-display them, select the appropriate View menu item.

There are a couple of keyboard shortcuts that can be used at any time:

- the Pause/Break key will disable the servo loops and motor output by setting MotorMode to 0 and MotorCommand to 0.
- the Scroll Lock key will start and stop the output window from displaying communication activity.

3.2.1 Project Window

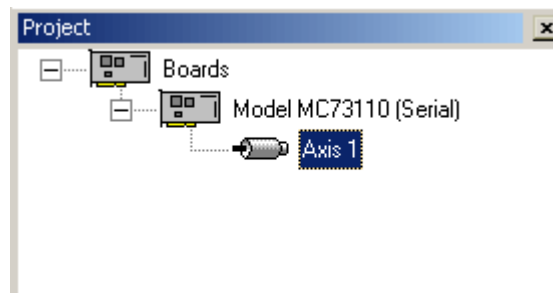

The Project window displays the available DK Board's and axes in a tree format. Double-clicking on a board or axis will display the properties dialog for that item.

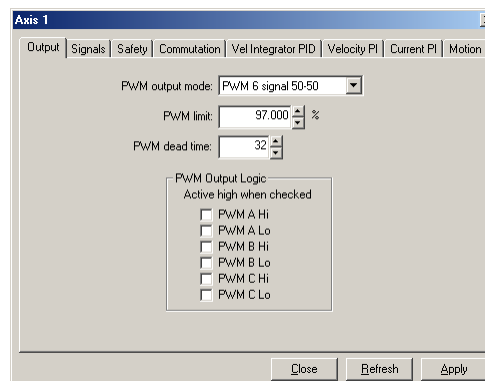

3.2.2 Command Window

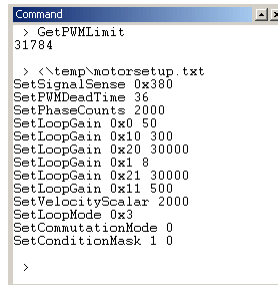

```

Command
> GetPWMLimit
31784
> <\temp\motorsetup.txt
SetSignalSense 0x380
SetPWMDeadTime 36
SetPhaseCounts 2000
SetLoopGain 0x0 50
SetLoopGain 0x10 300
SetLoopGain 0x20 30000
SetLoopGain 0x1 8
SetLoopGain 0x21 30000
SetLoopGain 0x11 500
SetVelocityScalar 2000
SetLoopMode 0x3
SetCommutationMode 0
SetConditionMask 1 0
>

```

The Command window in Pro-Motion allows you to issue commands directly to the MC73110. The window has a command line style interface that accepts all of the MC73110 commands. The *MC73110 Programmer's Reference* contains a full list of commands, along with their required parameters. The command window presents you with the command prompt '>'. The following sequence shows a typical command session:

```

> Reset
Processor reset
> SetSignalSense 0x380
> SetPWMDeadTime 36
> SetPhaseCounts 2000
> SetLoopGain 0x0 50
> SetLoopGain 0x10 300
> SetLoopGain 0x20 30000
> SetVelocityScalar 2000

```

The Command window is not case-sensitive, so commands can be entered in any combination of upper and lower case characters. As shown above, commands are entered as a sequence of command name followed by up to 2 numeric parameters. Parameters can represent a single 16-bit word of data or a 32-bit double word of data, depending on what is required by the particular command.

```
> SetLoopGain 1 300
```

In this example, the first parameter represents a 16-bit word that contains the selected loop gain, and the second parameter represents a 32-bit word that contains the loop gain value.

All of the "Get" commands display the value returned by the chipset.

```
> GetEventStatus
0x0309
```

Some commands require a parameter for selecting the desired value.

```
> GetLoopGain 16
3000
```

In this example, 16 selects the loop gain number for which the value is retrieved. The Command window accepts numeric parameters in either decimal or hexadecimal format. Pre-fixing a numeric parameter with "0x" enters that number using hexadecimal format.

```
> GetLoopGain 0x10  
3000
```

Pressing the Tab key at any time will display a list of available commands depending what is already typed in the command window. If nothing is typed in the command window then all of the available commands are displayed. If, for example, “geta” is typed in the command window then the list will contain all the commands starting with “geta”.

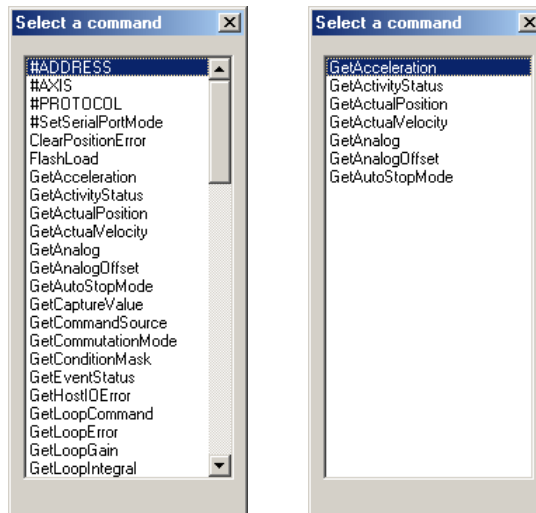

4.0 Developing Your Own Applications with C-Motion

In This Section Theory of Use

C-Motion is a “C” source code library that contains all the code required for communicating to the Motor Control processor using the serial interface.

C-Motion includes the following features:-

- Axis virtualization
- The ability to communicate to multiple PMD motion processors
- Can be easily linked to any “C/C++” application
- Supports serial communication

The following files make up the C-Motion distribution:

C-Motion.h/C-Motion.c	Definition/declaration of the processor command set
PMDw32ser.h/PMDw32ser.c	Windows serial communication interface functions
PMDutil.h/PMDutil.c	General utility functions
PMDtrans.h/PMDtrans.c	Generic transport (interface) functions
PMDdecode.h	Defines the processor and C-Motion error codes
PMDocode.h	Defines the control codes for processor commands
PMDtypes.h	Defines the basic types required by C-Motion

C-Motion can be linked to your application code by including the above “C” source files in your application. Then, for any application source file that requires access to the motion processor #include “C-Motion.h”.

4.1 Theory of Use

C-Motion is a set of functions that encapsulate the motion processor command set. Every command has as its first parameter an “axis handle”. The axis handle is a structure containing information about the interface to the motion processor and the axis number that the handle represents. Before communicating to the motion processor, the axis handle must be initialized using the following sequence of commands:

```
// the axis handle
PMDAxisHandle handle;
// open serial interface to PMD processor and initialize handle to axis one
PMDSetupAxisInterface_Serial( &handle, PMDAxis1, 1 ); // COM1
```

Once the axis handle has been initialized, any of the motion processor commands can be executed. C-Motion.h includes the prototypes for all motion processor commands as implemented in C-Motion. Refer to this file for the required parameters for each command. The *MC73110 Product Manual* is the primary source for information about the operation and purpose of each command.

Every C-Motion processor command returns a status code of type PMDresult. The return code for every command executed should be checked before attempting to execute more commands.

```
PMDresult result,status;

result = PMDSetVelocity(&handle, 100000);

if (result != PMD_ERR_OK)
{
    printf("Error:%s\n",PMDGetErrorMessage(result));
    return;
}
```

Many commands require additional parameters. Some standard values are defined by C-Motion and can be used with the appropriate commands. Refer to PMDtypes.h for a complete list of defined types. An example of calling one of the C-Motion functions with the pre-defined types is shown below.

```
PMDSetConditionMask(&handle, PMDCConditionMaskAmpDisable, PMDCConditionOverTemp);
```

In addition to the processor commands, C-Motion provides several support functions. A subset of these are:

```
void PMDCloseAxisInterface(PMDAxisHandle* axis_handle);
```

should be called to terminate an interface connection.

```
char *PMDGetErrorMessage(PMDresult errorCode);
```

returns a character string representation of the corresponding PMD chip or C-Motion error code.

```
void GetCMotionVersion(PMDuint8* MajorVersion, PMDuint8* MinorVersion);
```

returns the major and minor version number of C-Motion.

5.0 MC73110

Electrical Reference

In This Section

- User-Settable Jumper Options
- Connecting to the Card

5.1 User-Settable Jumper Options

The following table shows the user-settable jumper options for the MC73110 Developer's Kit card. For jumper locations see the diagram on the following page.

Jumper	Jumper setting	Description
JP1, JP2	1-2	Selects RS-232 communication using on-board transceiver. This is the default position of this jumper.
	2-3	Selects RS-485 communication using user-provided daughtercard. For a complete description of the electrical requirements of this daughtercard, see section 5.2.3, <i>RS-485 Communications</i> , page 39.
	3-4	Reserved
JP3-JP5	1-2	Reserved, must be set to 1-2
JP6, JP7	1-2	Selects use of on board amplifier/switcher. This is the default setting.
	2-3	Selects use of remote amplifier/switcher. This setting is useful to verify custom amplifier design or to connect to more powerful switching blocks .
JP9, JP10	1-2	Reserved, must be set to 1-2

In addition, the following resistor pack should be installed depending on whether single or differential quadrature encoders are used.

Resistor pack	How to set	Description
J8	Installed <i>this is the default setting</i>	If you are using differential connections leave the resistor pack installed.
	Removed	If you are using single-ended encoder connections, remove the resistor pack.

Figure 5-1.
Location of
various board
elements

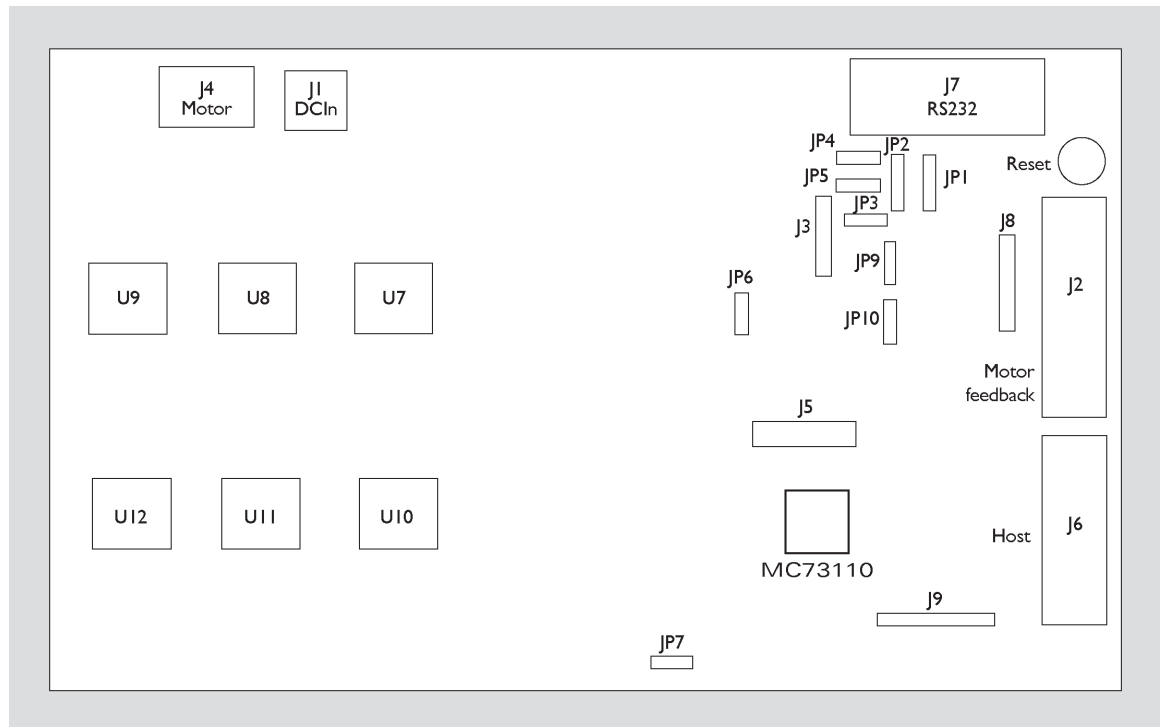

5.2 Connecting to the Card

There are a total of seven connectors that can be used with the MC73110 Developer's Kit card as follows:

Connector	Name	Function
J1	Power	Provides operating power to the developer's kit card.
J2	Motor feedback	Inputs various motor-related signals.
J3	RS-485	Provides communication to/from the card when a multi-drop RS485 is used.
J4	Motor	Provides high voltage, high current connections to the motor from the amplifier output.
J5	Remote switcher	Inputs and outputs various signals for use with a remote switching block.
J6	Host	Inputs and outputs various non-motor command and feedback signals to/from the developer's kit card.
J7	Serial port	Provides RS-232 communication to/from the card using an on-card transceiver driver chip. This connector is designed to interface without null-modem or other changes to a DB-9 PC serial port.

Here is a summary of the connector types expected for these 7 connectors:

Connector	Signal type	# pins	Type
J1	High power	2	Through-hole terminal block (screw connection)
J2	Low power digital & analog	14	Side-facing single row shrouded header (1-in-line 0.100" pitch friction lock header)
J3	Low power digital	5	1-in-line 0.100" pitch header
J4	High power	3	Through-hole terminal block (screw connection)
J5	Low power digital & analog	16	8 x 2 vertical header (2mm pitch)
J6	Low power digital & analog	12	Side-facing single row shrouded header (1-in-line 0.100" pitch friction lock header)
J7	Low power digital	9	Side-facing D-sub 9 (female)

5.2.1 Power Connector (J1)

The power connector provides power to the card. All other voltages used by the card are derived from this central supply using an on-card DC-DC converter. The voltage provided at these connections matches the voltage at which the motor will be driven.

Pin #	Signal name	Description
1	V+	18 - 48V. Current capacity specification should be maximum motor drive + lamp (to power the card)
2	PowerGnd	Ground return for V+

5.2.2 Motor Feedback Connector (J2)

The motor feedback connector inputs various motor-related signals to the developer's kit card. All these signals are low power, low voltage digital or analog signals.

Pin #	Signal	Description
1	+5V	This signal provides 5V. This is often useful to power the encoder circuitry.
2	GND	This signal provides the digital return.
3	QuadA+	This input signal provides the high side of the differential quadrature input for encoder phase A. For more information on connecting encoders see <i>section 2.6, Preparing the Card for Installation, page 14</i> . If unused this signal may be left unconnected.
4	QuadA-	This input signal provides the low side of the differential quadrature input for encoder phase A. When using a single-ended encoder, this pin should be left unconnected. For more information on connecting encoders see <i>section 2.6, Preparing the Card for Installation, page 14</i> . If unused this signal may be left unconnected.
5	QuadB+	This input signal provides the high side of the differential quadrature input for encoder phase B. For more information on connecting encoders see <i>section 2.6, Preparing the Card for Installation, page 14</i> . If unused this signal may be left unconnected.
6	QuadB-	This input signal provides the low side of the differential quadrature input for encoder phase B. When using a single-ended encoder, this pin should be left unconnected. For more information on connecting encoders see <i>section 2.6, Preparing the Card for Installation, page 14</i> . If unused this signal may be left unconnected.
7	Index+	This input signal provides the high side of the differential quadrature input for the Index signal. For more information on connecting encoders see <i>section 2.6, Preparing the Card for Installation, page 14</i> . If unused this signal may be left unconnected.
8	Index-	This input signal provides the low side of the differential quadrature input for the Index signal. When using a single-ended encoder, this pin should be left unconnected. For more information on connecting encoders see <i>section 2.6, Preparing the Card for Installation, page 14</i> . If unused this signal may be left unconnected.
9	GND	This signal provides the digital return.
10	HallA	These signals are the Hall sensor inputs. For logic "0", the signal should be lower than 0.5V; for logic "1", the signal should be greater than 1.5V.
11	HallB	
12	HallC	
13	TachIn+	This is the positive input signal for the analog tachometer signal. This signal represents the instantaneous speed of the motor. The input range is +/- 60V. If unused this signal may be left unconnected.
14	TachIn- (GND)	This is the negative input for the analog tachometer signal. The input range is +/- 60V. If unused this signal may be left unconnected.

5.2.3 RS485 Connector (J3)

This connector provides communication to/from the card when a multi-drop RS485 is to be used. All these signals are low power, low voltage digital or analog signals. The connector that will be used matches the serial connector on our current DK card.

Pin #	Signal	Description
1	SrIXmt	This signal provides a serial transmit connection for RS485 communications
2	SrIRcv	This signal provides a serial receive connection for RS485 communications
3	SrIEnable	This signal provides a serial enable connection for RS485 communications
4	GND	Ground
5	Vcc	+5V Vcc provided by card.

5.2.4 Motor Connector (J4)

The motor connector provides the high voltage 3-phase outputs from the amplifier/switcher to the motor.

Pin #	Signal	Description
1	MotorC	Leg 3 of 3 motor coil connections
2	MotorB	Leg 2 of 3 motor coil connections
3	MotorA	Leg 1 of 3 motor coil connections

5.2.5 Remote Switcher Connector (J5)

The remote switcher connector inputs and outputs various signals that make it possible for the user to develop a separate switching block, while still using the digital logic of the DK card to power the motor control IC.

Signal	Pin #	Description
AmplifierEnable	1	This signal is connected to the AmplifierDisable signal from MC73110. It can be programmed to go inactive under certain erroneous MCP conditions
PWMOutputDisable	2	This signal provides a digital input connected to the MC73110 pin of the same name. A high level on this signal indicates that PWMOutputDisable is not active, a low indicates it is active.
I ₂ CClk	3	This signal connects to the remote switcher's temperature sensor I ₂ C clock connection.
I ₂ Cdata	4	This signal connects to the remote switcher's temperature sensor I ₂ C data connection.
PWMCHigh/PWMC	5	These signals connect to the PWM drive signals of the same name at the MC73110.
PWMLow	6	
PWMBHigh/PWMB	7	
PWMLow	8	
PWMAHigh/PWMA	9	
PWMALow	10	
+3.3V	11	+3.3V power for digital logic
AGND	12	These signals are analog returns.
	13	
	14	
CurrentA	15	These analog input signals hold the instantaneous current through phase A and phase B of the motor coils. The input voltage range is 0 to 3.3V, referenced at to 1.65V.
CurrentB	16	

5.2.6 Host Connector (J6)

The Host connector inputs and outputs various non-motor related signals to/from the developer's kit card.

Pin #	Signal	Description
1	Estop	This digital input provides an emergency stop signal to the developer's kit card. Although its function and interpretation are programmable, normally a high signal (greater than 1.5V) indicates an emergency stop is not active; and a low signal (less than .5V) indicates that it is active. If unused this signal may be left unconnected.
2	AmplifierDisable	This digital output signal provides a programmable output signal indicating the internal state of the MC73110. Normally, a low output indicates an error, while a high signal indicates no error. In addition to being an output at this connector, this signal is also used internally by the MC73110 developer's kit card to shut down the amplifier's switchers when the amplifier operates in 'internal switcher' mode.
3	GND	This signal provides a digital ground return.
4	DigitalCmdClk	This digital input signal provides the SPI datastream 'clock' signal.
5	DigitalCmdData	This digital input signal provides the SPI datastream 'data' signal
6	GND	This signal provides a digital ground return.
7	+5V	This signal outputs provides 5V to external circuitry.
8	n.c.	—
9		
10	AnalogCmd+	This analog input signal provides the positive input of the analog command. Depending on how the MC73110's control loop has been programmed, this signal represents the desired voltage, torque or velocity. The input range is +/-10V. The reference input can be differential or single-ended.
11	AnalogCmd-	This analog input signal provides the negative input of the analog command. Depending on how the MC73110's control loop has been programmed, this signal represents the desired voltage, torque or velocity. The input range is +/-10V. The reference input can be differential or single-ended. When it is single-ended, AnalogCmd- must be connected to AGND, pin 12.
12	AGND	This signal provides an analog ground return

5.2.7 Serial Port Connector (J7)

The RS-232 serial connector provides communication to/from the card using an on-card transceiver driver chip. This connector is designed to interface without null-modem or other changes to the DB-9 PC serial port. These signals are low power, low voltage digital or analog signals.

Pin #	Signal	Description
2	SrIXmt	Serial transmit signal from the MC73110 Developer's Kit transceiver chip.
3	SrIRcv	Serial receive signal to the MC73110 Developer's Kit card.
5	GND	Ground

Performance Motion Devices, Inc.
55 Old Bedford Road
Lincoln, MA 01733