

FIBER OPTIC TRANSCEIVING MODULE

TODX298

FIBER OPTIC TRANSCEIVING MODULE WITH ANALOG OUTPUT TO MONITOR OPTICAL FLUX FOR DUPLEX DIGITAL SIGNAL TRANSMISSION

- Data rate: DC to 8 Mb / s (NRZ code)
- Transmission distance: Up to 1000 m
- TTL interface
- LED is driven by Differential circuit.
- ATC (Automatic Threshold Control) circuit is used for stabilized output at wide range of optical power level.
- No need to change a resistor according to transmission distance.

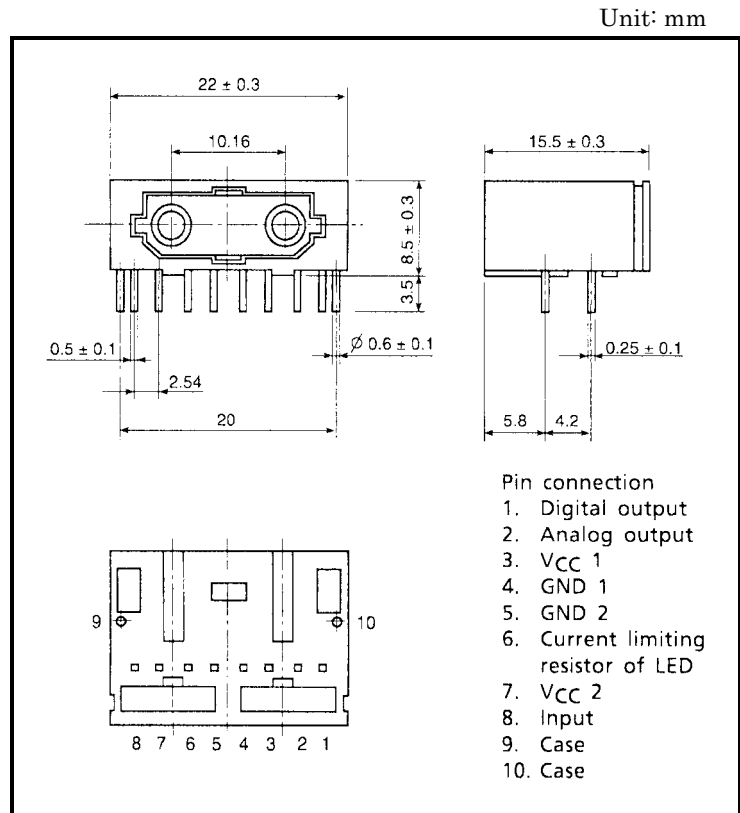

1. Maximum Ratings (Ta = 25°C)

Characteristics	Symbol	Ratings	Unit
Storage Temperature	T _{stg}	-40 to 85	°C
Operating Temperature	T _{opr}	-40 to 85	°C
Supply Voltage	V _{CC}	-0.5 to 7	V
Input Voltage	V _{IN}	-0.5 to V _{CC} + 0.5	V
High Level Output Current	I _{OH}	-1	mA
Low Level Output Current	I _{OL}	20	mA
Soldering Temperature	T _{sol}	260 (Note 1)	°C

Note 1: Soldering time ≤ 3 s (More than 1 mm apart from the package).

Handling precaution: The LEDs used in this product contain GaAs (Gallium Arsenide). Care must be taken to protect the safety of people and the environment when scrapping or terminal processing.

2. Recommended Operating Conditions

Characteristics	Symbol	Min	Typ.	Max	Unit
Supply Voltage	V_{CC}	4.75	5.0	5.25	V
High Level Input Voltage	V_{IH}	2.0	—	V_{CC}	V
Low Level Input Voltage	V_{IL}	0	—	0.8	V
High Level Output Current	I_{OH}	—	—	-60	μ A
Low Level Output Current	I_{OL}	—	—	1.2	mA
Load Resistance (Note 2)		—	10	—	k Ω
Load Capacity (Note 2)		—	10	—	pF

Note 2: Load of analog output.

3. Electrical and Optical Characteristics (Ta = 25°C, VCC = 5 V)

Characteristics	Symbol	Test Condition	Min	Typ.	Max	Unit
Data Rate		NRZ Code (Note 3)	DC	—	8	Mb / s
Transmission Distance		Using PCF (Note 4)	0.2	—	1000	m
Pulse Width Distortion (Note 5)	Δtw	Pulse width 125 ns Pulse cycle 250 ns $C_L = 10$ pF	-42	—	42	ns
Fiber Output Power (Note 6)	P_f	$R = 1.2 \Omega$	-20	—	-14	dBm
Maximum Receivable Power (Note 7)	P_{MAX}	8 Mb / s, Using PCF (Note 4)	-14	—	—	dBm
Minimum Receivable Power (Note 7)	P_{MIN}	8 Mb / s, Using PCF (Note 4)	—	—	-29	dBm
Current Consumption	I_{CC}	$R = 1.2 k\Omega$	—	75	90	mA
Analog Output Voltage (Note 8)	V_{OA}	$P_{IN} = -14$ dBm	3.4	3.8	4.5	V
		$P_{IN} = -29$ dBm	1.3	1.5	2.0	V
		$P_{IN} = -\infty$ dBm	1.0	1.3	—	V
High Level Input Voltage	V_{IH}		2.0	—	—	V
Low Level Input Voltage	V_{IL}		—	—	0.8	V
High Level Output Voltage	V_{OH}		4.6	—	—	V
Low Level Output Voltage	V_{OL}		—	—	0.5	V

Note 3: LED is on when input signal is high level, it is off when low level.

High level output when optical flux is received. Low level output when it is not received.

Note 4: Plastic cladding silica fiber (200 / 300 μ m).

Note 5: Between input of TODX298 and digital output of TODX298.

Note 6: Measure with a standard optical fiber with fiber optic connectors. Valued by peak.

Note 7: $BER \leq 10^{-9}$, Valued by peak.

Note 8: When input signal DC.

4. Example of Typical Characteristics

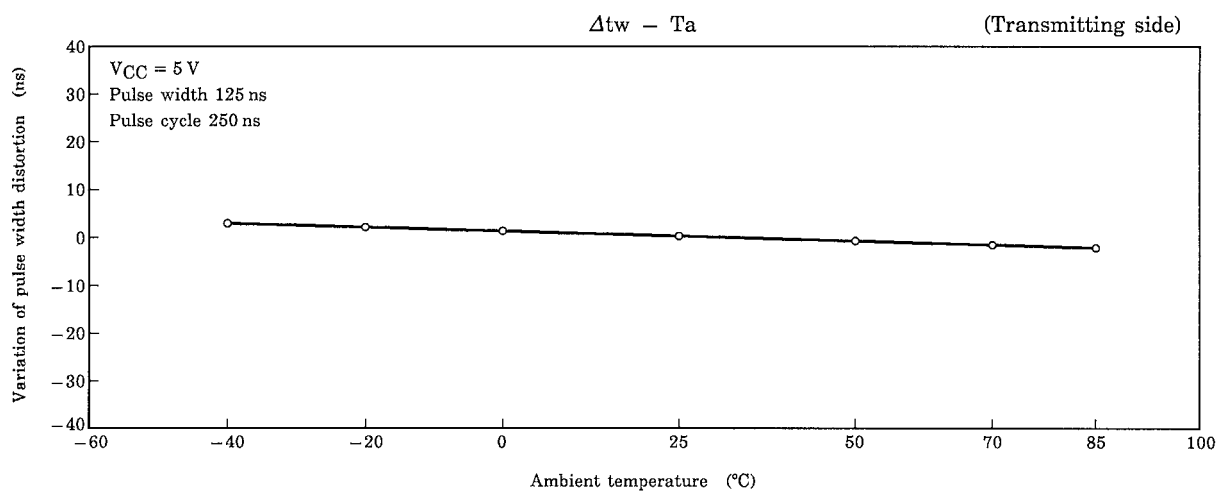
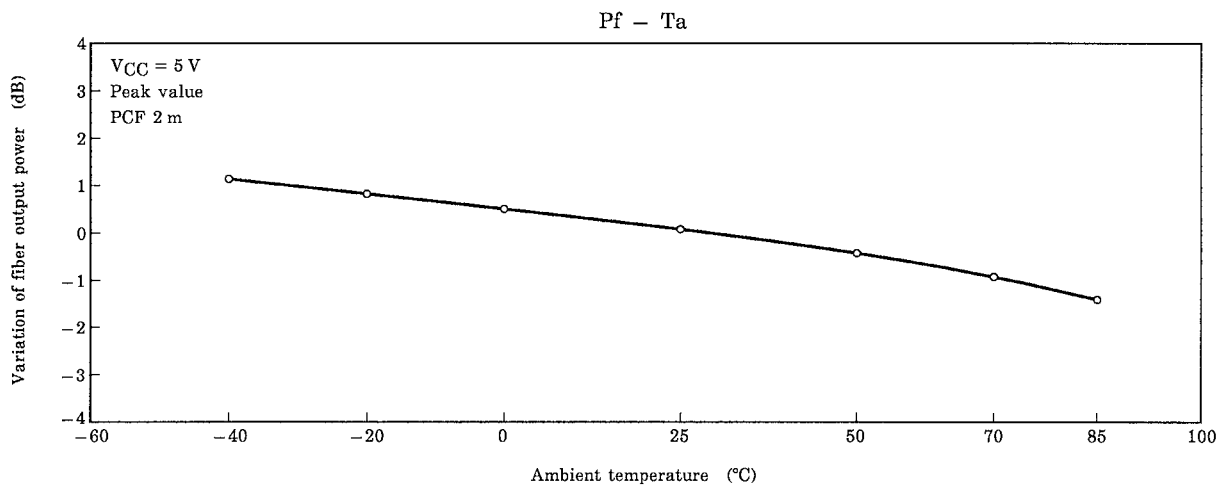
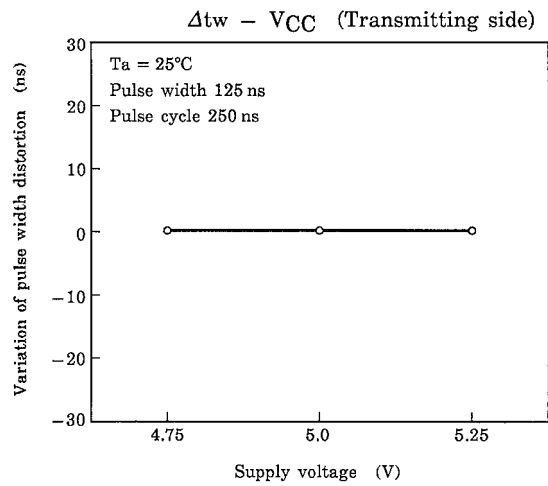
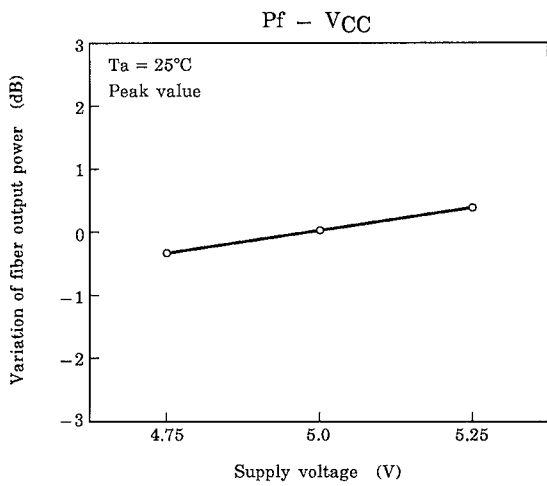

Note 9: There give characteristic examples, and its values are not guaranteed.

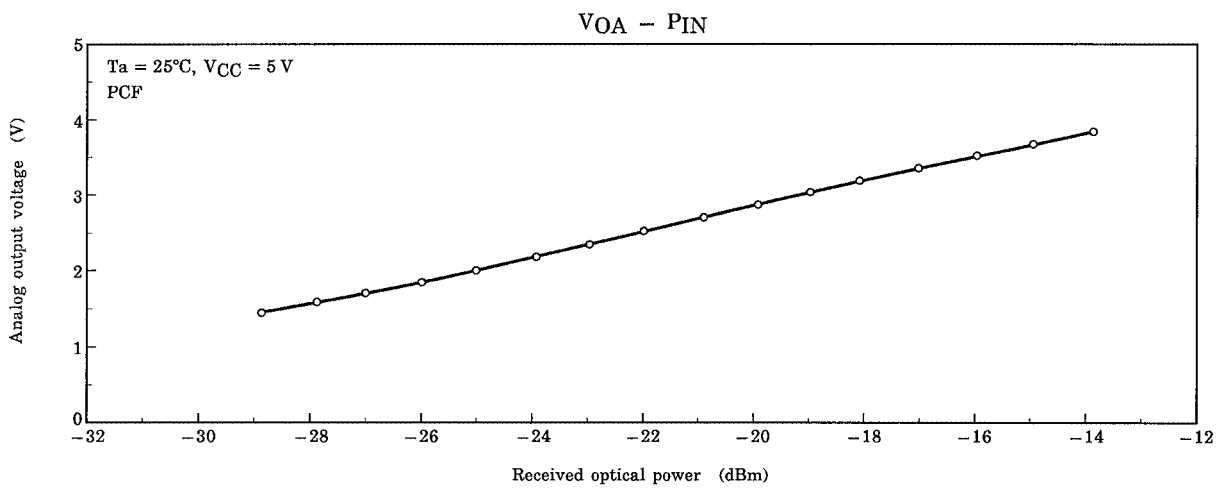
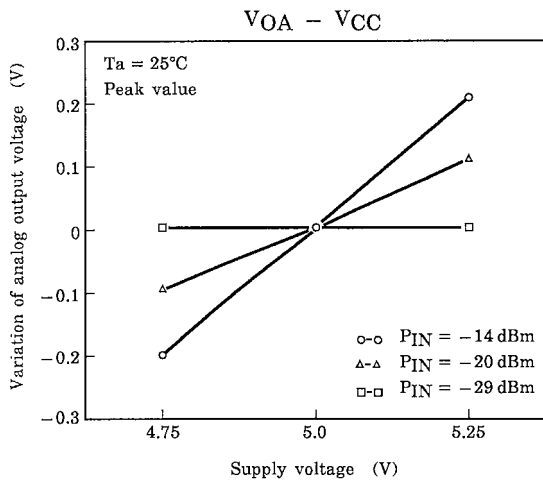

Note 9: There give characteristic examples, and its values are not guaranteed.

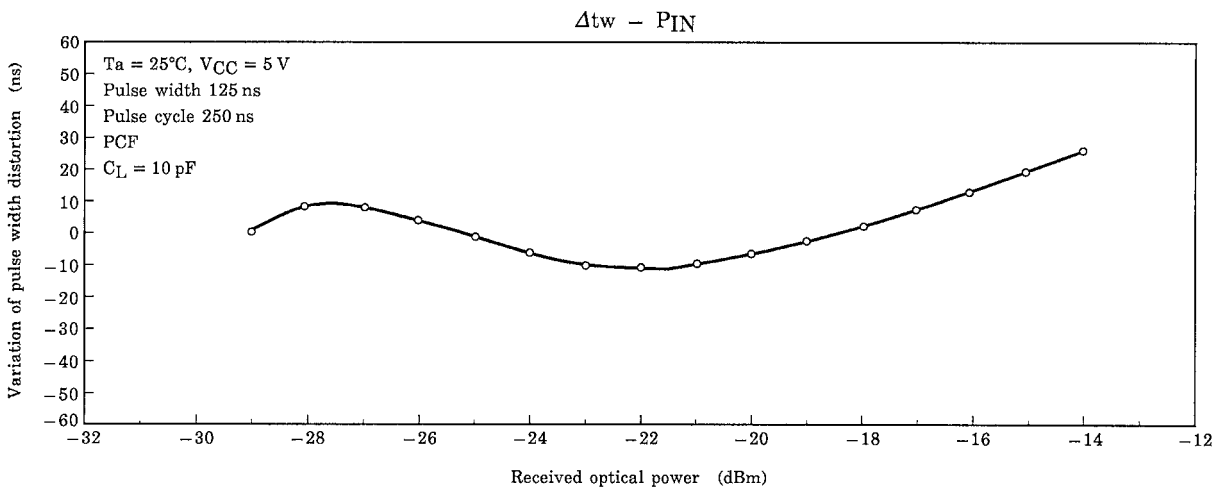
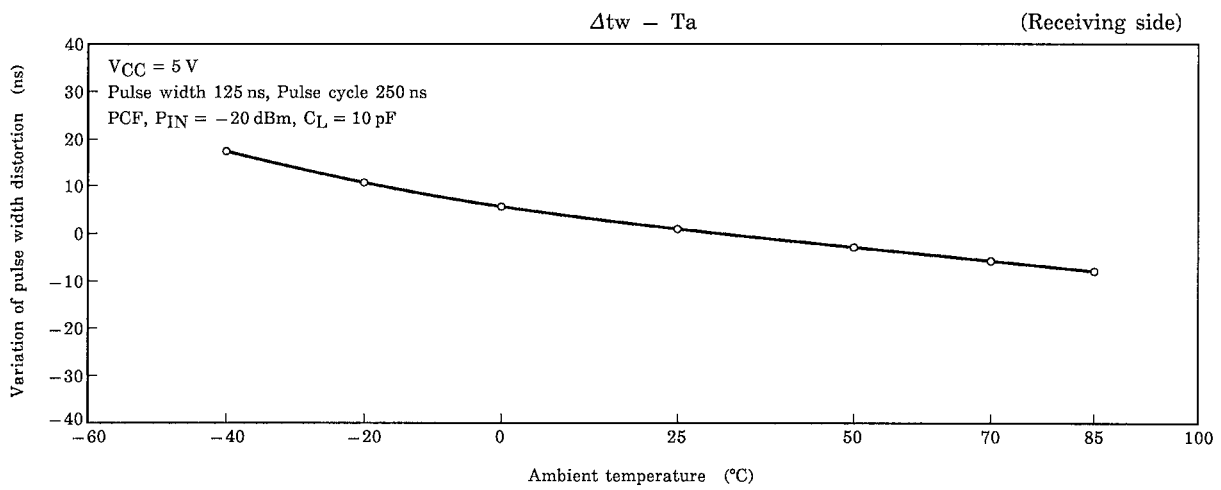
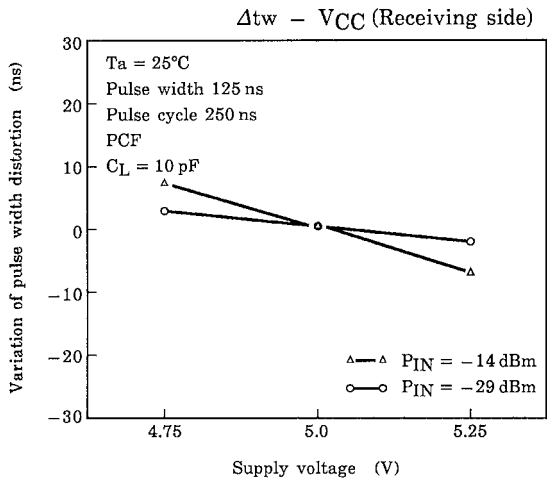

Note 9: There give characteristic examples, and its values are not guaranteed.

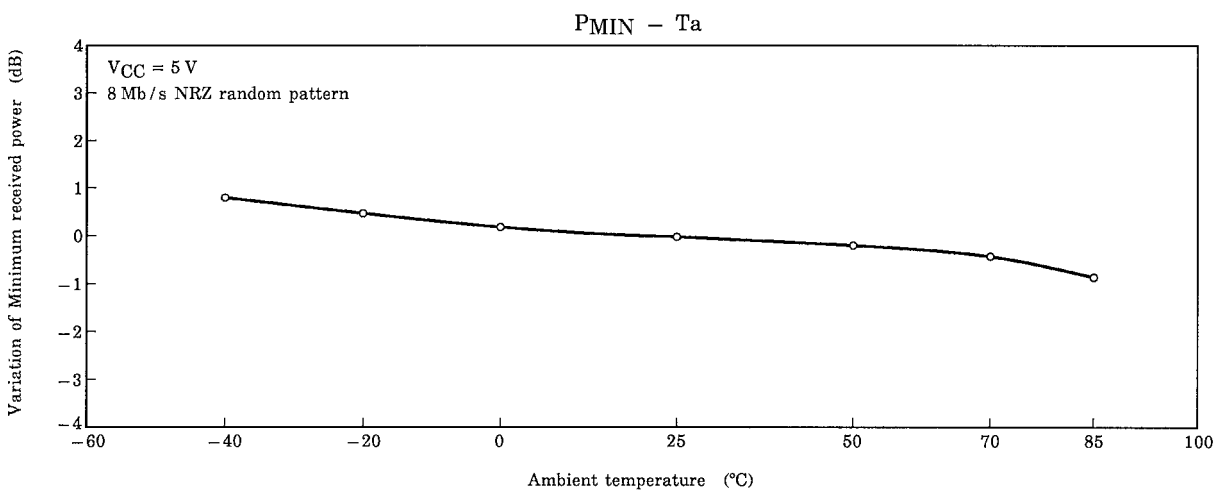
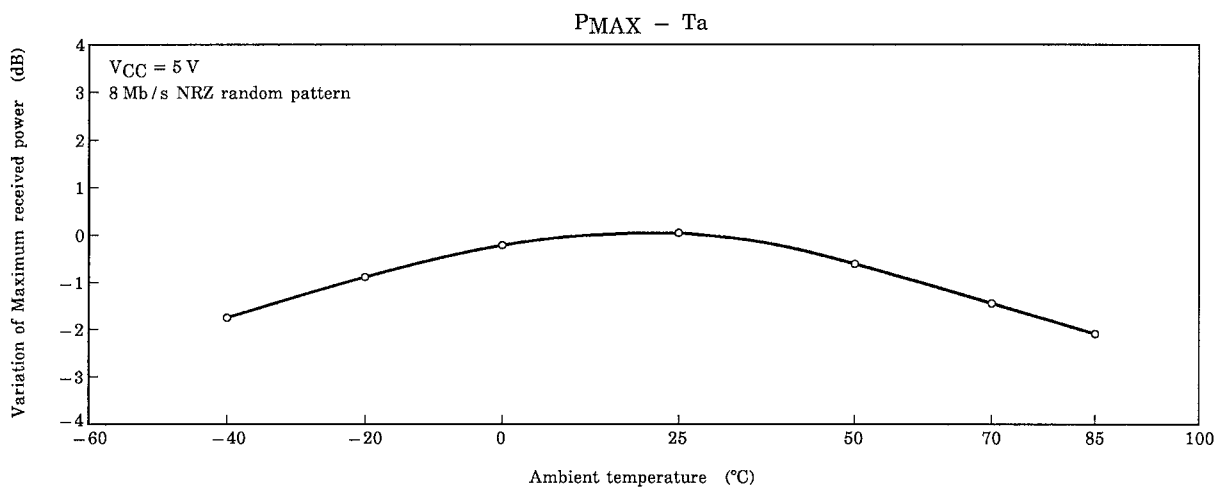
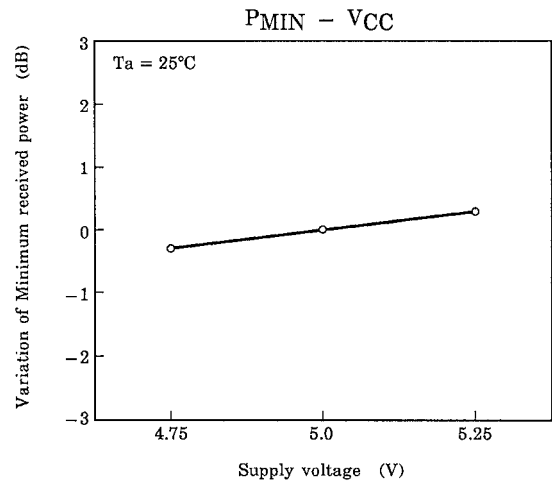
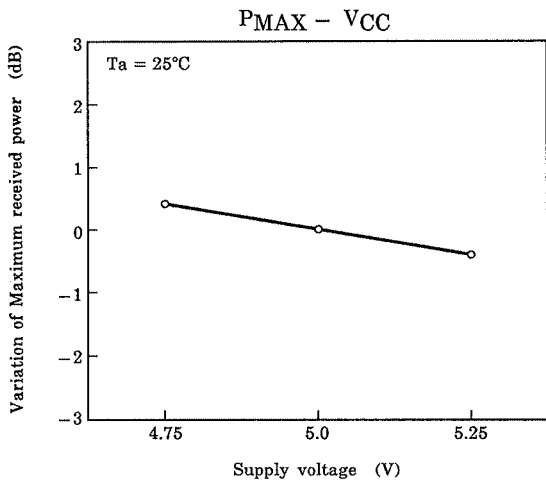

Note 9: There give characteristic examples, and its values are not guaranteed.

5. Application Circuit

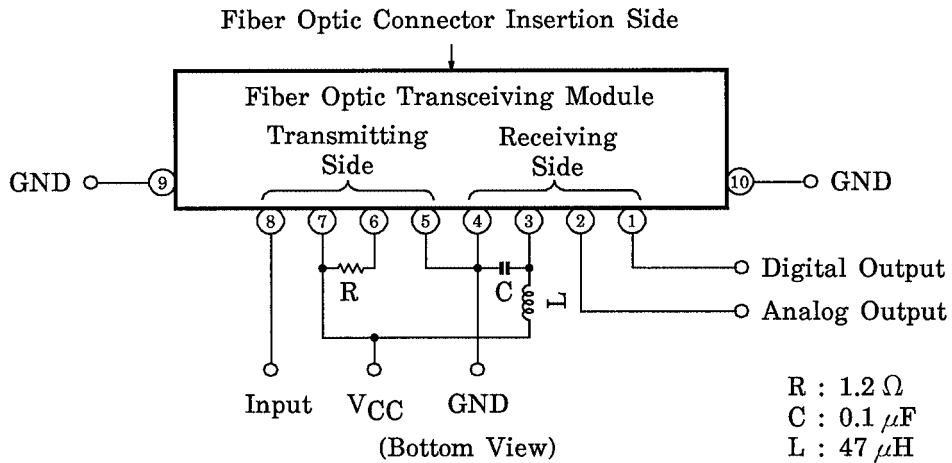

Fiber Optic Connector Type Name	Transmission Distance (m)
TOCP200Q-□□B TOCP200X-□□B	0.2 to 1000

6. Applicable Optical Fiber with Fiber Optic Connectors

TOCP200Q-□□B, TOCP200X-□□B

7. Precaution on Use

(1) Maximum rating

The maximum ratings are the limit values which must not be exceeded during operation of device. None of these rating value must not be exceeded. If the maximum rating value is exceeded, the characteristics of devices may never be restored properly. In extreme cases, the device may be permanently damages.

(2) Lifetime of light emitters

If an optical module is used for a long period of time, degeneration in the characteristics will mostly be due to a lowering of the fiber output power (Pf). This is caused by the degradation of the optical output of the LEDs used as the light source. The cause of degradation of the optical output of the LEDs may be defects in wafer crystallization or mold resin stress. The detailed causes are, however, not clear.

The lifetime of light emitters is greatly influenced by the operating conditions and the environment in which it is used as well as by the lifetime characteristics unique to the device type. Thus, when a light emitting device and its operating conditions determined, Toshiba recommend that lifetime characteristics be checked.

Depending on the environment conditions, Toshiba recommend that maintenance such as regular checks of the amount of optical output in accordance with the condition of operating environment.

(3) Soldering

Optical modules are comprised of internal semiconductor devices. However, in principle, optical modules are optical components. During soldering, ensure that flux does not contact with the emitting surface or the detecting surface. Also ensure that proper flux removal is conducted after soldering. Some optical modules come with a protective cap. The protective cap is used to avoid malfunction when the optical module is not in use. Note that it is not dust or waterproof.

As mentioned before, optical modules are optical components. Thus, in principle, soldering where there may be flux residue and flux removal after soldering is not recommended. Toshiba recommend that soldering be performed without the optical module mounted on the board. Then, after the board has been cleaned, the optical module should be soldered on to the board manually.

If the optical module cannot be soldered manually, use non-halogen (chlorine-free) flux and make sure, without cleaning, there is no residue such as chlorine. This is one of the ways to eliminate the effects of flux. In such a cases, be sure to check the devices' reliability.

(4) Noise resistance

It is believed that the use of optical transfer devices improve noise resistance. In theory, optical fiber is not affected by noise at all. However, receiving modules which handle signals whose level is extremely small, are susceptible to noise.

TOSLINK improve noise resistance to use a conductive case. However, the current signal output by the optical receiving modules' photodiode is extremely small. Thus, in some environments, shielding the case may not achieve sufficient noise resistance.

First systems which incorporate TOSLINK, Toshiba recommend testing using the actual device to check its noise resistance.

Use a simple noise filter on TOSLINK fiber optic transceiving module's power line. If the ripple in the power supply used is significant, reinforce the filter.

The optical module is to be used in an area which is susceptible to radiated noise, increase the shielding by covering the optical module and the power line filter with a metallic cover.

(5) Vibration and shock

This module is plastic sealed and has its wire fixed by resin. This structure is relatively resistant to vibration and shock. In actual equipment, there are sometime cases in which vibration, shock, or stress is applied to soldered parts or connected parts, resulting in lines cut. A care must be taken in the design of equipment which will be subject to high levels of vibration.

(6) Fixing fiber optical transceiving module

Solder the fixed pin (pins 9 and 10) of fiber optic transceiving module TODX298 to the printed circuit board to fix the module to the board.

(7) Shielding and wiring pattern of fiber optic transceiving modules

To shield, connect the fixed pins (pins 9 and 10) of fiber optic transceiving module TODX298 to the GND.

Where the fiber optic transceiving module uses conductive resin, be careful that the case does not touch wiring (including land).

To improve noise resistance, shield the optical module and the power line filter using a metallic cover.

- (8) Solvent
When using solvent for flux removal, do not use a high acid or high alkali solvent. Be careful not to pour solvent in to the optical connector ports. If solvent is inadvertently poured in to them, clean it off using cotton tips.
- (9) Protective cap
When the TODX298 is not in use, attach the protective cap.
- (10) Supply voltage
Use the supply voltage within the recommended operating condition ($V_{CC} = 5 \pm 0.25 \text{ V}$). Make sure that supply voltage does not exceed the maximum rating value of 7 V, even for an instant.
- (11) Input voltage
If a voltage exceeding the maximum rating value ($V_{CC} + 0.5 \text{ V}$) is applied to the transmitter input, the internal IC may suffer damage. If there is a possibility that excessive voltage due to surges may be added to the input terminal, insert a protective circuit.
- (12) Output
If the receiver output is at low and is connected to the power supply, or if the output is high and is connected to GND, the internal IC may be destroyed.
- (13) Soldering condition
Solder at 260°C or less for no more than three seconds.
- (14) Precautions when disposing of devices and packing materials.
When disposing devices and packing materials, follow the procedures stipulated by local regulations in order to protect the environment against contamination.
Compound semiconductors such as GaAs are used as LED materials in this module. When devices are disposed of, worker safety and protection of the environment must be taken into account.
- (15) Precautions during use
Toshiba is continually working to improve the quality and the reliability of their products. Nevertheless, semiconductor devices in general can malfunction or fail due to their inherent electrical sensitivity and their vulnerability to physical stress. It is the responsibility of the buyer, when utilizing Toshiba products, to observe standards of safety, and to avoid situations in which the malfunction or failure of a Toshiba product could cause loss of human life, bodily injury or damage to property.
When developing equipment, please ensure that Toshiba products are used within the specified operating ranges set forth in the most recent product specifications. Also, please keep in mind the precautions and conditions set forth in the Toshiba Semiconductor Reliability Handbook.

RESTRICTIONS ON PRODUCT USE

000707EAC

- TOSHIBA is continually working to improve the quality and reliability of its products. Nevertheless, semiconductor devices in general can malfunction or fail due to their inherent electrical sensitivity and vulnerability to physical stress. It is the responsibility of the buyer, when utilizing TOSHIBA products, to comply with the standards of safety in making a safe design for the entire system, and to avoid situations in which a malfunction or failure of such TOSHIBA products could cause loss of human life, bodily injury or damage to property.
In developing your designs, please ensure that TOSHIBA products are used within specified operating ranges as set forth in the most recent TOSHIBA products specifications. Also, please keep in mind the precautions and conditions set forth in the "Handling Guide for Semiconductor Devices," or "TOSHIBA Semiconductor Reliability Handbook" etc..
- The TOSHIBA products listed in this document are intended for usage in general electronics applications (computer, personal equipment, office equipment, measuring equipment, industrial robotics, domestic appliances, etc.). These TOSHIBA products are neither intended nor warranted for usage in equipment that requires extraordinarily high quality and/or reliability or a malfunction or failure of which may cause loss of human life or bodily injury ("Unintended Usage"). Unintended Usage include atomic energy control instruments, airplane or spaceship instruments, transportation instruments, traffic signal instruments, combustion control instruments, medical instruments, all types of safety devices, etc.. Unintended Usage of TOSHIBA products listed in this document shall be made at the customer's own risk.
- Gallium arsenide (GaAs) is a substance used in the products described in this document. GaAs dust and fumes are toxic. Do not break, cut or pulverize the product, or use chemicals to dissolve them. When disposing of the products, follow the appropriate regulations. Do not dispose of the products with other industrial waste or with domestic garbage.
- The information contained herein is presented only as a guide for the applications of our products. No responsibility is assumed by TOSHIBA CORPORATION for any infringements of intellectual property or other rights of the third parties which may result from its use. No license is granted by implication or otherwise under any intellectual property or other rights of TOSHIBA CORPORATION or others.
- The information contained herein is subject to change without notice.