

# 2SC5130

Silicon NPN Triple Diffused Planar Transistor (High Voltage and High Speed Switching Transistor) Application : Switching Regulator and General Purpose

### Absolute maximum ratings (Ta=25°C)

Symbol	Ratings	Unit
V <sub>CB0</sub>	600	V
V <sub>CEO</sub>	400	V
V <sub>EBO</sub>	10	V
I <sub>C</sub>	5(Pulse10)	A
I <sub>B</sub>	2	A
P <sub>C</sub>	30(T <sub>C</sub> =25°C)	W
T <sub>J</sub>	150	°C
T <sub>stg</sub>	-55 to +150	°C

### Electrical Characteristics (Ta=25°C)

Symbol	Conditions	Ratings	Unit
I <sub>CB0</sub>	V <sub>CB</sub> =500V	100max	μA
I <sub>EBO</sub>	V <sub>EB</sub> =10V	10max	μA
V(BR) <sub>CEO</sub>	I <sub>C</sub> =25mA	400min	V
h <sub>FE</sub>	V <sub>CE</sub> =4V, I <sub>C</sub> =1.5A	10 to 30	
V <sub>CE(sat)</sub>	I <sub>C</sub> =1.5A, I <sub>B</sub> =0.3A	0.5max	V
V <sub>BE(sat)</sub>	I <sub>C</sub> =1.5A, I <sub>B</sub> =0.3A	1.3max	V
f <sub>r</sub>	V <sub>CE</sub> =12V, I <sub>E</sub> =-0.3A	20typ	MHz
COB	V <sub>CB</sub> =10V, f=1MHz	30typ	pF

### External Dimensions FM20(TO220F)

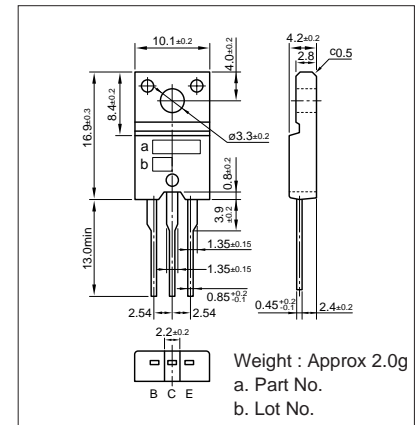

### Typical Switching Characteristics (Common Emitter)

V <sub>CC</sub> (V)	R <sub>L</sub> (Ω)	I <sub>C</sub> (A)	V <sub>BB1</sub> (V)	V <sub>BB2</sub> (V)	I <sub>B1</sub> (A)	I <sub>B2</sub> (A)	t <sub>on</sub> (μs)	t <sub>stg</sub> (μs)	t <sub>f</sub> (μs)
200	133	1.5	10	-5	0.15	-0.3	1max	2max	0.3max

I<sub>C</sub>-V<sub>CE</sub> Characteristics (Typical)

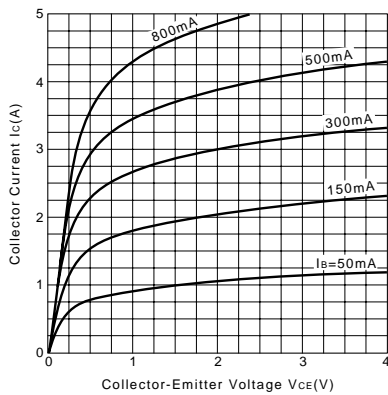

V<sub>CE(sat)</sub>-I<sub>C</sub> Characteristics (Typical)

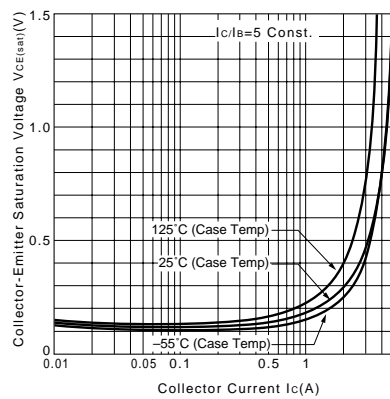

I<sub>C</sub>-V<sub>BE</sub> Temperature Characteristics (Typical)

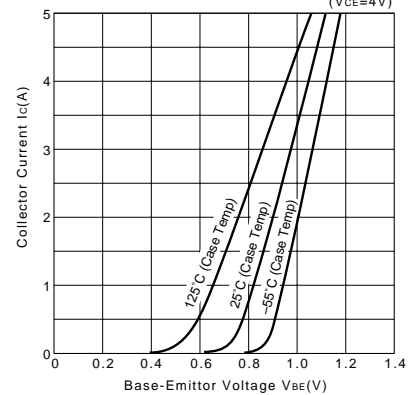

h<sub>FE</sub>-I<sub>C</sub> Characteristics (Typical)

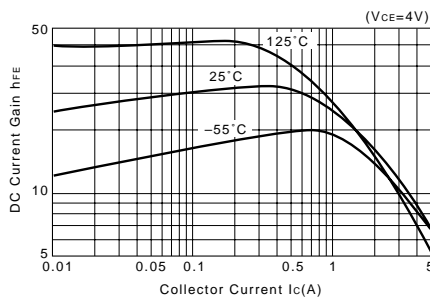

t<sub>on</sub>\*t<sub>stg</sub>\*t<sub>f</sub>-I<sub>C</sub> Characteristics (Typical)

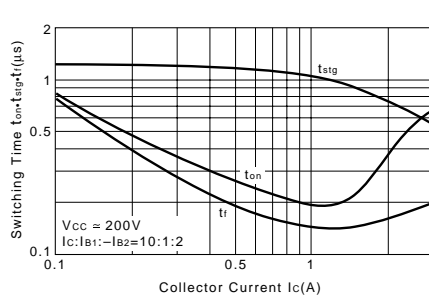

θ<sub>j-a</sub>-t Characteristics

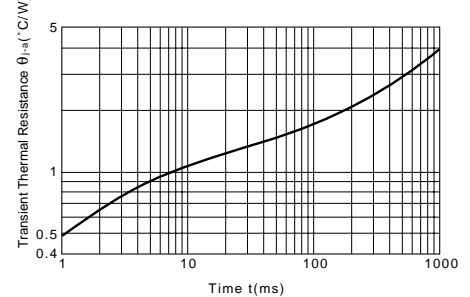

Safe Operating Area (Single Pulse)

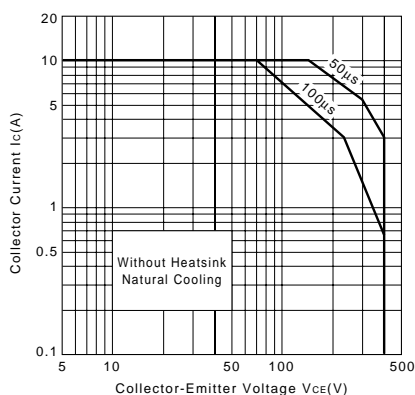

Reverse Bias Safe Operating Area

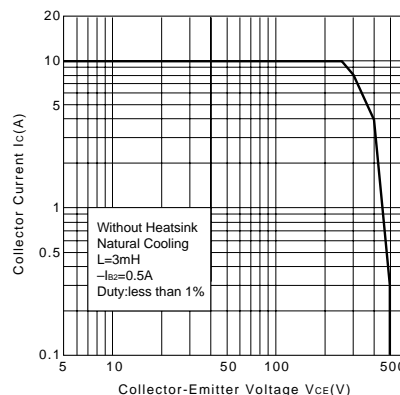

P<sub>C</sub>-T<sub>a</sub> Derating

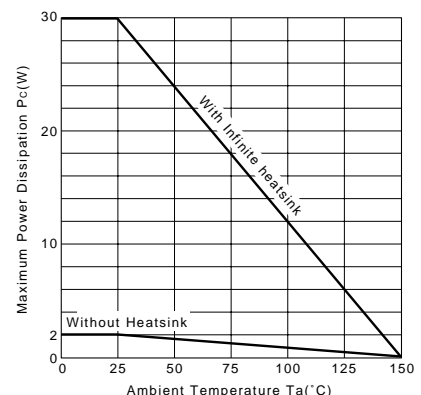

This datasheet has been download from:

[www.datasheetcatalog.com](http://www.datasheetcatalog.com)

Datasheets for electronics components.