

CHIPLED

LY R976, LO R976, LS R976

Besondere Merkmale

- Gehäusebauform: 0805
- Industriestandard bzgl. Lötpadraster
- geringe Bauteilhöhe
- für IR-Lötung geeignet
- für Hinterleuchtungen und als opt. Indikator einsetzbar
- gegurtet (8-mm-Filmgurt)

Features

- 0805 package
- Industry standard footprint
- low profile
- suitable for IR reflow soldering process
- for use as optical indicator and backlighting
- available taped on reel (8 mm tape)

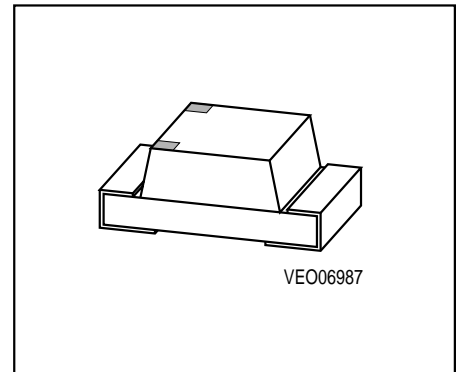

Typ	Emissions- farbe	Farbe der Lichtaustritts- fläche	Lichtstärke	Lichtstrom	Bestellnummer
Type	Color of Emission	Color of the Light Emitting Area	Luminous Intensity $I_F = 20 \text{ mA}$ $I_V \text{ (mcd)}$	Luminous Flux $I_F = 20 \text{ mA}$ $\Phi_V \text{ (mlm)}$	Ordering Code
LY R976-MO	yellow	colorless clear	≥ 16 (30 typ.)	250 (typ.)	Q62702-P5105
LO R976-NO	orange		≥ 25 (55 typ.)	450 (typ.)	Q62702-P5101
LS R976-NO	super-red		≥ 25 (55 typ.)	450 (typ.)	Q62702-P5103

Grenzwerte
Maximum Ratings

Bezeichnung Parameter	Symbol Symbol	Werte Values	Einheit Unit
Betriebstemperatur Operating temperature range	T_{op}	- 30 ... + 85	°C
Lagertemperatur Storage temperature range	T_{stg}	- 40 ... + 85	°C
Sperrschichttemperatur Junction temperature	T_j	+ 95	°C
Durchlaßstrom Forward current	I_F	25	mA
Stoßstrom Surge current $t \leq 10 \mu s, D = 0.005$	I_{FM}	0.1	A
Sperrspannung Reverse voltage	V_R	3	V
Verlustleistung, $T_A = 25 \text{ °C}$ Power dissipation, $T_A = 25 \text{ °C}$	P_{tot}	70	mW
Wärmewiderstand Sperrschicht / Umgebung Thermal resistance Junction / air	$R_{th JA}$	700	K/W

Kennwerte ($T_A = 25 \text{ }^\circ\text{C}$)

Characteristics

Bezeichnung Parameter	Symbol Symbol	Werte Values			Einheit Unit
		LY	LO	LS	
Wellenlänge des emittierten Lichtes Wavelength at peak emission $I_F = 20 \text{ mA}$ (typ.)	λ_{peak}	591	610	645	nm
Dominantwellenlänge Dominant wavelength $I_F = 20 \text{ mA}$ (typ.)	λ_{dom}	587	605	632	nm
Spektrale Bandbreite bei 50 % $I_{\text{rel max}}$ Spectral bandwidth at 50 % $I_{\text{rel max}}$ $I_F = 20 \text{ mA}$ (typ.)	$\Delta\lambda$	15	16	16	nm
Abstrahlwinkel bei 50 % I_v (Vollwinkel) Viewing angle at 50 % I_v	2ϕ	160	160	160	Grad deg.
Durchlaßspannung Forward voltage $I_F = 20 \text{ mA}$ (typ.) $I_F = 20 \text{ mA}$ (max.)	V_F V_F	2.0 2.6	2.0 2.6	2.0 2.6	V V
Sperrstrom Reverse current (typ.) $V_R = 3 \text{ V}$ (max.)	I_R I_R	0.01 10	0.01 10	0.01 10	μA μA
Temperaturkoeffizient von λ_{peak} Temperature coefficient of λ_{peak} $I_F = 20 \text{ mA}$ (typ.)	$TC_{\lambda_{\text{peak}}}$	0.13	0.13	0.14	nm/K
Temperaturkoeffizient von λ_{dom} Temperature coefficient of λ_{dom} $I_F = 20 \text{ mA}$ (typ.)	$TC_{\lambda_{\text{dom}}}$	0.10	0.07	0.01	nm/K
Temperaturkoeffizient von V_F Temperature coefficient of V_F $I_F = 20 \text{ mA}$ (typ.)	TC_{V_F}	-2.5	-1.7	-2.0	mV/K

Relative spektrale Emission $I_{rel} = f(\lambda)$, $T_A = 25\text{ °C}$, $I_F = 20\text{ mA}$

Relative spectral emission

$V(\lambda)$ = spektrale Augenempfindlichkeit

Standard eye response curve

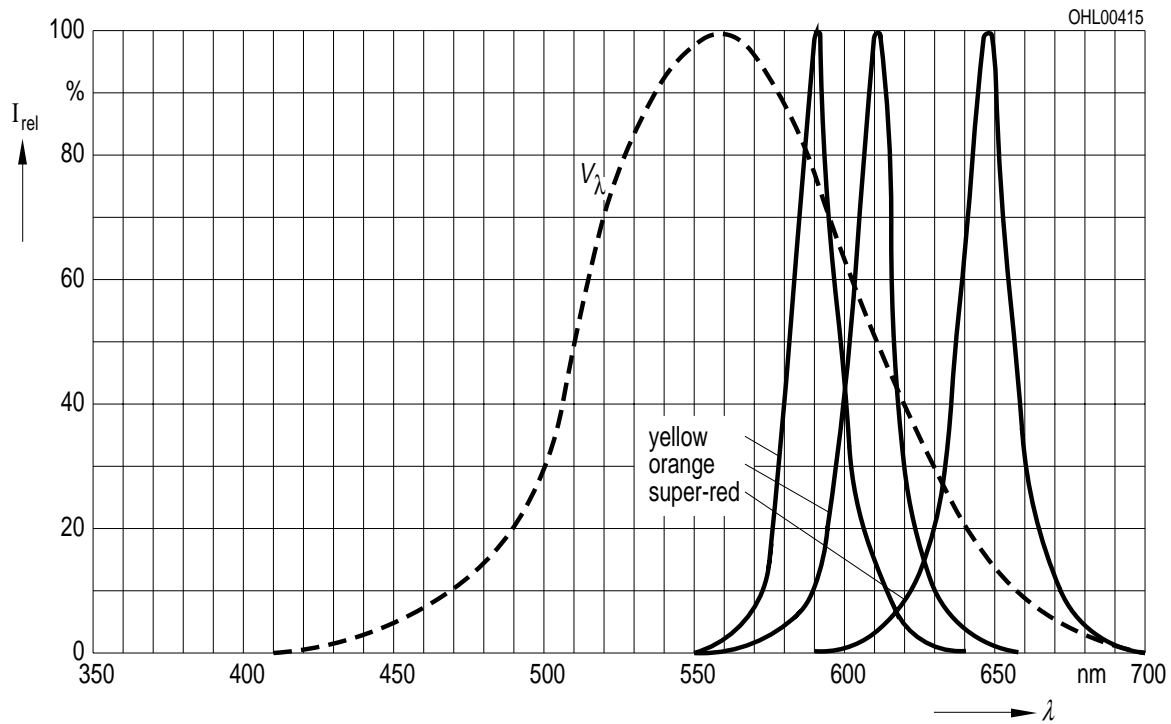

Abstrahlcharakteristik $I_{rel} = f(\varphi)$

Radiation characteristic

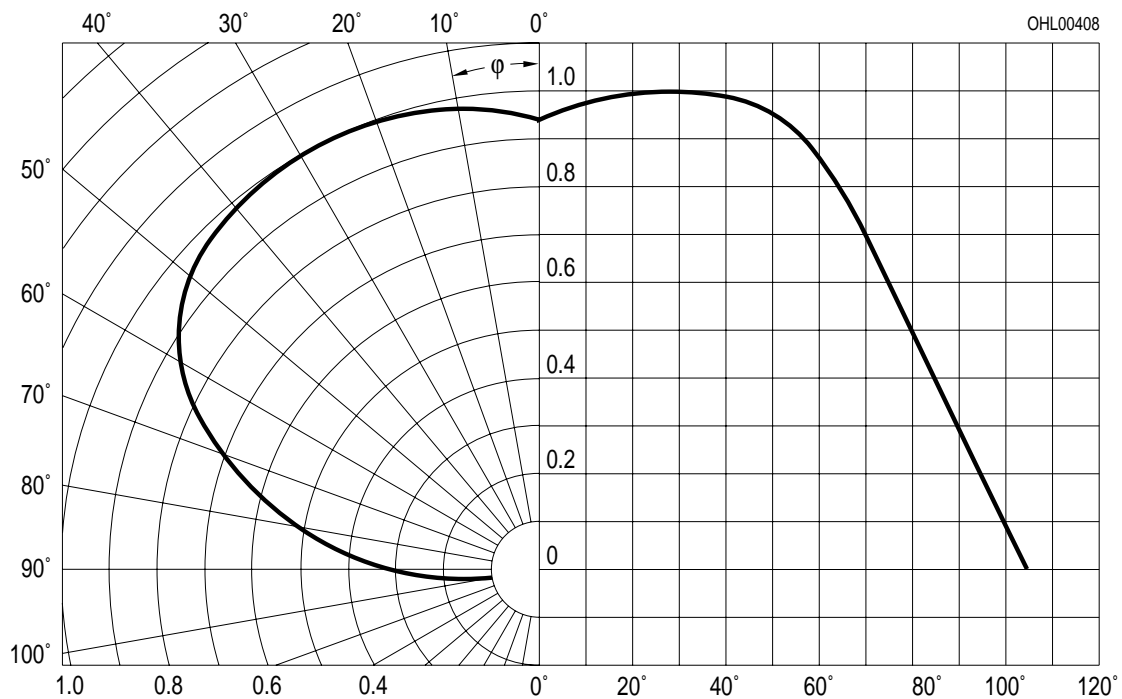

Durchlaßstrom $I_F = f(V_F)$

Forward current

$T_A = 25\text{ °C}$

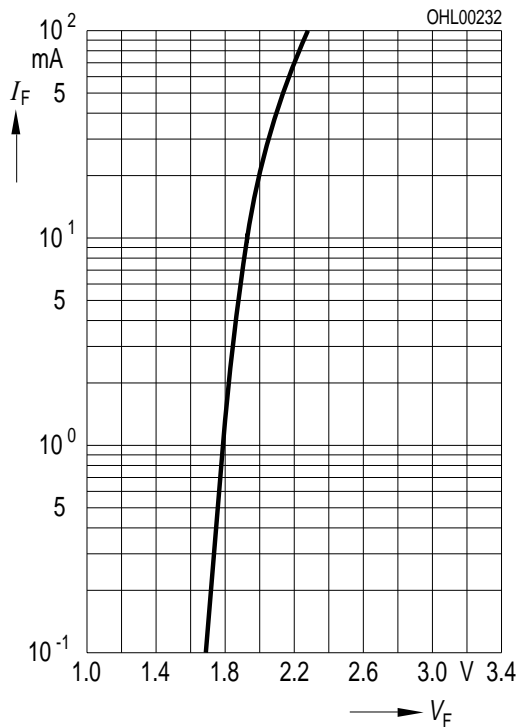

Relative Lichtstärke $I_V / I_{V(20\text{ mA})} = f(I_F)$

Relative luminous intensity

$T_A = 25\text{ °C}$

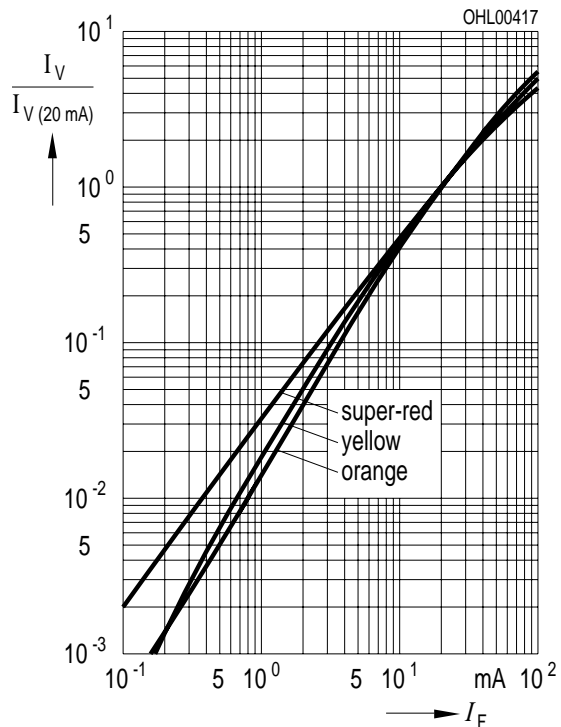

Maximal zulässiger Durchlaßstrom

Max. permissible forward current

$I_F = f(T_A)$

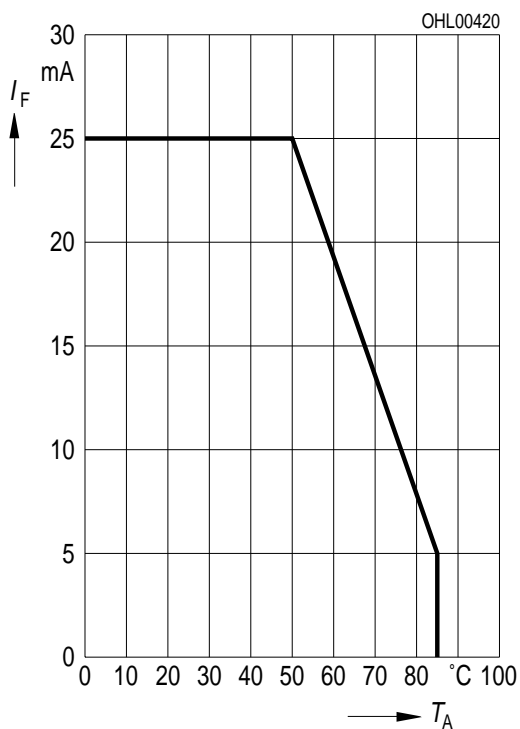

Relative Lichtstärke $I_V / I_{V(25\text{ °C})} = f(T_A)$

Relative luminous intensity

$I_F = 20\text{ mA}$

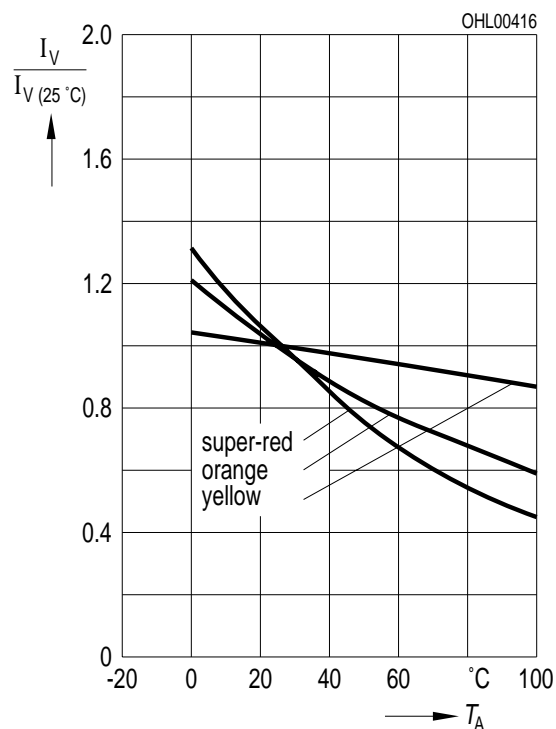

Maßzeichnung (Maße in mm, wenn nicht anders angegeben)
Package Outlines (Dimensions in mm, unless otherwise specified)

