

P-CHANNEL MOS FIELD EFFECT TRANSISTOR
FOR SWITCHING

DESCRIPTION

The 2SJ647 is a switching device which can be driven directly by a 2.5 V power source.

The 2SJ647 features a low on-state resistance and excellent switching characteristics, and is suitable for applications such as power switch of portable machine and so on.

FEATURES

- 2.5 V drive available
- Low on-state resistance
 $R_{DS(on)1} = 1.45 \Omega \text{ MAX. (} V_{GS} = -4.5 \text{ V, } I_D = -0.2 \text{ A)}$
 $R_{DS(on)2} = 1.55 \Omega \text{ MAX. (} V_{GS} = -4.0 \text{ V, } I_D = -0.2 \text{ A)}$
 $R_{DS(on)3} = 2.98 \Omega \text{ MAX. (} V_{GS} = -2.5 \text{ V, } I_D = -0.15 \text{ A)}$

PACKAGE DRAWING (Unit: mm)

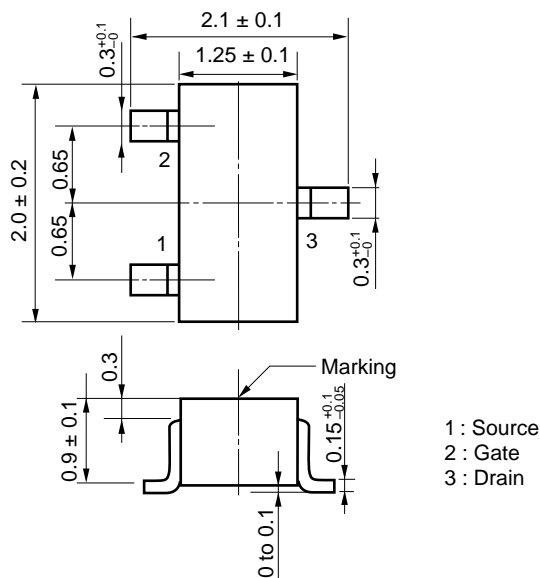

ORDERING INFORMATION

PART NUMBER	PACKAGE
2SJ647	SC-70 (SSP)

Remark Marking: H22

ABSOLUTE MAXIMUM RATINGS (T_A = 25°C)

Drain to Source Voltage (V _{GS} = 0 V)	V _{DSS}	-20	V
Gate to Source Voltage (V _{DS} = 0 V)	V _{GSS}	±12	V
Drain Current (DC) (T _A = 25°C)	I _{D(DC)}	±0.4	A
Drain Current (pulse) ^{Note1}	I _{D(pulse)}	±1.6	A
Total Power Dissipation ^{Note2}	P _T	0.2	W
Channel Temperature	T _{ch}	150	°C
Storage Temperature	T _{stg}	-55 to +150	°C

- Notes 1. PW ≤ 10 μs, Duty Cycle ≤ 1%
 2. Mounted on FR-4 board of 2500 mm² x 1.1 mm.

Remark The diode connected between the gate and source of the transistor serves as a protector against ESD. When this device actually used, an additional protection circuit is externally required if a voltage exceeding the rated voltage may be applied to this device.

Caution This product is electrostatic-sensitive device due to low ESD capability and should be handled with caution for electrostatic discharge.
 V_{ESD} ±100 V TYP. at C = 200 pF, R = 0, Single Pulse.

EQUIVALENT CIRCUIT

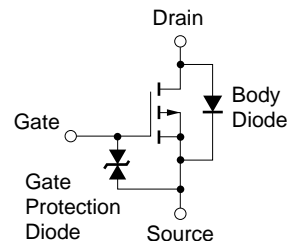

The information in this document is subject to change without notice. Before using this document, please confirm that this is the latest version.
 Not all products and/or types are available in every country. Please check with an NEC Electronics sales representative for availability and additional information.

ELECTRICAL CHARACTERISTICS (T_A = 25°C)

CHARACTERISTICS	SYMBOL	TEST CONDITIONS	MIN.	TYP.	MAX.	UNIT
Zero Gate Voltage Drain Current	I _{DSS}	V _{DS} = -20 V, V _{GS} = 0 V			-1.0	μA
Gate Leakage Current	I _{GSS}	V _{GS} = ±12 V, V _{DS} = 0 V			±10	μA
Gate Cut-off Voltage	V _{GS(off)}	V _{DS} = -10 V, I _D = -1.0 mA	-0.8	-1.3	-1.8	V
Forward Transfer Admittance	y _{fs}	V _{DS} = -10 V, I _D = -0.2 A	0.2	0.6		S
Drain to Source On-state Resistance	R _{DS(on)1}	V _{GS} = -4.5 V, I _D = -0.2 A		1.17	1.45	Ω
	R _{DS(on)2}	V _{GS} = -4.0 V, I _D = -0.2 A		1.25	1.55	Ω
	R _{DS(on)3}	V _{GS} = -2.5 V, I _D = -0.15 A		2.25	2.98	Ω
Input Capacitance	C _{iss}	V _{DS} = -10 V		29		pF
Output Capacitance	C _{oss}	V _{GS} = 0 V		15		pF
Reverse Transfer Capacitance	C _{rss}	f = 1.0 MHz		3		pF
Turn-on Delay Time	t _{d(on)}	V _{DD} = -10 V, I _D = -0.2 A		23		ns
Rise Time	t _r	V _{GS} = -4.0 V		39		ns
Turn-off Delay Time	t _{d(off)}	R _G = 10 Ω		50		ns
Fall Time	t _f			33		ns
Body Diode Forward Voltage	V _{F(S-D)}	I _F = 0.4 A, V _{GS} = 0 V		0.93		V

TEST CIRCUIT SWITCHING TIME

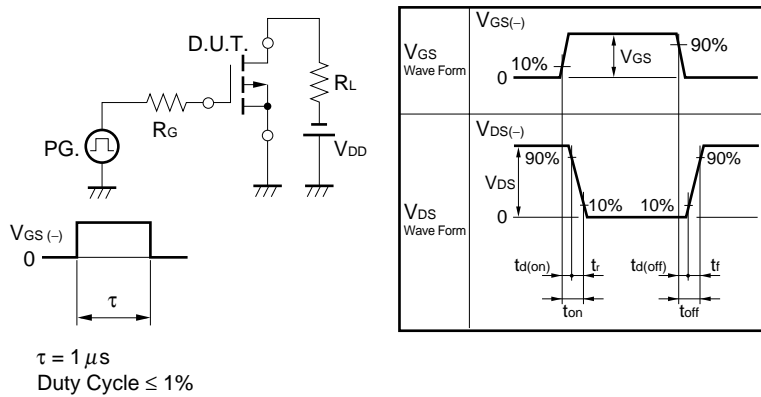

TYPICAL CHARACTERISTICS (T_A = 25°C)

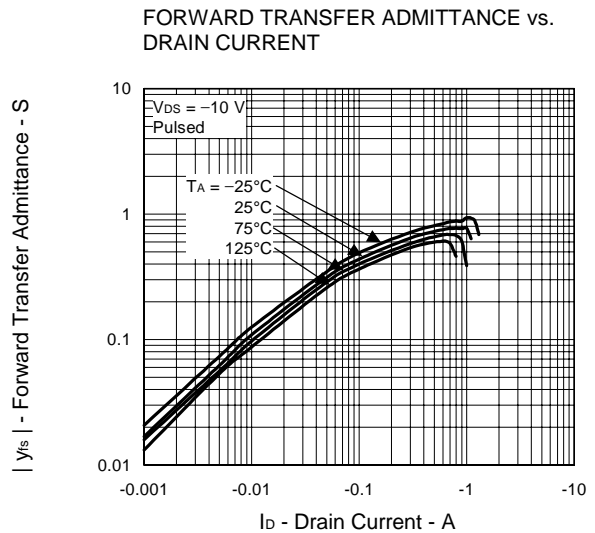
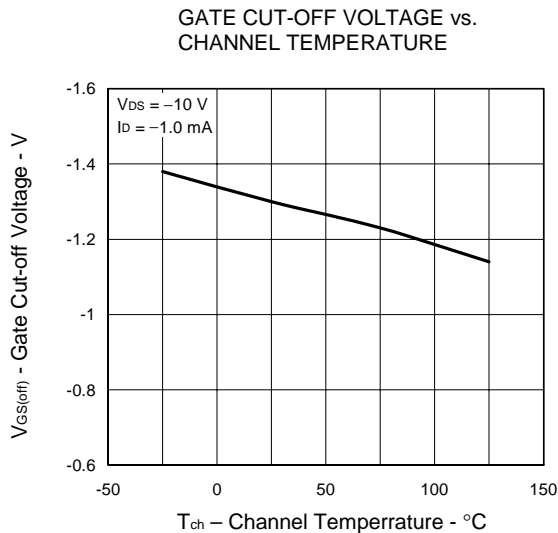
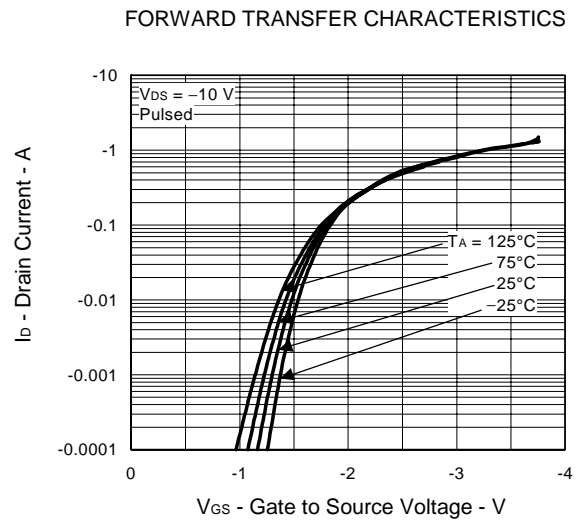
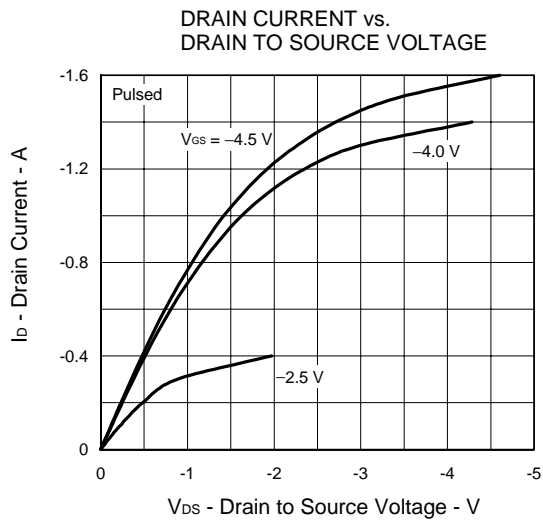
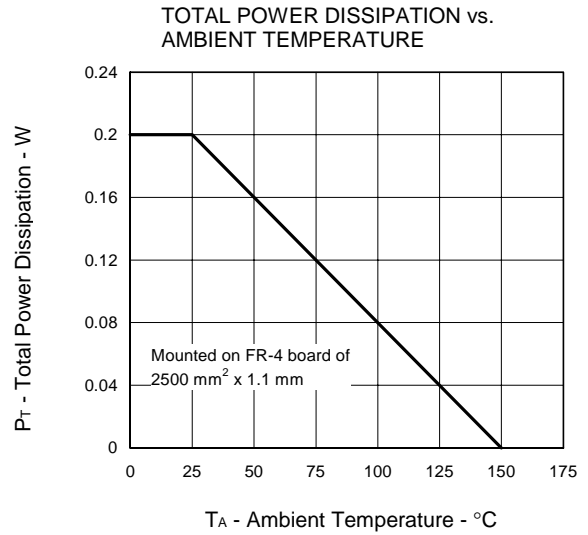
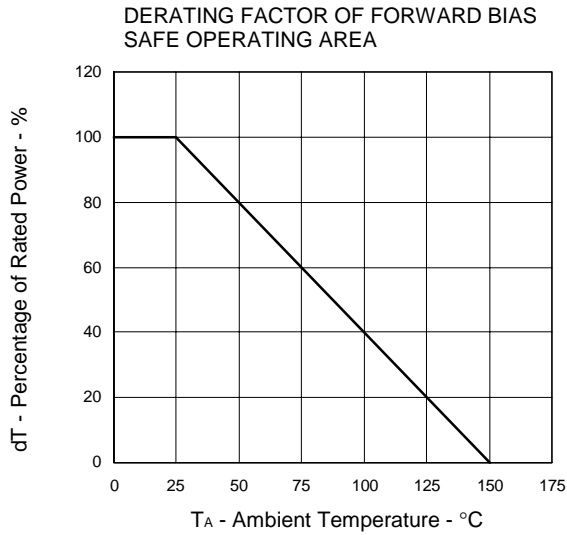

DRAIN TO SOURCE ON-STATE RESISTANCE vs. CHANNEL TEMPERATURE

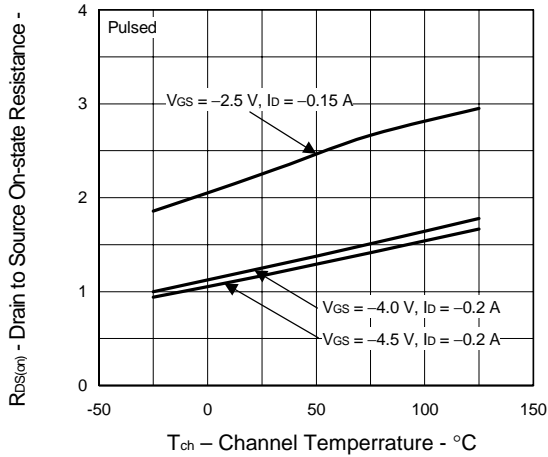

DRAIN TO SOURCE ON-STATE RESISTANCE vs. GATE TO SOURCE VOLTAGE

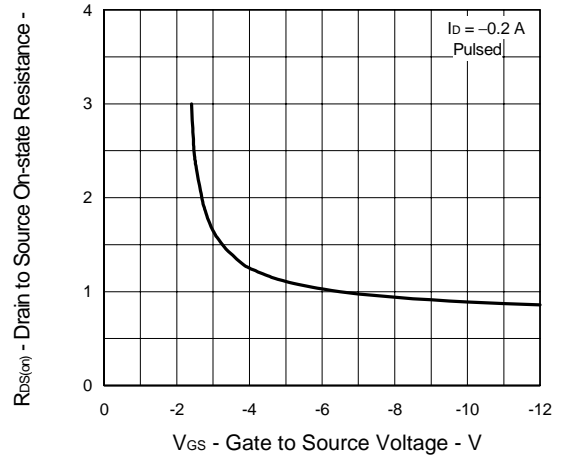

DRAIN TO SOURCE ON-STATE RESISTANCE vs. DRAIN CURRENT

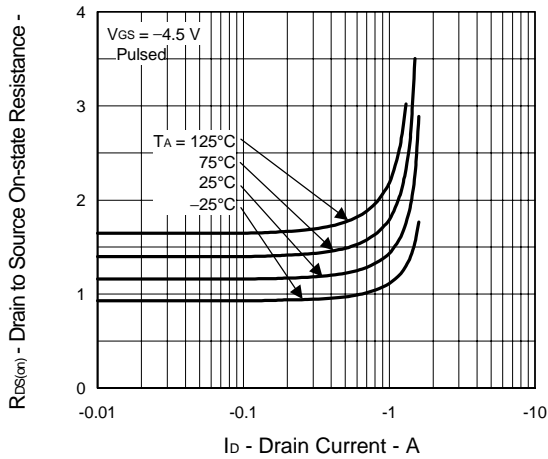

DRAIN TO SOURCE ON-STATE RESISTANCE vs. DRAIN CURRENT

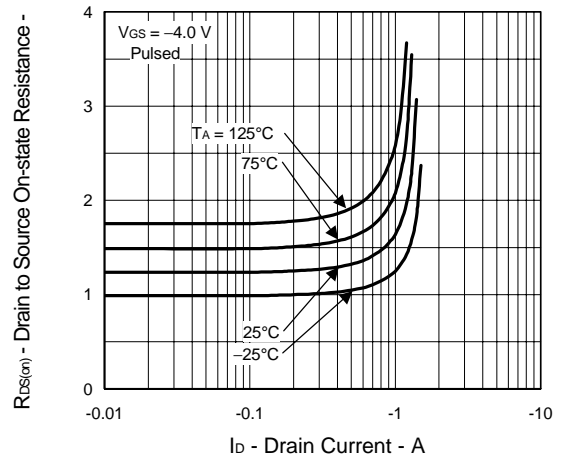

DRAIN TO SOURCE ON-STATE RESISTANCE vs. DRAIN CURRENT

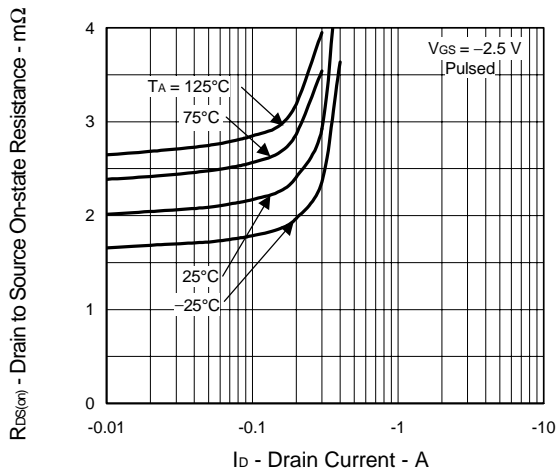

CAPACITANCE vs. DRAIN TO SOURCE VOLTAGE

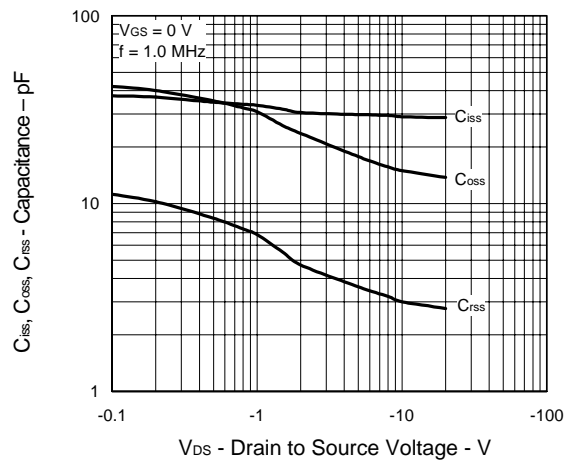

SWITCHING CHARACTERISTICS

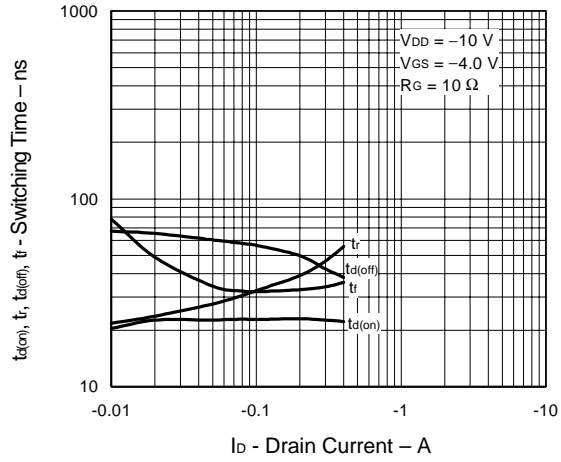

SOURCE TO DRAIN DIODE FORWARD VOLTAGE

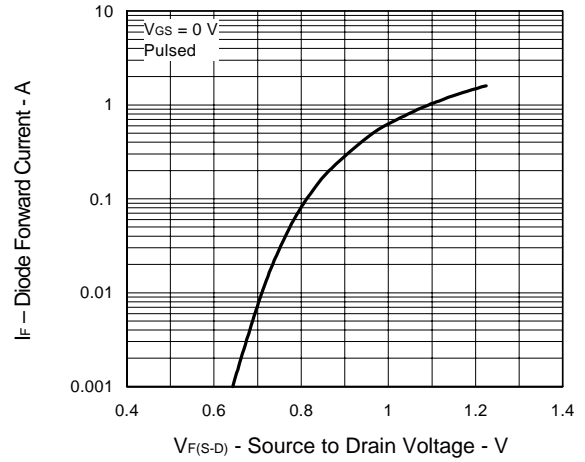

- **The information in this document is current as of January, 2003. The information is subject to change without notice. For actual design-in, refer to the latest publications of NEC Electronics data sheets or data books, etc., for the most up-to-date specifications of NEC Electronics products. Not all products and/or types are available in every country. Please check with an NEC Electronics sales representative for availability and additional information.**
- No part of this document may be copied or reproduced in any form or by any means without the prior written consent of NEC Electronics. NEC Electronics assumes no responsibility for any errors that may appear in this document.
- NEC Electronics does not assume any liability for infringement of patents, copyrights or other intellectual property rights of third parties by or arising from the use of NEC Electronics products listed in this document or any other liability arising from the use of such products. No license, express, implied or otherwise, is granted under any patents, copyrights or other intellectual property rights of NEC Electronics or others.
- Descriptions of circuits, software and other related information in this document are provided for illustrative purposes in semiconductor product operation and application examples. The incorporation of these circuits, software and information in the design of a customer's equipment shall be done under the full responsibility of the customer. NEC Electronics assumes no responsibility for any losses incurred by customers or third parties arising from the use of these circuits, software and information.
- While NEC Electronics endeavors to enhance the quality, reliability and safety of NEC Electronics products, customers agree and acknowledge that the possibility of defects thereof cannot be eliminated entirely. To minimize risks of damage to property or injury (including death) to persons arising from defects in NEC Electronics products, customers must incorporate sufficient safety measures in their design, such as redundancy, fire-containment and anti-failure features.
- NEC Electronics products are classified into the following three quality grades: "Standard", "Special" and "Specific".

The "Specific" quality grade applies only to NEC Electronics products developed based on a customer-designated "quality assurance program" for a specific application. The recommended applications of an NEC Electronics product depend on its quality grade, as indicated below. Customers must check the quality grade of each NEC Electronics product before using it in a particular application.

"Standard": Computers, office equipment, communications equipment, test and measurement equipment, audio and visual equipment, home electronic appliances, machine tools, personal electronic equipment and industrial robots.

"Special": Transportation equipment (automobiles, trains, ships, etc.), traffic control systems, anti-disaster systems, anti-crime systems, safety equipment and medical equipment (not specifically designed for life support).

"Specific": Aircraft, aerospace equipment, submersible repeaters, nuclear reactor control systems, life support systems and medical equipment for life support, etc.

The quality grade of NEC Electronics products is "Standard" unless otherwise expressly specified in NEC Electronics data sheets or data books, etc. If customers wish to use NEC Electronics products in applications not intended by NEC Electronics, they must contact an NEC Electronics sales representative in advance to determine NEC Electronics' willingness to support a given application.

(Note)

- (1) "NEC Electronics" as used in this statement means NEC Electronics Corporation and also includes its majority-owned subsidiaries.
- (2) "NEC Electronics products" means any product developed or manufactured by or for NEC Electronics (as defined above).

This datasheet has been download from:

www.datasheetcatalog.com

Datasheets for electronics components.