

Gunze Electronics USA Corporation

A Guide
to

CRS1

An Analog Touch Panel Controller Chip
Through Serial(CRS1-656),PS/2(CRS1-685)

First Print: JUN. 21, 1999
Rev4 AUG.15, 2000
Gunze Electronics USA Corporation
2113 Wells Branch Parkway
Austin, TX. 78728-6970
Telephone: (512) 252-1299
Fax: (512) 251-5687

This Guide contains the company's copyright and knowledge. You are advised not to use this Guide for applications other than this product intent. Copies and disclosures to third parties of this guide are strictly forbidden without written consent of Gunze Electronics USA Corporation.

**Some alteration of the guide due to improvements of products may be made without prior notice.
For questions regarding this product, please contact Gunze Electronics USA co..**

Table of Contents

1. General
2. Features
 - (1) Power Supply
 - (2) External Conditions Frequency
 - (3) Electric Resolution
 - (4) Communication
 - (5) Output Rate
 - (6) Output Mode
 - (7) Adaptable Touch Panel
3. Pin Configuration
 - (1) Terminal Arrangement Diagram
 - (2) Function of Terminals
4. Connection for 12bit A/D Converter
5. Absolute Maximum Rating
6. External Circuits
7. Settings
8. Continuous Mode
9. Serial Communication (CRS1-656)
 - (1) Communication Setting
 - (2) Data Format
 - (3) Response Speed
 - (4) List of Commands
10. PS/2 Communication (CRS1-685)
 - (1) Communication Setting
 - (2) Data Format
11. Other Functions
 - (1) Calibration
 - (2) Stop Mode
 - (3) Mouse Emulation
12. Warranty
 - (1) Warranty Period
 - (2) Warranty Clause

Appendixes

- * Sample Schematic for serial communication (CRS1-656)
 - * Sample Schematic for PS/2 communication (CRS1-685)
 - * Package Outline
 - * Storage and Soldering
-

1. General

The CRS1 is an interface controller chip which senses pressed positions of a transparent analog resistive touch panel and can eliminate unstable data (voltage value) generated by softly pressing it or some external noises coming into the circuitry. By the internal filtering process, all of the pressed positions can be sensed with a high degree of accuracy and these data are sent to your host system with serial communication (CRS1-656) or PS/2 communication (CRS1-685).

2. Features

(1) Power Supply

2.7 to 5.5 Volts

3.3 to 5.5 Volts (when using a 12bit external A/D converter)

(2) External Clock Frequency

4 MHz

(3) Electric Resolution

10 bit (1024 x 1024) or 12 bit (4096 x 4096 : with an external ADC)

Note: These values are electrical resolutions for the controller. The physical resolution of the touch panel key area is lower than that value and varies depending on each touch panel.

(4) Communication

Serial Communication (CRS1-656) or PS/2 Communication (CRS1-685)

(5) Output Rate

5-1 Serial Communication (CRS1-656)

A. AHL Mode (Gunze original Mode)

87cps (Coordinate Per Second).

B. ELO Emulation Mode **Limited command supported.** (*more likely to work with Monitor Mouse for Windows supplied by ELO Touch Systems through COM port.*)

Under the condition of Baud Rate=9600bps,Parity=No,Data Length=8, and Stop Bit=1

5-2 PS/2 Communication (CRS1-685)

about 100PPS (PPS: point per second)

(6) Output Mode

Continuously (When pressing the touch Panel, continuous data is being received.)

(7) Adaptable Touch panel

4 & 8 - wire resistive analog touch panel made by Gunze. 8 - wire is highly recommended. The CRS1 controller is recommended only for Gunze's touch panels.

3. Pin Configuration

(1) Terminal Arrangement Diagram

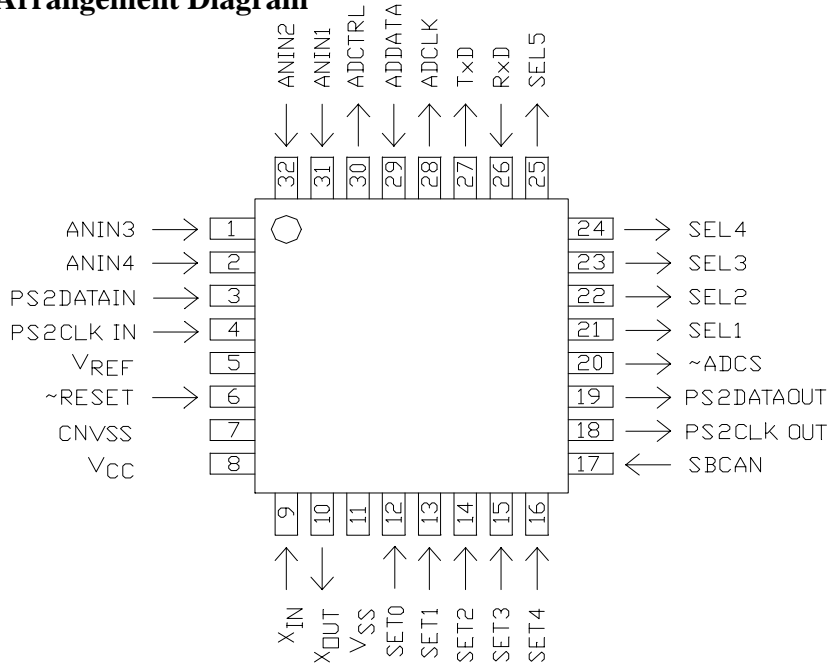

(2) Function of Terminals

FUNCTION	TERMINAL NAME	IN/OUT	PIN	FUNCTION	TERMINAL NAME	IN/OUT	PIN
POWER SUPPLY	V _{CC}		8	SET FOR COM / PS2	SET 0	IN	12
GND	V _{SS}		11	SET FOR COM. SPEED	SET 1	IN	13
REF. VOLTAGE FOR A/D CONVERTER	V _{REF}		5	SET FOR RESOLUTION	SET 2	IN	14
R4.7k PULL DOWN	CNVSS		7	SET FOR GUNZE / ELO	SET 3	IN	15
TOUCH PANEL CONTROL	SEL1	OUT	21	SET FOR COMMUNICATION FORMAT / STOP MODE	SET 4	IN	16
TOUCH PANEL CONTROL	SEL2	OUT	22	SERIAL DATA RECEIVE ⁴	RxD	IN	26
TOUCH PANEL CONTROL	SEL3	OUT	23	SERIAL DATA TRANSMISION	TxD	OUT	27
TOUCH PANEL CONTROL	SEL4	OUT	24	PS2 DATA IN ³	PS2DATAIN	IN	3
TOUCH PANEL CONTROL	SEL5	OUT	25	PS2 CLOCK IN ³	PS2CLKIN	IN	4
ANALOG INPUT ¹	ANIN1	IN	31	PS2 DATA OUT	PS2DATAOUT	OUT	19
ANALOG INPUT ¹	ANIN2	IN	32	PS2 CLOCK OUT	PS2CLKOUT	OUT	18
ANALOG INPUT ¹	ANIN3	IN	1	RESET	~RESET	IN	6
ANALOG INPUT ¹	ANIN4	IN	2	STOP MODE RELEASING	SBCAN	IN	17
EXTERNAL A/D CONTROL ²	~ADCS	OUT	20	CLOCK IN	X _N		9
EXTERNAL A/D CONTROL ²	ADCLK	OUT	28	CLOCK OUT	I _{OUT}		10
EXTERNAL A/D CONTROL ²	ADDATA	IN	29				
EXTERNAL A/D CONTROL ²	ADCTRL	OUT	30				

Footnote ¹: V_{SS} for 12bit resolution with external A/D converter.

Footnote ²: open for 10 bit resolution.

Footnote ³: open for the CRS1-656 in serial communication.

Footnote ⁴: V_{SS} for the CRS1-685 in PS/2 communication.

4. Connection for 12 bit A/D Converter

In the case of 12 bit resolution, need to wire lines with a A/D converter (Burr-Brown ADS7841) below.

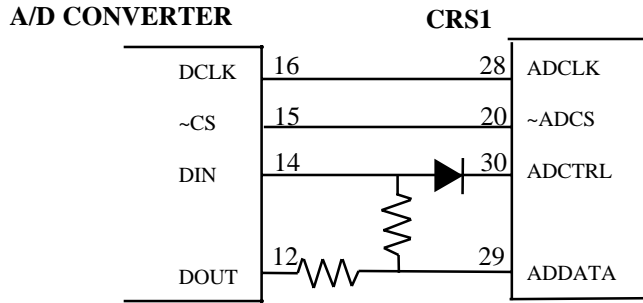

* When using the external A/D converter, ANIN 1,2,3,4 should be connected to V_{SS}.

5. Absolute Maximum Rating

ITEM	SYMBOL	CONDITION	RATING	UNIT
POWER VOLTAGE	V _{CC}		- 0.3 ~ 7.0	V
INPUT VOLTAGE	V _{IN}		V _{SS} - 0.3 ~ V _{CC} + 0.3	V
OUTPUT VOLTAGE	V _{OUT}		V _{SS} - 0.3 ~ V _{CC} + 0.3	V
POWER CONSUMPTION	P _D	T _a = 25°C	300	mW
POWER CURRENT	I _{CC}	4Mhz - 5v	3.5 - 6.5	mA
		STOP MODE	150	µA
OPERATING TEMPERATURE	T _{OPR}		- 20° ~ 85°	°C
STORAGE TEMPERATURE	T _{STG}		- 40° ~ 125°	°C

6. External Circuits

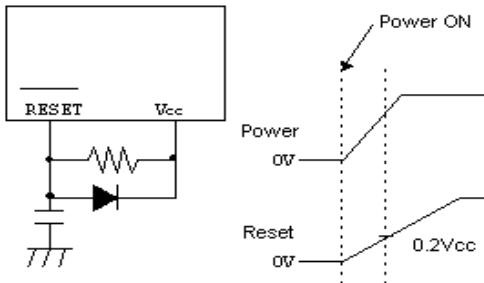

Fig-1 Reset Circuit

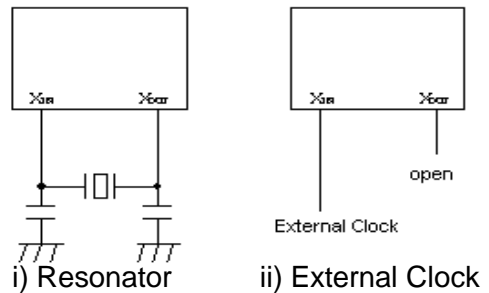

Fig-2 Clock Generating Circuit

7. Settings

SET 0	OPEN	SHORT
Mode	Serial (CRS1-656)	PS/2 (CRS1-685)

SET 1 (only for CRS1-656)	OPEN	SHORT
Speed	9600bps	19200bps

* ELO Driver requires 9600bps

SET 2	OPEN	SHORT
Resolution	10bit	12bit

SET 3 (only for CRS1-656)	OPEN	SHORT
Emulation Mode	Gunze	ELO Emulation

SET 4 (only for CRS1-656)	OPEN	SHORT
Gunze Mode	Stop Prohibited	Stop Permitted
ELO Emulation Mode	Binary	ASCII

* ELO Driver Requires Binary

8. Continuous Mode

When pressing the touch panel, the controller generates X-Y coordinates of the pressed position. If you maintain a continuous press, the controller keeps generating a string of data continuously. When releasing the press, a single data is generated. See below.

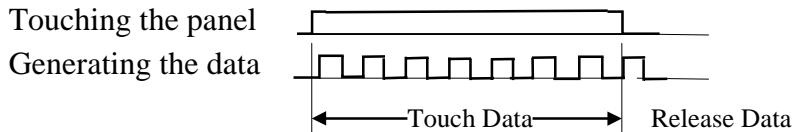

9. Serial Communication (CRS1-656)

(1) Communication Setting

- Baud Rate: 9600, 19200 bps (ELO Mode: 9600 bps)
- Data Bits : 8 bit
- Parity : unidentified
- Stop Bit : 1 bit

(2) Data Format

A. AHL Mode (Gunze original Mode)

Header ("T" or "R")	X Data (4 bytes)	Comma ","	Y Data (4 bytes)	CR (0DH)
------------------------	---------------------	--------------	---------------------	-------------

11 bytes/data are sent by 8 bits ASCII Format.

* An example in Continuous Mode

T0273,0581 ← Press

T0273,0582

T0272,0581

*

* Continuing to press

*

T0273,0582

R0273,0581 ← Release

- T as a header for pressing the touch panel, and R as a header for releasing it
- Position values of both X and Y are from 0 to 1023 in decimal
- The origin of X and Y axes is at the bottom left corner with proper line connections.

Note: By our experiment, the active position value is approximately from 20 to 1000 in usual.

B. ELO Emulation Mode

- Binary Format

Byte

1	Lead-In-Byte (55h)	
2	Touch Data Flag (54h)	
3	Touch Status	*Touch Status:FirstTouch 01h
4	X Lower Data (8 bit)	MiddleTouch 02h
5	X Upper Data (4 bit)	Release 04h
6	Y Lower Data (8 bit)	
7	Y Upper Data (4 bit)	
8	Z Lower Data (FFh)	
9	Z Upper Data (0h)	
10	SumCheck	*SumCheck means all additions from Byte 1 to Byte 9 and AAh.

*Z data is unavailable and fixed 255.

- ASCII Format

18 bytes/data are sent by 8 bits ASCII Format.

X Data (4 bytes)	Space	Y Data (4 bytes)	Space	Z Data (4 bytes)	Space	T / U	CR (0DH)
---------------------	-------	---------------------	-------	---------------------	-------	-------	-------------

(3) **Response Speed**

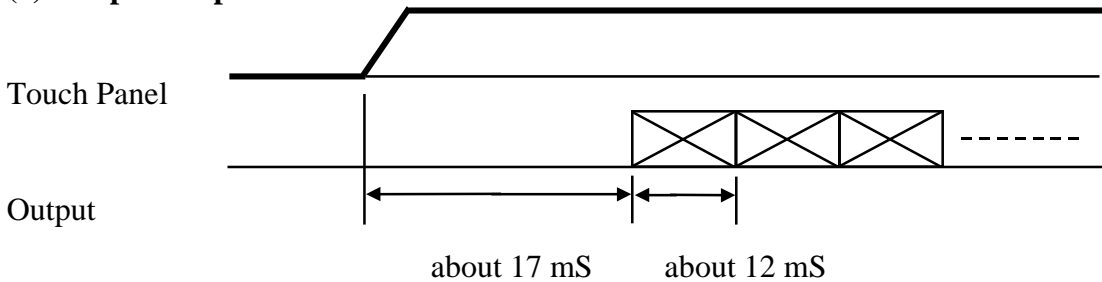

Note:

Data shown are based on the following settings:

- Baud Rate ----- 9600bps
- Parity ----- Unidentified
- Data Bits ----- 8 Bit
- Stop Bit ----- 1 Bit

(4) List of Commands

A. AHL Mode (Gunze original Mode)

Command	Actuation
RE	Reset Note: If the controller receives the command while sending data, the data may be affected.
DI	Diagnose the controller board. If normal, it returns Pass \$\$\$\$. * \$ stands for space.
SR	Stop sending transmission. Commands can be received while running. * While in data transmission, the transmission stops from the next data.
BR	Resume sending transmission
CTRL-S	(Same as "SR")
CTRL-Q	(Same as "SR")
VE	Return software version "V1.0\$\$" * \$ stands for space.
LF	Make data delimiter CR (0D H) and LF (0A H)
CR	Make data delimiter CR (0D H)
XL	Return X-Low reference data (calibration data) <e g.> "0012" *Reference Data are the data of an electrode voltage of the touch panel. The X-Low Reference Data are the data expressing an electrode voltage of the lower potential when the panel in X direction is electrically impressed.
XH	Return X-High reference data (calibration data) <e g.> "1002"
YL	Return Y-Low reference data (calibration data)
YH	Return Y-High reference data (calibration data)

Note: i. Send command by ASCII Format.

ii. When sending command, add CR (0DH) at the end.

iii. Either capital letters or small letters are good.

Command is executed immediately upon receiving it. Even if CRS1 is transmitting data, commands are received, and commands commanding response (e.g. "DI", "VE" &c) produce responding data followed by transmission of interrupted position data.

<Example> "DI" Command case

:

:

T0381, 0892

T0381, 0892

T0380, 0892

Pass

T0380, 0892

T0381, 0892

:

v. Responding data to the command are usually attached by CR (0DH) at the end

vi. If a command is not duly received or if the command is not contained in the commands list, such the command is ignored (without output).

vii. Take longer time than 15 mS between a command and the following command.

B. ELO Emulation Mode

Binary Mode

i. Acknowledge (a)

ii. Diagnostic (d)

iii. ID (i)

iv. Owner (o)

v. Quiet (q)

vi. Select Stop Mode (z) *Gunze original command

10. PS/2 Communication (CRS1-685)

Communication is established by the clock line and the data line in synchronous with clock signal.

Recommendation driver software is T5SETUP.EXE under Windows95.

Caution :Some computers can not be used through PS/2 port with the CRS1 controller, because its function is hardware oriented.

In the case of note book type computer, you should set up its internal pointing device prohibited because of conflict with the CRS1 and that device.

(1) Communication Setting

- Data length : 8bit
- Parity : Odd
- Stop bit : 1bit

(2) Data Format

	M SB				LSB			
1 st byte	1	X 9	X 8	X 7	X 6	X 5	X 4	X 3
2 nd byte	1	X 2	X 1	Y 0	Y 9	Y 8	Y 7	Y 6
3 rd byte	0	T/R	Y 5	Y 4	Y 3	Y 2	Y 1	Y 0

[T/R] 1: Touching 0: Releasing

[X9-X0]X position data X9: MSB X0: LSB

[Y9-Y0]Y position data Y9: MSB Y0: LSB

*X and Y data consist of 10bit.

*The range of X and Y data are from 0h to 3FFh(00 0000 0000 . —11 1111 1111 .).

11. Other Functions

(1) Calibration

I. Auto-Calibration

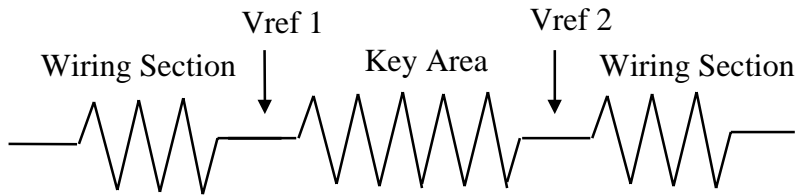

Illustration : Equivalent Circuit of Touch Panel

Generally, touch panels have an equivalent circuit as the illustration above shows. When a DC voltage is applied to both terminal ends of the touch panel, the total voltage drop across the circuit is equal to the sum of the voltage drops of a key area and both wiring sections. Each voltage drop will vary when any resistance varies. It means that a position shift on the monitor will occur even on the same point to be pressed if any resistance changes.

On the contrary, the combination of the controller and a 8-wire touch panel has an auto-calibration function which eliminates the resistance of both wiring sections by reading reference voltage, such as Vref 1, Vref 2. Those reference data are detected when powering on, sending reset command(only in serial communication), or returning from Stop Mode, and stored in the controller memory during powering on. After those processes, the controller generates data which are adjusted from 0 to 1023 over the key area. Therefore, you can get very stable data in various environmental conditions for a long period of time in use.

Difference between 4-wire touch panel and 8-wire touch panel

[4 wires Touch Panel]

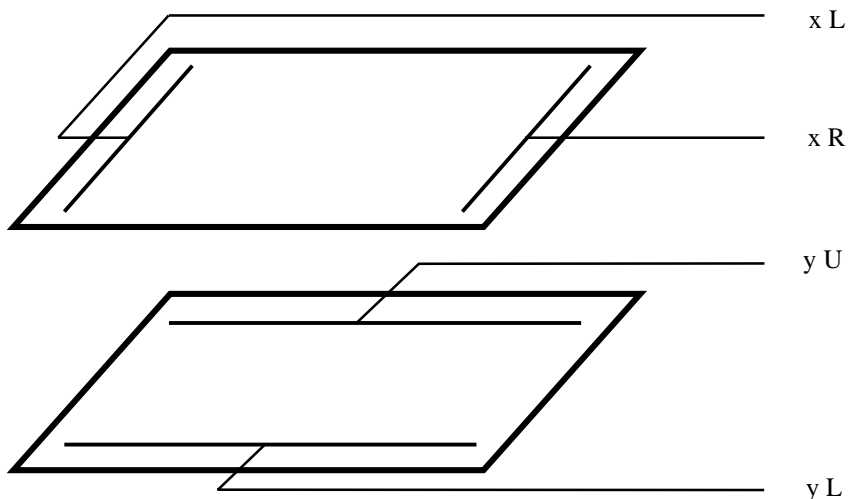

The controller outputs the digital position data converted from the analog voltage of the pressed position. For example, when the analog voltage of the pressed point is 2(V) for applying 5(V) to the terminals, “409” is the outputted data. $2(V) / 5(V) \times 1023 = 409$

[8 wires Touch Panel]

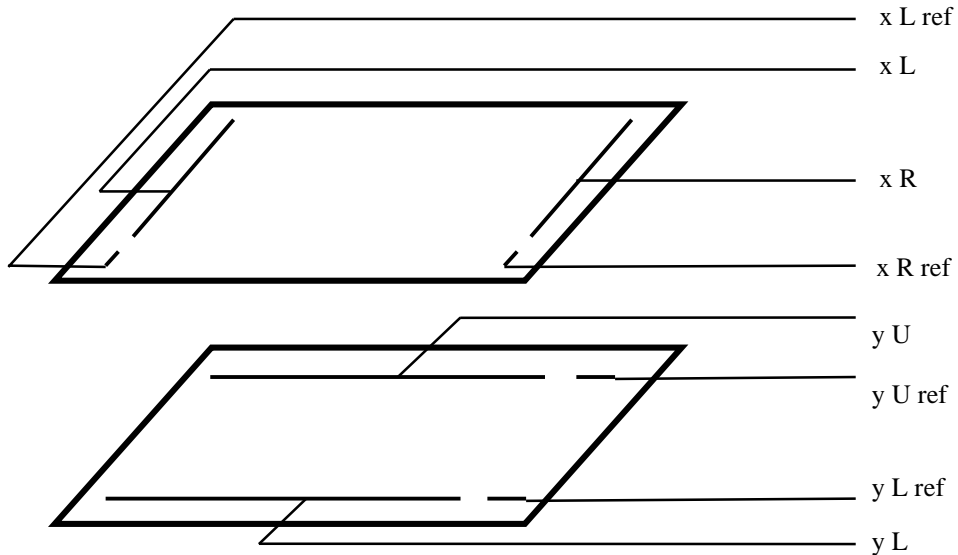

The controller reads reference voltages (xRref, xLref, yUref, yLref) and outputs a compensated pressed position data calculated on the basis with xRref=0, xLref=1023, yUref=0, yLref=1023. For example, when the analog voltage of the pressed point is 2(V) for applying 5(V) to the terminals and xRref=20, xLref=1000, “406” is the outputted data.
 $2(V) / 5(V) \times 1023 = 409$, $(409-20) \times (1023 / (1000-20)) = 406$

II. User-Calibration

We strongly recommend you to match the pressed position data with the displayed position data by calculating relative positions on your system, so-called User-Calibration. You need to make it at least for the initial use or the time of recognizing an offset between a pressed position and a displayed one for any touch panels, even though they are totally in the same design.

An example of User Calibration is shown below;

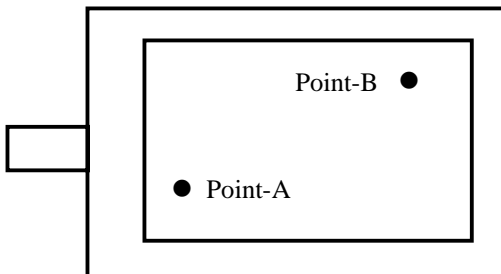

*Position data of point-A : (Xa,Ya)
 *Position data of point-B : (Xb,Yb)
 Presumption : Xa<Xb and Ya<Yb

*Displayed position of point-A : (DXa,DYa)
 *Displayed position of point-B : (DXb,DYb)
 Presumption : DXa<DXb and DYa<DYb

The constant value in direct proportion of the resolution between the touch panel and the display monitor in the X direction is;

$$CX=(DXb-DXa)/(Xb-Xa) \text{ ----- A)}$$

in the Y direction is;

$$CY=(DYb-DYa)/(Yb-Ya) \text{ ----- B)}$$

Consequently, the relationship between an arbitrary position on the touch panel(X_n, Y_n) and an displayed position on the monitor(DX_n, DY_n) is;

$$DX_n = DX_a + CX * (X_n - X_a) \text{ ----- C)}$$

$$DY_n = DY_a + CY * (Y_n - Y_a) \text{ ----- D)}$$

With the execution of Use Calibration, first of all, get the data X_a, Y_a, X_b, Y_b by pressing two points of the touch panel on the display monitor, and store them in the host system. Second of all, obtain the constant values of CX and CY from Eq.(A) and (B), and store them in the host system with DX_a and DY_a .

After all of those processes, you can obtain accurate pressed positions on the display monitor (DX_n, DY_n) by getting the pressed data (X_n, Y_n) and utilizing Eq.(C) and (D) while in ordinary operation. User Calibration should be done whenever you press the touch panel.

(2) Stop Mode

Stop Mode is a low power consumption mode that the touch panel controller is providing. In the case of setting Stop Mode on, it becomes in low power consumption state when not pressing the touch panel or not sending any commands to it for more than 30 seconds. During the state, no serial command is accepted. Sending Reset command or feeding a signal to SBSCAN terminal of the controller in low power consumption state make the controller resume. In the case of setting Stop Mode off, reading the reference voltages of Auto Calibration is made only when powering on or sending Reset command.

(3) Mouse Emulation

Gunze Electronics USA co. provides several device drivers for mouse emulation with PC/AT of IBM or IBM compatible computers and our controllers. Those drivers enable you to utilize the touch panel like a mouse on your system.

We are providing device drivers as follows;

Serial Communication (CRS1-656)

TT-DOS	under MS-DOS
TT-OS/2	under OS/2
TT-WIN	under Windows3.1
TT-WIN95	under Windows95/98
TT-WIN	under WindowsNT

PS/2 Communication (CRS1-685)

TT-WIN95PS/2	under Windows95/98
--------------	--------------------

12. Warranty

(1) Warranty Period

One year after delivery

(2) Warranty Clause

Within the warranty period, in such a case of malfunction or breakdown caused by Gunze's failure, the product is exchanged or repaired.

The following cases are exceptions to the warranty coverage.

- (i) After the product is delivered, such damage or breakdown from failing or collision which is caused by user's mishandling.
- (ii) Such damage or breakdown caused by natural or manmade disaster.
- (iii) Such damage or breakdown caused by alternation or repair of product which is made by the party other than Gunze.
- (iv) Such damage or breakdown caused by use or handling of the product in such a manner as against the instructions of this guide.

Note: The warranty is limited to only the product itself and does not cover any subsequent damage, breakdown or loss which might be caused by malfunction of the product. We can not repair or exchange of the product on the site it is installed.

*Sample Schematic for Serial Communication (CRS1-656)

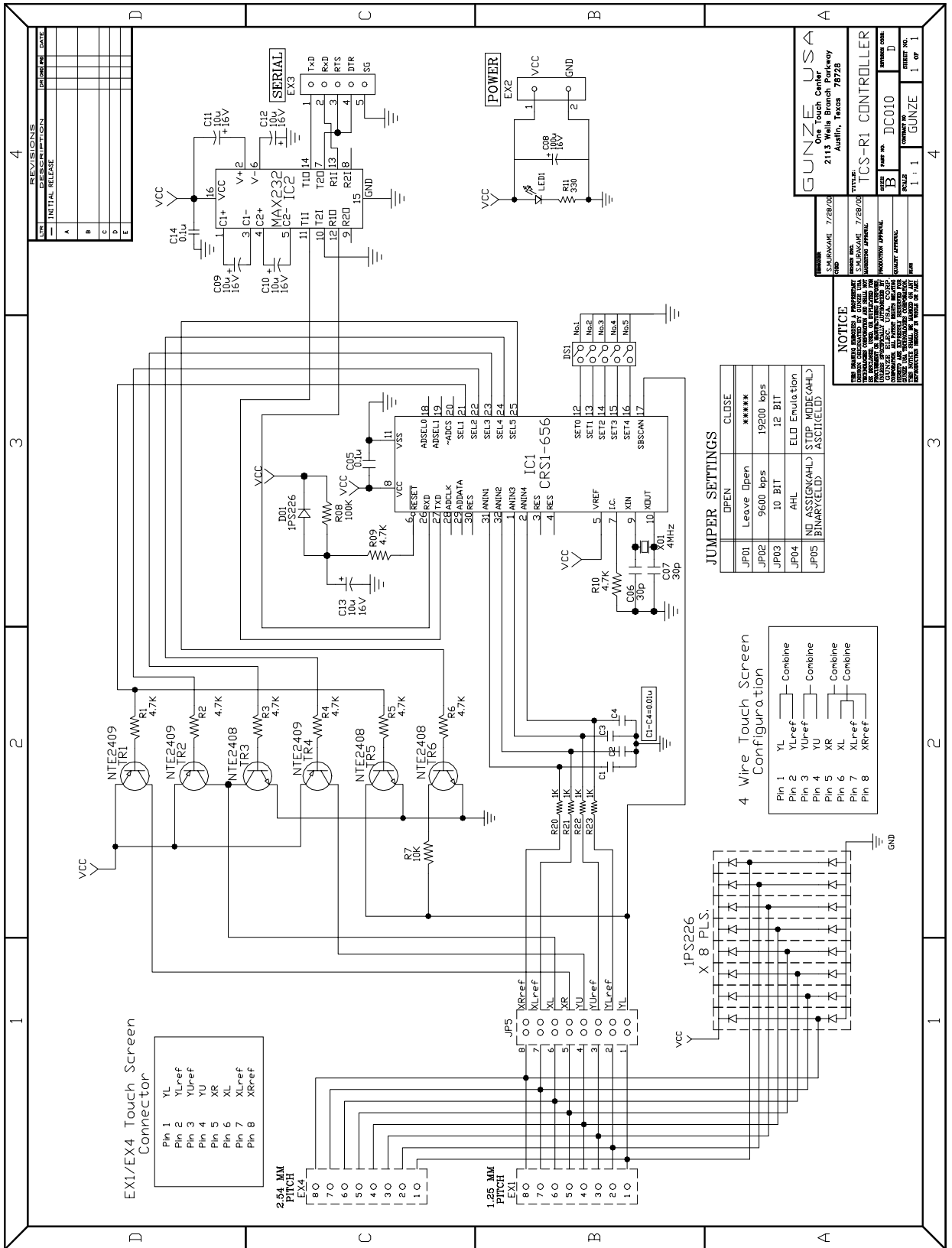

*Sample Schematic for PS/2 Communication (CRS1-685)

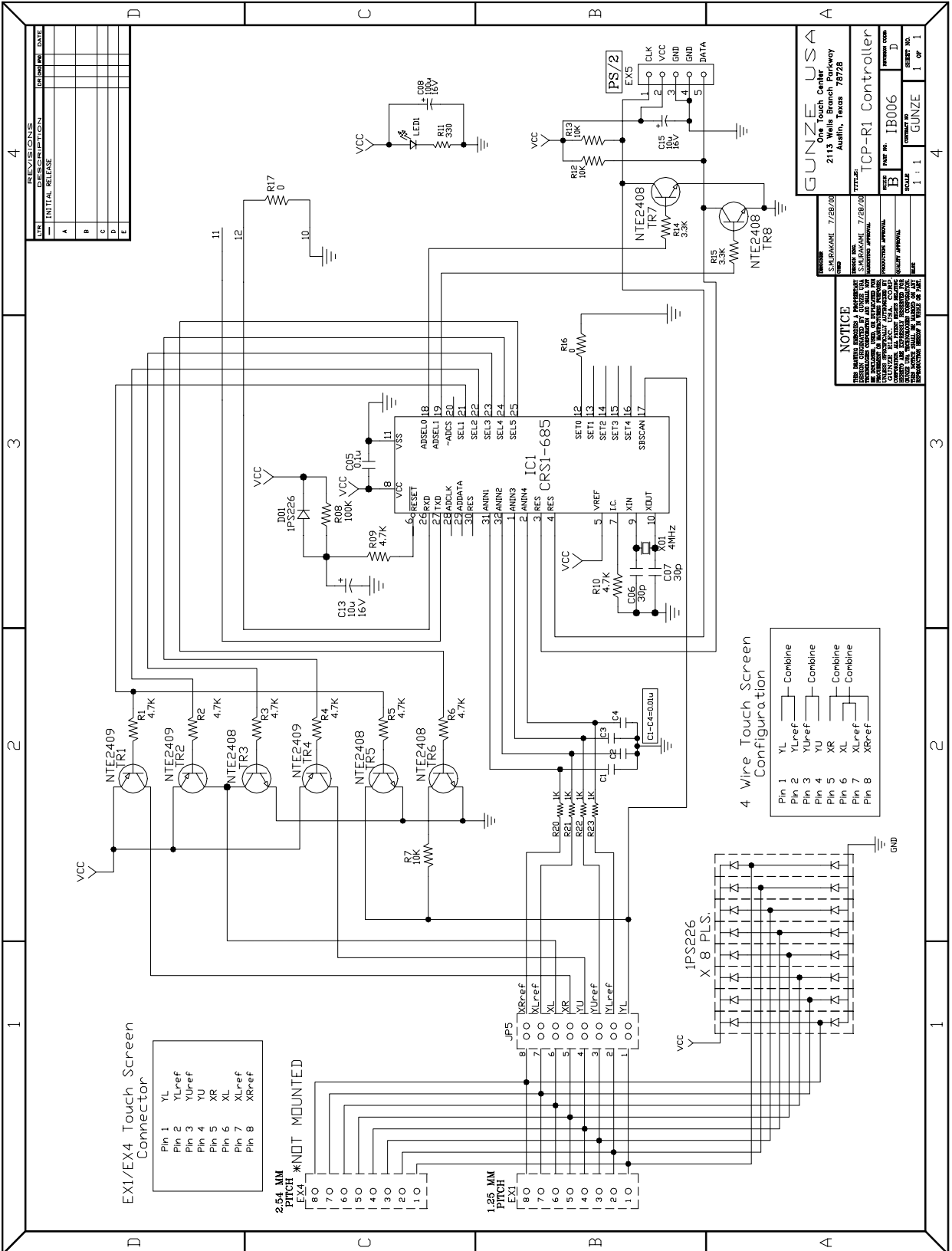

Appendixes

*Package Outline

32P6B-A

Plastic 32pin 7x7mm body LQFP

EIAJ Package Code	JEDEC Code	Weight(g)	Lead Material
LQFP32-P-77-0.80	-		Alloy 42

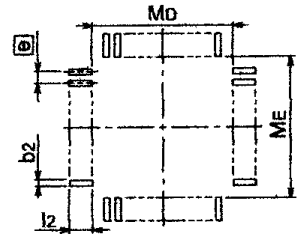
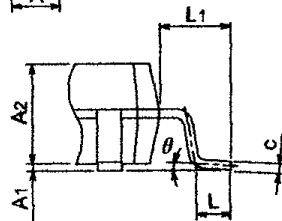
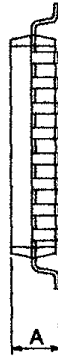
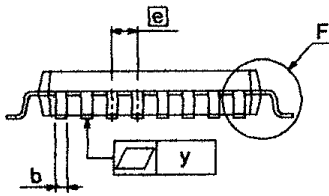
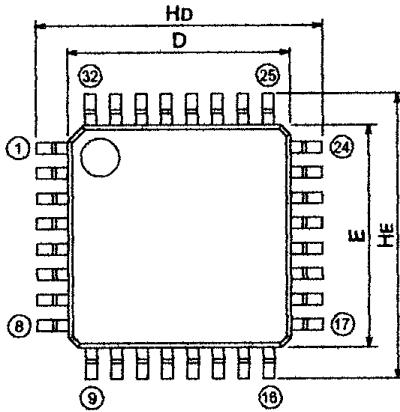

Recommended Mount Pad

Symbol	Dimension in Millimeters		
	Min	Nom	Max
A	-	-	1.7
A1	0	0.1	0.2
A2	-	1.4	-
b	0.3	0.35	0.45
c	0.105	0.125	0.175
D	6.9	7.0	7.1
E	6.9	7.0	7.1
e	-	0.8	-
HD	8.8	9.0	9.2
HE	8.8	9.0	9.2
L	0.3	0.5	0.7
L1	-	1.0	-
y	-	-	0.1
θ	0°	-	10°
b2	-	0.5	-
l2	1.0	-	-
MD	-	7.4	-
ME	-	7.4	-

Appendixes

*Storage and Soldering

SMT(Surface Mount Type) ICs are sensitive for thermal stress with package absorbing moisture. So you should keep them not to absorb ambient moisture before soldering. MP(Moisture Proof) bags prevent ICs from absorbing moisture during transportation and storage at warehouses or factories.

1. Storage

- The unopened MP bag kept at 5 to 40°C / 20 to 80%RH could prevent moisture within two years.
- After opening MP bags, you should store ICs at 30°C / 70%RH or under and solder them within four days.
- When you must open MP bags temporarily, opening time should be within ten minutes. And then, you should fold the opening side of bags into two and close them with adhesive tape.
- Over the time period above, you are recommended to bake ICs at 125°C in 20 to 24 hours before using. (Four times maximum, less than 96 hours totally)

2. Recommended temperature profile of soldering

(1) Reflow soldering method

As for Infrared Reflow and Air Reflow, see Fig-1, and as for VPS Reflow, see Fig-2. Those temperature profiles show the temperature on the IC surface. You can apply a maximum of four times.

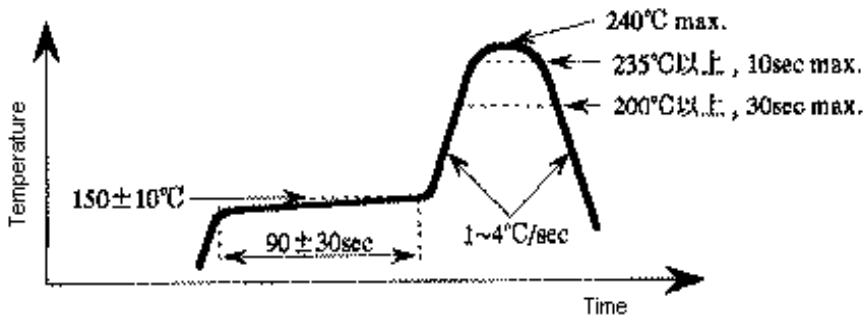

Fig-1 Temperature profile of Infrared Reflow and Air Reflow

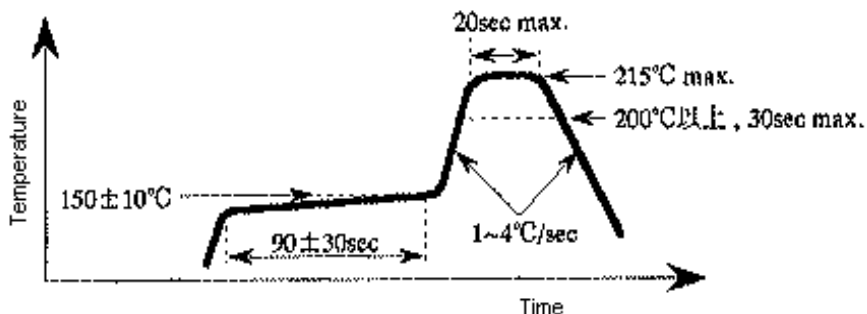

Fig-2 Temperature profile of VPS Reflow

(2) Wave soldering method

See Fig-3. The preheat temperature is depending on the type of flux.

The temperature profile shows the temperature on the IC surface.

You can apply just a time.

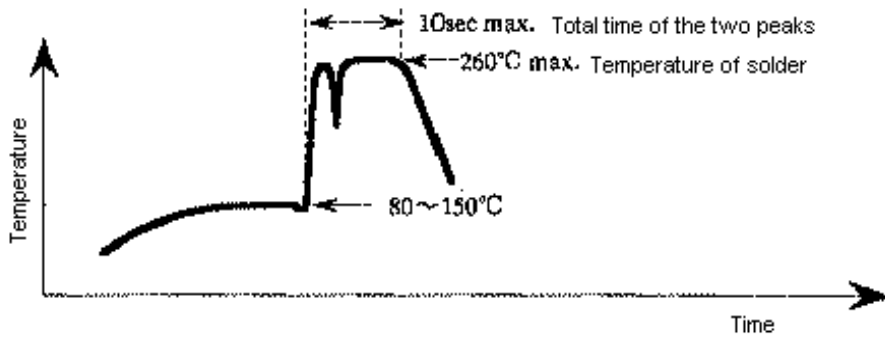

Fig-3 Temperature profile of Wave Soldering

3. Cleaning

If you need to clean the boards with solvents after soldering, you should pay attention to administrative guidance and regulation, residual ionic(non ionic) contamination, and solvent resistance of parts.