

Features

- Multiplexes eight 2.048 Mbit/s, ST-BUS links onto one serial high-speed 20.48 Mbit/s link
- 15.808 Mbit/s clear bandwidth transport
- Two 8 kbit/s and one 32 kbit/s oversampled signalling channels
- Embedded system timing and frame synchronization
- Frame buffer control signals generated on-chip
- Check-sum generated on multiplexed frame
- Remote synchronization indication
- Both master and slave timing mode operation
- On-chip reference generation for slave mode synchronization
- 4B/5B data encoding/decoding

Applications

- Fibre distributed systems
- Backplane concentrators
- Local Area Networks (LANs)

ISSUE 1

January 1995

Ordering Information

MT90710AP 84 Pin PLCC

0 °C to +70 °C

Description

The High-Speed Isochronous Multiplexer integrated circuit multiplexes up to eight Serial Telecom (ST-BUS) links onto a single 20 MHz loop to facilitate point-to-point data transport requirements. The MT90710 connects easily with standard Fiber Optic interfaces to form a complete electric to photonic conversion circuit. Optical transmission allows large bandwidth inter-shelf or, in distributed systems, inter-node communication by eliminating multiple data buses, cable inter-connect and attendant driver interfaces. The final result is a simple physical interface free of the radiated emissions and background noise susceptibility problems encountered in copper-wired environments.

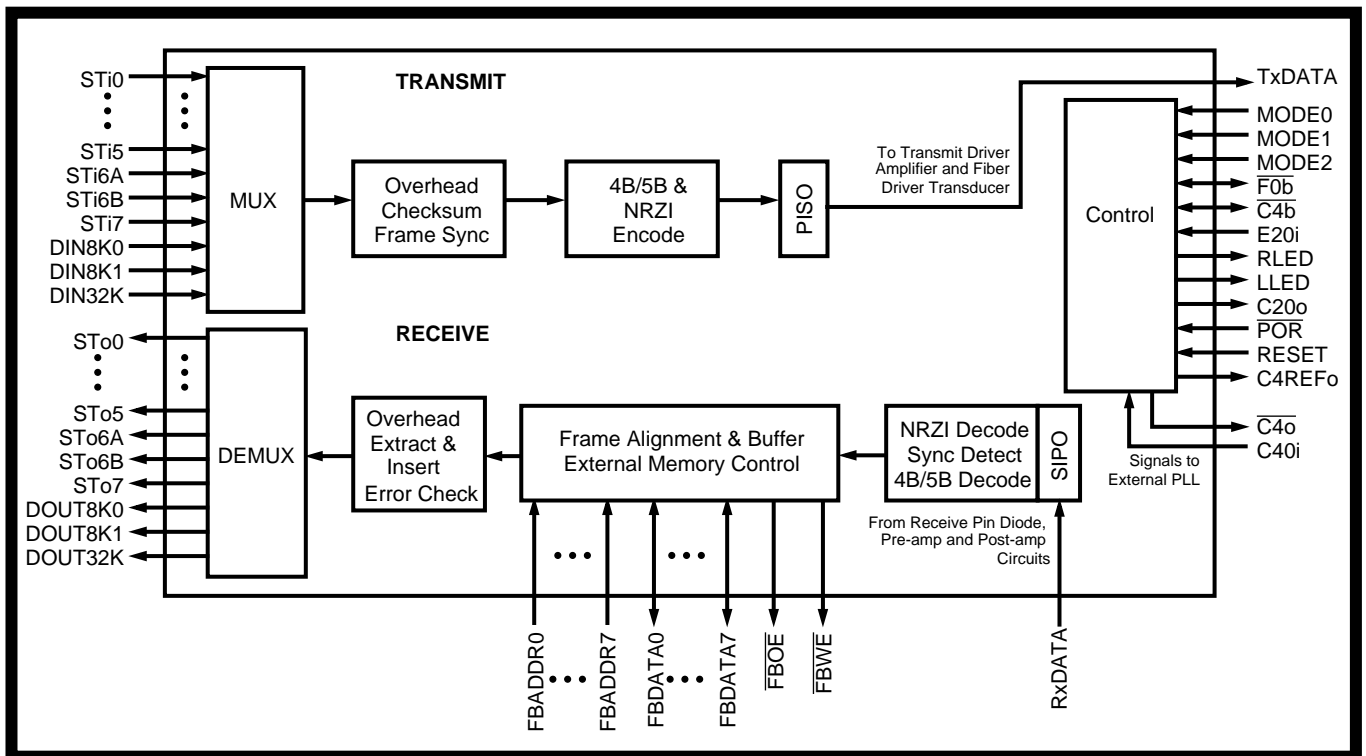

Figure 1 - Functional Block Diagram

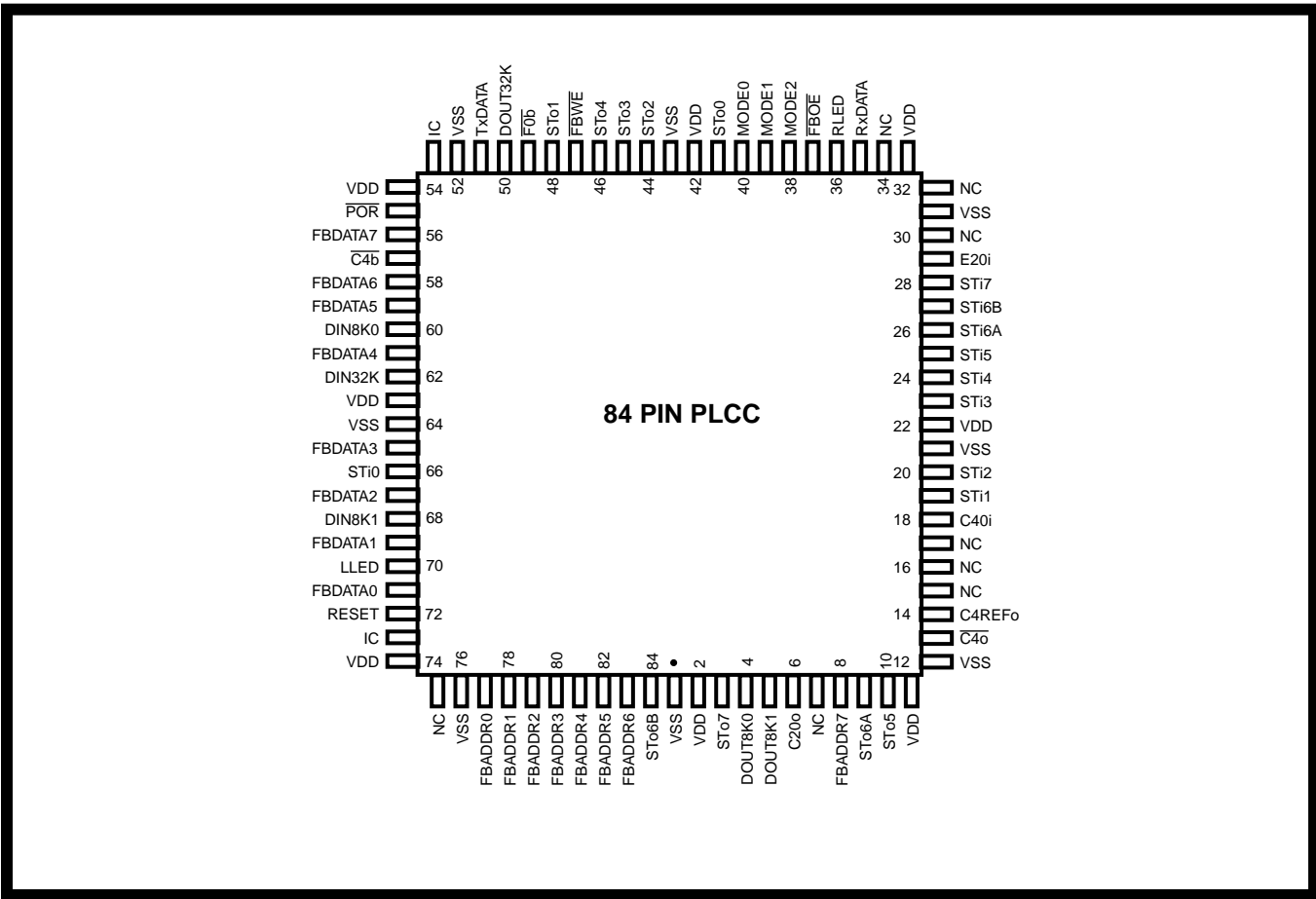

Figure 2 - Pin Connections

Pin Description

Pin #	Name	Description
1	V _{SS}	Power Supply Ground. Nominally 0 volts.
2	V _{DD}	Positive Power Supply. Nominally 5 volts.
3	ST07	Serial, 32 Channel, 2.048 Mb/s Link 7 (Output Type 3). Only channels 9 - 31 are available for user data transfer (1.474 Mb/s). Channels 0 - 8 (0.576 Mb/s) are reserved for access to fiber overhead information. Output is active only when the receiver detects the synchronization pattern on RxDATA input stream; output is high impedance during loss of synchronization.
4	DOUT8K0	Asynchronous 8 kHz Signal 0 (Output Type 3). Sourced from the far-end DIN8K0 input.
5	DOUT8K1	Asynchronous 8 kHz Signal 1 (Output Type 3). Sourced from the far-end DIN8K1 input.
6	C20o	20.48 MHz Clock (Output Type 3). Derived from transmit PLL 40.96 MHz clock divided by 2 (see pin 18). Made available for system use.
7	NC	No Internal Connection.
8	FBADDR7	Frame Buffer RAM Address Bit 7 (Output Type 2).
9	ST06A	Serial, 32 Channel, 2.048 Mb/s Link 6A (Output Type 3). Output is active only when the receiver detects the synchronization pattern on RxDATA input stream; output is high impedance during loss of synchronization.

Pin Description

Pin #	Name	Description
10	STo5	Serial, 32 Channel, 2.048 Mb/s Link 5 (Output Type 3). Output is active only when the receiver detects the synchronization pattern on RxDATA input stream; output is high impedance during loss of synchronization.
11	V _{DD}	Positive Power Supply. Nominally 5 volts.
12	V _{SS}	Power Supply Ground. Nominally 0 volts.
13	$\overline{C4o}$	4.096 MHz Clock (Output Type 3). Used by the transmit PLL. This clock is the input C40i (40.96MHz, see pin 18) master clock divided by 10 (inverted) and is fed back to the external PLL circuit as a reference.
14	C4REFo	4.096 MHz Reference Clock (Output Type 3). Used by transmit PLL. When in controller mode this clock is derived from the system $\overline{C4b}$ (4.096 MHz) clock input (see pin 57). When in peripheral mode this clock is extracted from the receive data on the fiber port.
15,16, 17	NC	No Internal Connection.
18	C40i	Transmit 40.96 MHz Clock (Input Type 2). Derived from the transmit PLL. This is the master clock used by the device.
19	STi1	Serial, 32 Channel, 2.048 Mb/s Link 1 (Input Type 1).
20	STi2	Serial, 32 Channel, 2.048 Mb/s Link 2 (Input Type 1).
21	V _{SS}	Power Supply Ground. Nominally 0 volts.
22	V _{DD}	Positive Power Supply. Nominally 5 volts.
23	STi3	Serial, 32 Channel, 2.048 Mb/s Link 3 (Input Type 1).
24	STi4	Serial, 32 Channel, 2.048 Mb/s Link 4 (Input Type 1).
25	STi5	Serial, 32 Channel, 2.048 Mb/s Link 5 (Input Type 1).
26	STi6A	Serial, 32 Channel, 2.048 Mb/s Link 6A (Input Type 1).
27	STi6B	Serial, 32 Channel, 2.048 Mb/s Link 6B (Input Type 1).
28	STi7	Serial, 32 Channel, 2.048 Mb/s Link 7 (Input Type 1). Only channels 9 - 31 are available for user data transfer (1.472 Mb/s). Data input on channels 0 - 8 (0.576 Mb/s) is ignored by the device. This bandwidth is reserved for fiber overhead information.
29	E20i	Receiver 20.96 MHz Clock (Input Type 2). Extracted clock from the receive data stream. Divided internally by 5 and phase corrected to frame synch pattern to produce internal 2.048 MHz data clock for parsing the receive STi streams.
30	NC	No Internal Connection.
31	V _{SS}	Power Supply Ground. Nominally 0 volts.
32	NC	No Internal Connection.
33	V _{DD}	Positive Power Supply. Nominally 5 volts.
34	NC	No Internal Connection.
35	RxDATA	Receive 4B/5B, NRZI Encoded Serial Data (Input Type 1).
36	RLED	"Remote Sync" LED Driver (Open Collector, Output Type 3). Drives the "Remote Sync" LED on/off at approximately a 4 Hz rate when the remote interface is not synchronized. Active only when the local interface is synchronized.
37	FBOE	Frame Buffer Ram Enable (Output Type 2). Generates a low going strobe during valid RAM read access.

Pin Description

Pin #	Name	Description
38	MODE2	Operating Mode Select 2 (Input Type 1). See Table 1.
39	MODE1	Operating Mode Select 1 (Input Type 1). See Table 1.
40	MODE0	Operating Mode Select 0 (Input Type 1). See Table 1.
41	STo0	Serial, 32 Channel, 2.048 Mb/s link 0 (Output Type 3). Output is active only when receiver detects the synchronization pattern on RxDATA input stream; output is high impedance during loss of synchronization.
42	V _{DD}	Positive Power Supply. Nominally 5 volts.
43	V _{SS}	Power Supply Ground. Nominally 0 volts.
44	STo2	Serial, 32 Channel, 2.048 Mb/s link 2 (Output Type 3). Output active only when receiver detects the synchronization pattern on RxDATA input stream; high impedance output during loss of synchronization.
45	STo3	Serial, 32 Channel, 2.048 Mb/s link 3 (Output Type 3). Output active only when receiver detects the synchronization pattern on RxDATA input stream; high impedance output during loss of synchronization.
46	STo4	Serial, 32 Channel, 2.048 Mb/s link 4 (Output Type 3). Output active only when receiver detects the synchronization pattern on RxDATA input stream; high impedance output during loss of synchronization.
47	FBWE	Frame Buffer RAM Write Enable (Output Type 2). Generates a low going strobe during valid RAM write access.
48	STo1	Serial, 32 Channel, 2.048 Mb/s link 1 (Output Type 3). Output active only when receiver detects the synchronization pattern on RxDATA input stream; high impedance output during loss of synchronization.
49	F _{0b}	System 8 kHz Reference Frame Pulse (Bi-directional; Input and Output Types 3). When in controller mode this is an input accepting the system reference pulse. In peripheral mode this is an output supplying the system an 8 kHz reference frame pulse.
50	DOUT32K	Asynchronous 32 kHz Signal 1 (Open Collector, Output Type 3). Sourced from the far-end DIN32K input.
51	TxDATA	Transmit 4B/5B, NRZI Encoded Serial Data (Output Type 3).
52	V _{SS}	Power Supply Ground. Nominally 0 volts.
53	IC	Internally Connected (Output Type 1). Drives continuous logic 1. Leave open circuit.
54	V _{DD}	Positive Power Supply. Nominally 5 volts.
55	POR	Power On Reset (Input Type 2). Active low.
56	FBDATA7	Frame Buffer Data Bit 7 (Bidirectional; Input Type 1 and Output Type 2). Data bit 7.
57	C _{4b}	4.096 MHz Reference Clock (Bidirectional; Input and Output Types 3). Input used by PLL in controller mode and derived from the system. In peripheral mode this is an output supplying the system 4.096 MHz reference clock.
58	FBDATA6	Frame Buffer Data Bit 6 (Bidirectional; Input Type 1 and Output Type 2). Data bit 6.
59	FBDATA5	Frame Buffer Data Bit 5 (Bidirectional; Input Type 1 and Output Type 2). Data bit 5.
60	DIN8K0	Asynchronous 8 kHz Signal 0 (Input Type 1). Transmitted to the far-end DOUT8K0 output.
61	FBDATA4	Frame Buffer Data Bit 4 (Bidirectional; Input Type 1 and Output Type 2). Data bit 4.

Pin Description

Pin #	Name	Description
62	DIN32K	Asynchronous 32 kHz Signal (Input Type 1). Transmitted to the far-end DOUT32K output.
63	V _{DD}	Positive Power Supply. Nominally 5 volts.
64	V _{SS}	Power Supply Ground. Nominally 0 volts.
65	FBDATA3	Frame Buffer Data Bit 3 (Bidirectional; Input Type 1 and Output Type 2). Data bit 3.
66	STi0	Serial, 32 Channel, 2.048 Mb/s Link 0 (Input Type 1).
67	FBDATA2	Frame Buffer Data Bit 2 (Bidirectional; Input Type 1 and Output Type 2). Data bit 2.
68	DIN8K1	Asynchronous 8 kHz Signal 1 (Input Type 1). Transmitted to the far-end DOUT8K1 output.
69	FBDATA1	Frame Buffer Data Bit 1 (Bidirectional; Input Type 1 and Output Type 2). Data bit 1.
70	LLED	"Local Sync" LED Driver (Open Collector, Output Type 2). Drives the "Local Sync" LED on/off at approximately a 4 Hz rate when the local interface is not in synchronization.
71	FBDATA0	Frame Buffer Data Bit 0 (Bidirectional; Input Type 1 and Output Type 2). Data bit 0.
72	RESET	Reset Control (Input Type 1).
73	IC	Internally Connected.
74	V _{DD}	Positive Power Supply. Nominally 5 volts.
75	NC	No Internal Connection.
76	V _{SS}	Power Supply Ground. Nominally 0 volts.
77	FBADDR0	Frame Buffer RAM Address Bit 0 (Output Type 2).
78	FBADDR1	Frame Buffer RAM Address Bit 1 (Output Type 2).
79	FBADDR2	Frame Buffer RAM Address Bit 2 (Output Type 2).
80	FBADDR3	Frame Buffer RAM Address Bit 3 (Output Type 2).
81	FBADDR4	Frame Buffer RAM Address Bit 4 (Output Type 2).
82	FBADDR5	Frame Buffer RAM Address Bit 5 (Output Type 2).
83	FBADDR6	Frame Buffer RAM Address Bit 6 (Output Type 2).
84	STo6B	Serial, 32 Channel, 2.048 Mb/s Link 6B (Output Type 3). Output active only when receiver detects the synchronization pattern on RxDATA input stream; high impedance output during loss of synchronization.

Notes:

All unused inputs should be connected to logic high or low unless otherwise stated. All outputs should be left open circuit when not used. All output types are CMOS with CMOS logic levels (see DC Electrical Characteristics for Type drive capability). Input Type 1 has TTL compatible logic levels, Type 2 has CMOS compatible logic levels and Type 3 has TTL Schmitt trigger compatible logic levels (see DC Electrical Characteristics).

Overview

The MT90710 multiplexes multiple Serial Telecom (ST-BUS timing, Figure 7) links onto a single 20 MHz loop to facilitate point-to-point data transport requirements. The MT90710 connects easily with standard Fiber Optic interfaces to form a complete electric to photonic conversion circuit. Optical

transmission allows large bandwidth inter-shelf or, in distributed systems, inter-node communication by eliminating multiple data busses, cable inter-connect and the attendant driver interfaces. The final result is a simple physical interface free of the radiated emissions and background noise susceptibility problems encountered in copper-wired environments.

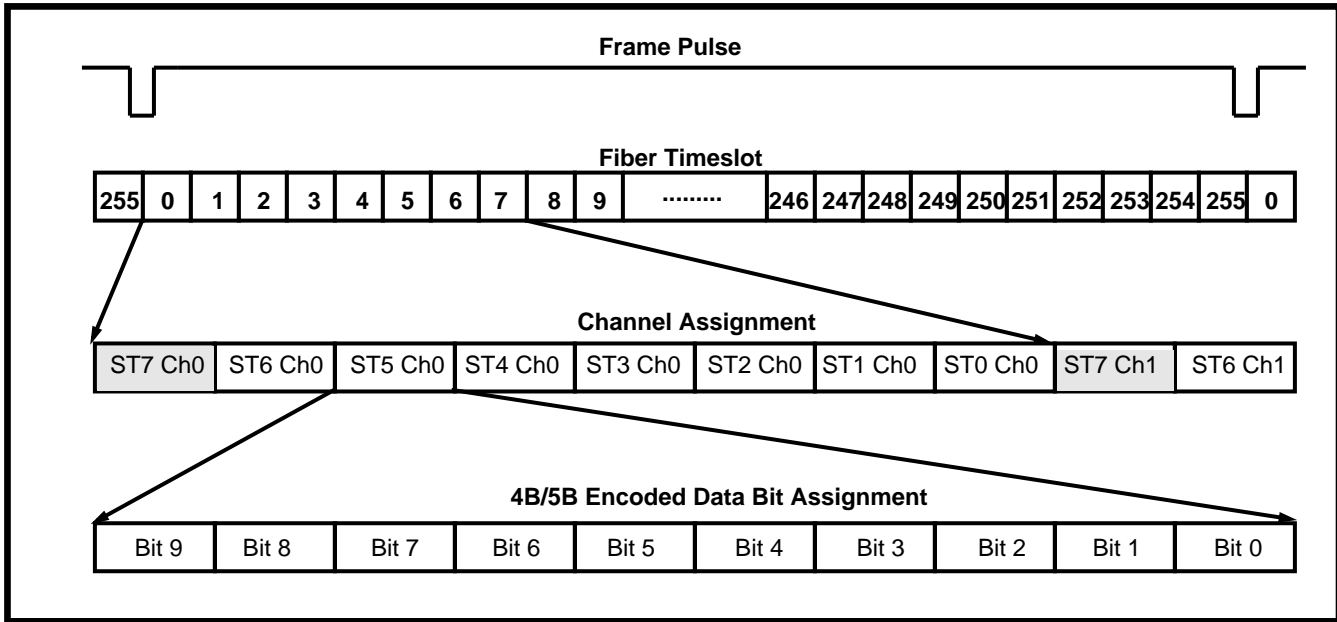

Figure 3 - Fiber Timeslot Assignment

The MT90710 provides 15.808 Mb/s clear channel, user bandwidth in both transmit and receive directions. In addition, two 8 kHz sampled signals and one 32 kHz sampled signal are encoded and transported over the loop as additional user bandwidth. These asynchronous signals, in combination with overhead information and clear channel bandwidth produce an aggregate data rate of 16.384 Mb/s. After encoding (4B/5B) the final transmitted baud rate is 20.48 Mbaud.

Once compiled, the contents of the transmit data bandwidth is first 4B/5B encoded, then NRZI encoded before it is applied to the transmit fiber interface driver via TxDATA. 4B/5B ensures that the NRZI encoded data will contain a minimum of two transitions per baud. This is sufficient to allow the far end to extract the embedded clock information. As a result of 4B/5B encoding the information bandwidth of 16.384 Mb/s increases to a total baud rate of 20.48 Mbaud/s at the fiber interface.

Transmit

The transmit data interface consists of nine ST-BUS input links and three asynchronously sampled input signals. These are STi0 - STi5, STi6A and STi6B, STi7, DIN8K0, DIN8K1 and DIN32K. Six ST-BUS input links, STi0-5, each provide 2.048 Mb/s transparent transmission bandwidth. With ST6MUX Mode disabled STi6A is also a 2.048 Mb/s link while STi6B is not used (see ST6MUX description). The first nine channels of the STi7 input are ignored leaving the remaining 23 channels for user bandwidth. This allows a total of 15.808 Mb/s clear bandwidth for application use. The first nine (576 kb/s) channels of STi7 are made available for transmitting the three asynchronous signals combined with fiber overhead information. This overhead is automatically compiled in the transmit interface and inserted into these timeslots for transmission over the fiber interface.

Incoming ST-BUS link data is latched at the mid-bit position of the internal timeslot. Since there is a phase difference between the internal and external timeslots, due to the operation of the PLL, latching occurs at approximately the 3/4 bit position of the external timeslot when in Controller mode. In Peripheral mode data is latched at the midpoint of the timeslot. Asynchronous signals DIN8K0-1 are sampled once per frame (8,000 times per second) and are intended to convey relatively static information where a state transition is not time critical enough that a resolution of one frame is detrimental. Asynchronous signal DIN32K is sampled four times per frame (32,000 times per second) and may be used to transport data at a higher rate than the other two asynchronous inputs. As an example, this sampling rate is sufficient to support 19.2K Baud RS-232 signals (TTL levels) so that remote programming or loop maintenance may be performed.

Overhead information includes a frame synchronization byte, an error count and a checksum calculated on the previous frame of transmitted data.

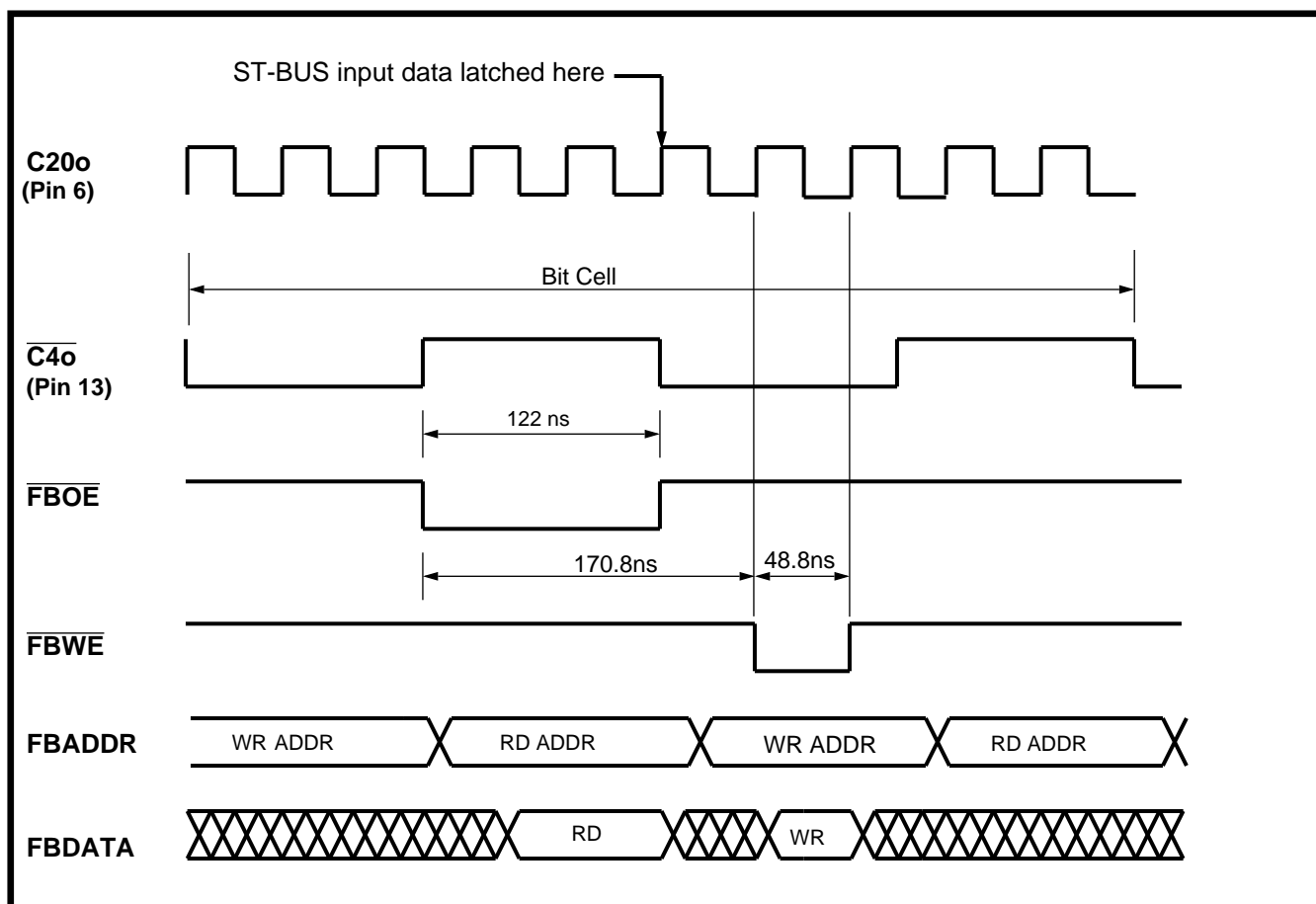

Figure 4 - Frame Buffer Memory Typical Timing

Receive

The 4B/5B and NRZI encoded data from the receive fiber interface is NRZI decoded and the frame synchronization information is extracted. After 4B/5B decoding the remaining data is frame aligned either to the system frame pulse (when in Controller Mode) or to the extracted frame pulse (when in Peripheral Mode). After alignment, the received data package is disassembled into the clear channel ST-BUS streams, the asynchronous signals and the overhead/status information. When ST6MUX mode is disabled, received 15.808 Mb/s bandwidth is made available on ST0-0-6A and the last 23 channels of ST0-7. The asynchronous signals are presented on DOUT8K0, DOUT8K1 and DOUT32K while the received overhead information, as well as local status information, is presented on ST0-7 in channels 0 to 7.

Control

An external, 40.96 MHz PLL provides the master clock (C40i) for the MT90710. This PLL uses either the system's C4b clock (pin 57) for reference when it's in controller mode or the extracted clock from the

receive data interface when it's in peripheral mode. Switching between these two primary references is automatic and under the control of the MODE0-2 pins. The selected reference is fed to the external PLL from the C4REFo output pin. The MT90710 also divides the 40.96 MHz master clock by ten and supplies this secondary reference to the external PLL on C4o for comparison to the primary reference. The PLL creates a 40.96 MHz master clock from a 4.096 MHz reference by multiplying by 10 and attenuates jitter present on the extracted reference.

The master clock is divided down to create internal clocks, external ST-BUS clocks (when in peripheral mode) and timeslot counters.

Control signals are also created for the transmitter and receiver. The transmitter timeslot counter is synchronized to the backplane frame pulse while the receiver timeslot counter is sync to the extracted synchronization pulse.

Frame Buffer

To re-align the received data from the fiber interface to the system, or node, a frame reference buffer is

required. This is implemented using an external 8x8 static RAM (35 ns). Only 256 bytes are used of the 8K total. RAM address and data (FBADDR0-7 and FBDATA0-7) signals are generated along with an output enable strobe ($\overline{\text{FBOE}}$) and a write enable strobe ($\overline{\text{FBWE}}$).

Mode #	Mode 2	Mode 1	Mode 0	ST6MUX	Configuration
0	0	0	0	ENABLED	CONTROLLER
1	0	0	1	ENABLED	PERIPHERAL
2	0	1	0	not used	not used
3	0	1	1	DISABLED	CONTROLLER
4	1	0	0	not used	not used
5	1	0	1	not used	not used
6	1	1	0	not used	not used
7	1	1	1	DISABLED	PERIPHERAL

Table 1 - Operational Mode Select

Overhead Information

Fiber Interface

Eight of the 256 fiber channels are reserved for overhead information. These are fiber channels:

Channel #	Function
0	Frame Alignment
8	Asynchronous signal transfer and synchronization detect
16	Checksum of previous frame
24	Reserved
32	Reserved
40	Reserved
48	Remote error count most significant byte
56	Remote error count least significant byte

ST-BUS Interface

The first nine STo7 channels are reserved for overhead information:

STo7 Channel	Function
0	not available
1	not available
2	Reserved
3	Local error count (most significant byte)
4	Local error count (least significant byte)
5	Reserved
6	Remote error count (most significant byte)
7	Remote error count (least significant byte)
8	synchronization detect (see STo7 channel 8 definition)

STo7 Channel 8 Definition:

B7	remote receiver is in frame synch when logic 1
B6	Local receiver is in frame synch when logic 1
B5, B4, B3	Reserved
B2, B1, B0	Reserved

ST6MUX

ST-BUS to Fiber

When ST6MUX is enabled the STi6A and STi6B input streams are alternately multiplexed onto the fiber link. (i.e., only half of the bandwidth of each link is utilized). The transmit pattern at the fiber interface is:

STi6A-Chan0,STi6B-Chan1,STi6A-Chan2,STi6B-Chan3,....,STi6B-Chan29,STi6A-Chan30,STi6B-Chan31

Multiplexed Stream	Chan 0	Chan 1	Chan 2	Chan 3	Chan 4	Chan 5	Chan 28	Chan 29	Chan 30	Chan 31
STo6A Data from STi6A	Chan 0	Chan 0	Chan 2	Chan 2	Chan 4	Chan 4	Chan 28	Chan 28	Chan 30	Chan 30
STo6B Data from STi6B	Chan 1	Chan 1	Chan 3	Chan 3	Chan 5	Chan 5	Chan 29	Chan 29	Chan 31	Chan 31

Table 2 - ST6MUX Channel Assignment

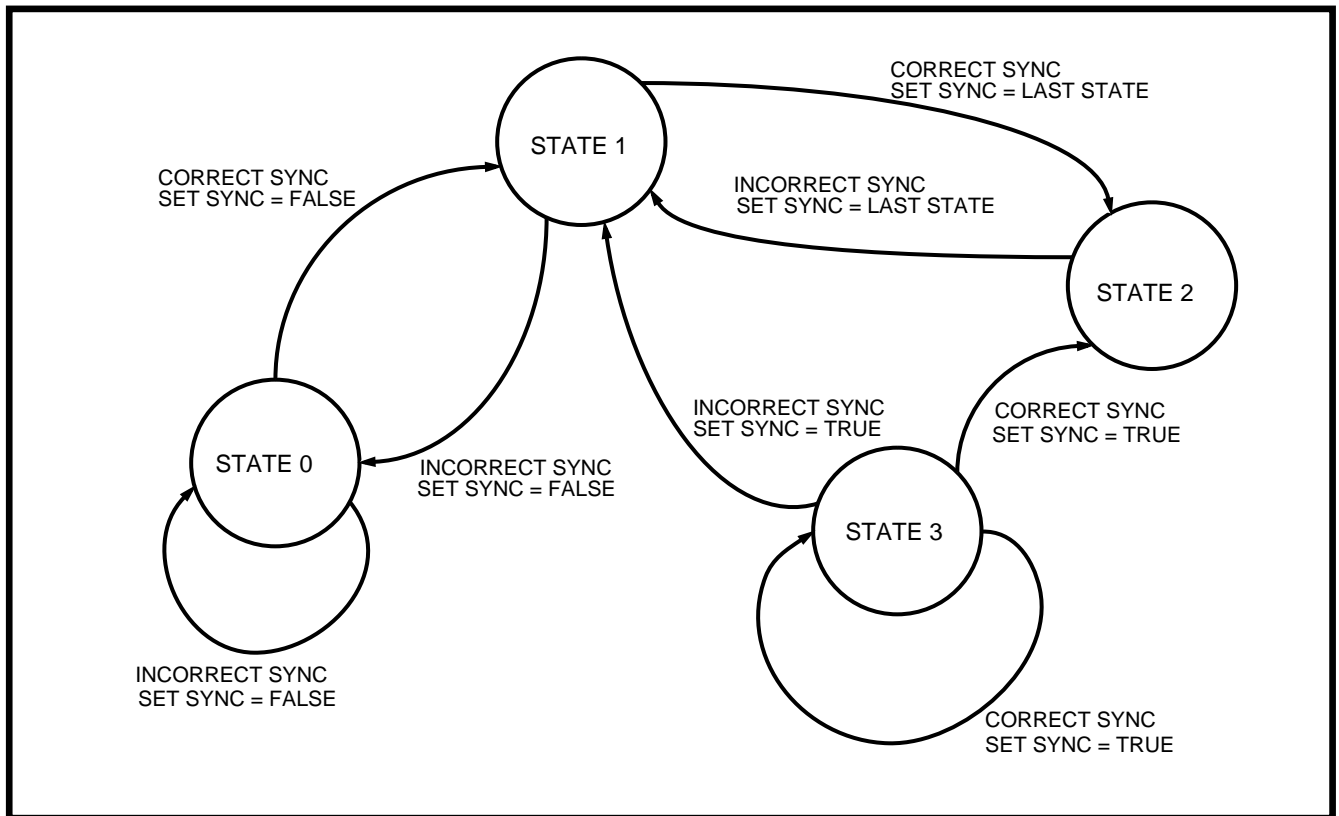

Figure 5 - State Diagram

Fiber to ST-BUS

When ST6MUX is enabled the STo6A and STo6B output streams are comprised of the demultiplexed information received from the fiber link. The received data is duplicated on two channels since the ST-BUS channels support twice the bandwidth of the data from the incoming fiber link. See Table 2.

When ST6MUX is disabled the STi6B and STo6B ports are not operational. The STi6A and STo6A ports operate as clear 2.048 MHz links in the same manner as STi/o links 0 to 5.

Fiber Loop Synchronization

A receiver is declared in synchronization after detection of three consecutive frames containing a valid sync pattern. Once synchronized a receiver will lose sync if a valid sync pattern is not detected in two of four consecutive frames (refer to Figure 5).

LED Control

The open collector RLED output (pin 36) will cause an LED, pulled up to +5 volts, to flash at

approximately a 4 Hz rate when the far-end is out of synchronization but the near-end is synchronized. If the near-end is not synchronized this output is inactive.

The open collector LLED output (pin 70) will cause an LED, pulled up to +5 volts, to flash at approximately a 4 Hz rate when the near-end is out of synchronization.

Checksum Generator

Checksum =

$$\sum_{i=1}^{255} DATA_i + C_{i-1}$$

Where i-1 is the carry out from the previous operation. The checksum is calculated on all 255 channels except on channel 0 where the frame synchronization code is transported. During this channel the previous checksum is stored and the register initialized for the next calculation.

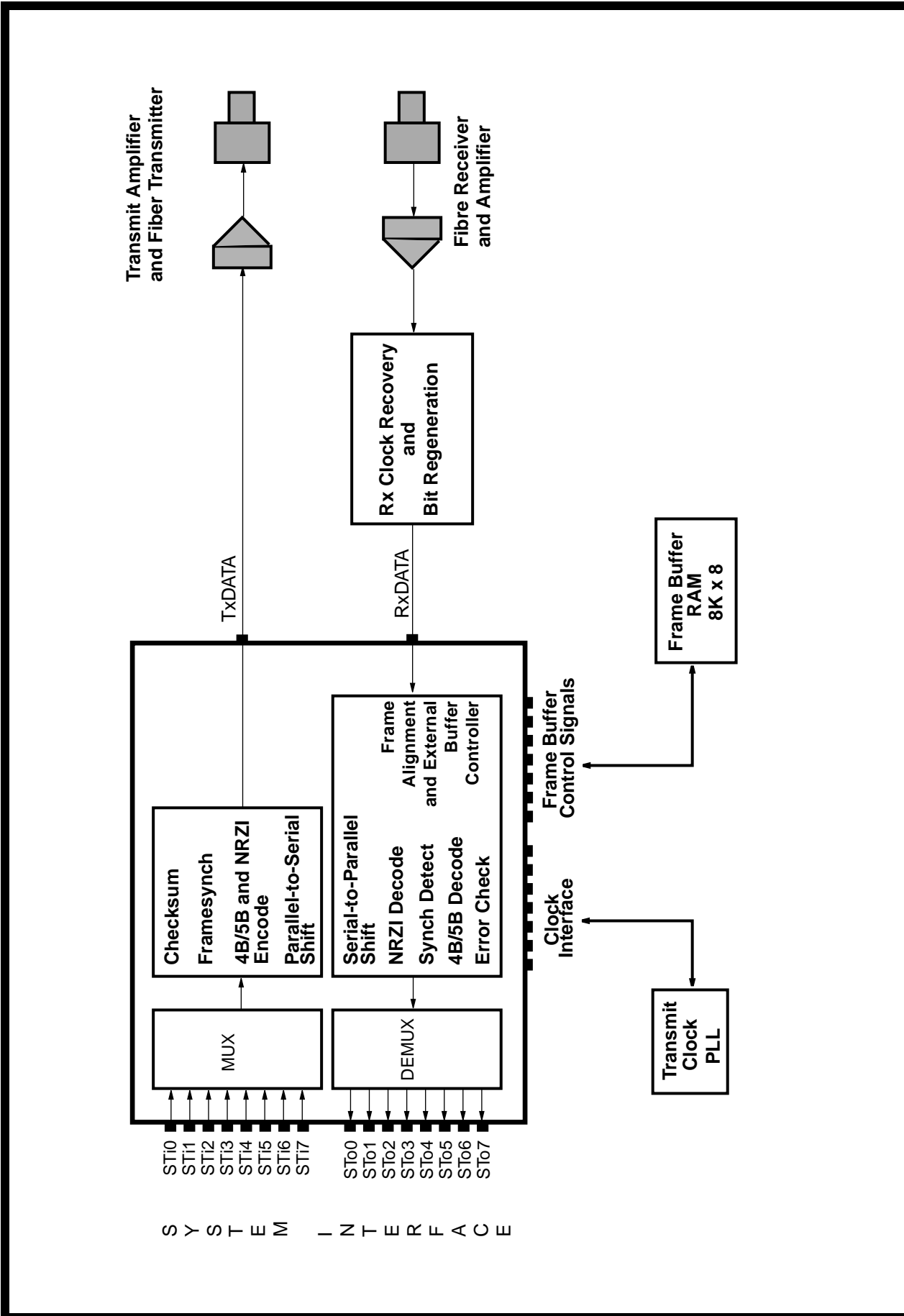

Figure 6 - Typical Fibre Interface Application

Absolute Maximum Ratings*

	Parameter	Symbol	Min	Max	Units
1	DC Supply Voltage	V_{DD}	- 0.3	7	V
2	Input Voltage	V_i	$V_{SS} - 0.3$	$V_{DD} + 0.3$	V
3	DC Input Current	I_i		+/- 50	mA
4	Storage Temperature	T_{stg}	- 65	+ 150	°C

* Exceeding these figures may cause permanent damage. Functional operation under these conditions is not guaranteed.

Recommended Operating Conditions

	Characteristics	Sym	Min	Typ	Max	Units	Test Conditions
1	Input Voltage	V_{DD}	4.5		5.5	V	
2	Operating Temperature	T_{OP}	0		+70	°C	

DC Electrical Characteristics - Voltages are with respect to ground (V_{SS}) unless otherwise stated.

	Characteristics	Sym	Min	Typ [‡]	Max	Units	Test Conditions
1	Supply Current operating	I_{DD}		230	276	mA	
2	Input HIGH voltage (TTL)	V_{IHT}	2.0			V	Input Type 1
3	Input LOW voltage (TTL)	V_{ILT}			0.8	V	Input Type 1
4	Input HIGH voltage (CMOS)	V_{IHC}	$0.7V_{DD}$			V	Input Type 2
5	Input LOW voltage (CMOS)	V_{ILC}			$0.3V_{DD}$	V	Input Type 2
6	Positive threshold (schmitt)	V_+			2.0	V	Input Type 3
7	Negative threshold (schmitt)	V_-	0.8			V	Input Type 3
8	Hysteresis	V_H		0.5		V	Input Type 3
9	Input leakage current	I_{IH}/I_{IL}			150	μA	$V_{DD}=5.5V$, $V_{IN}=V_{SS}$ to V_{DD}
10	High level output voltage	V_{OH}	3.7			V	All output types @ max I
11	Low level output voltage	V_{OL}			0.4	V	All output types @ max I
12	Output Current	I_{O1} I_{O4} I_{O12}	1 4 12			mA mA mA	Output Type 1 Output Type 2 Output Type 3
13	High impedance leakage	I_{OZ}			20	μA	$V_{DD}=5.5V$, $V_{IN}=V_{SS}$ to V_{DD}
14	Output capacitance	C_o			20	pF	
15	Input capacitance	C_i		7	20	pF	

‡ Typical figures are at 25°C and are for design aid only: not guaranteed and not subject to production testing.

AC Electrical Characteristics† - ST-BUS Timing

Voltages are with respect to ground (V_{SS}) unless otherwise stated.

	Characteristics	Sym	Min	Typ‡	Max	Units	Test Conditions
1	Frame Pulse width	t_{FOiW}		244		ns	
2	Frame Pulse setup time	t_{FOiS}	10		190	ns	
3	Frame Pulse hold time	t_{FOiH}	20		190	ns	
4	STo delay Active to Active	t_{DAA}		45	100	ns	$C_L=150$ pF
5	STi setup time	t_{STiS}	20			ns	
6	STi hold time	t_{STiH}	20			ns	
7	Clock period	t_{C4i}	200	244	300	ns	
8	CK Input Low	t_{CL}	85	122	150	ns	
9	CK Input High	t_{CH}	85	122	150	ns	
10	Clock Rise/Fall Time	t_r, t_f			10	ns	

† Timing is over recommended temperature & power supply voltages ($V_{DD}=5V\pm 10\%$, $V_{SS}=0V$, $T_A=0$ to $70^\circ C$).

‡ Typical figures are at $25^\circ C$ and are for design aid only: not guaranteed and not subject to production testing.

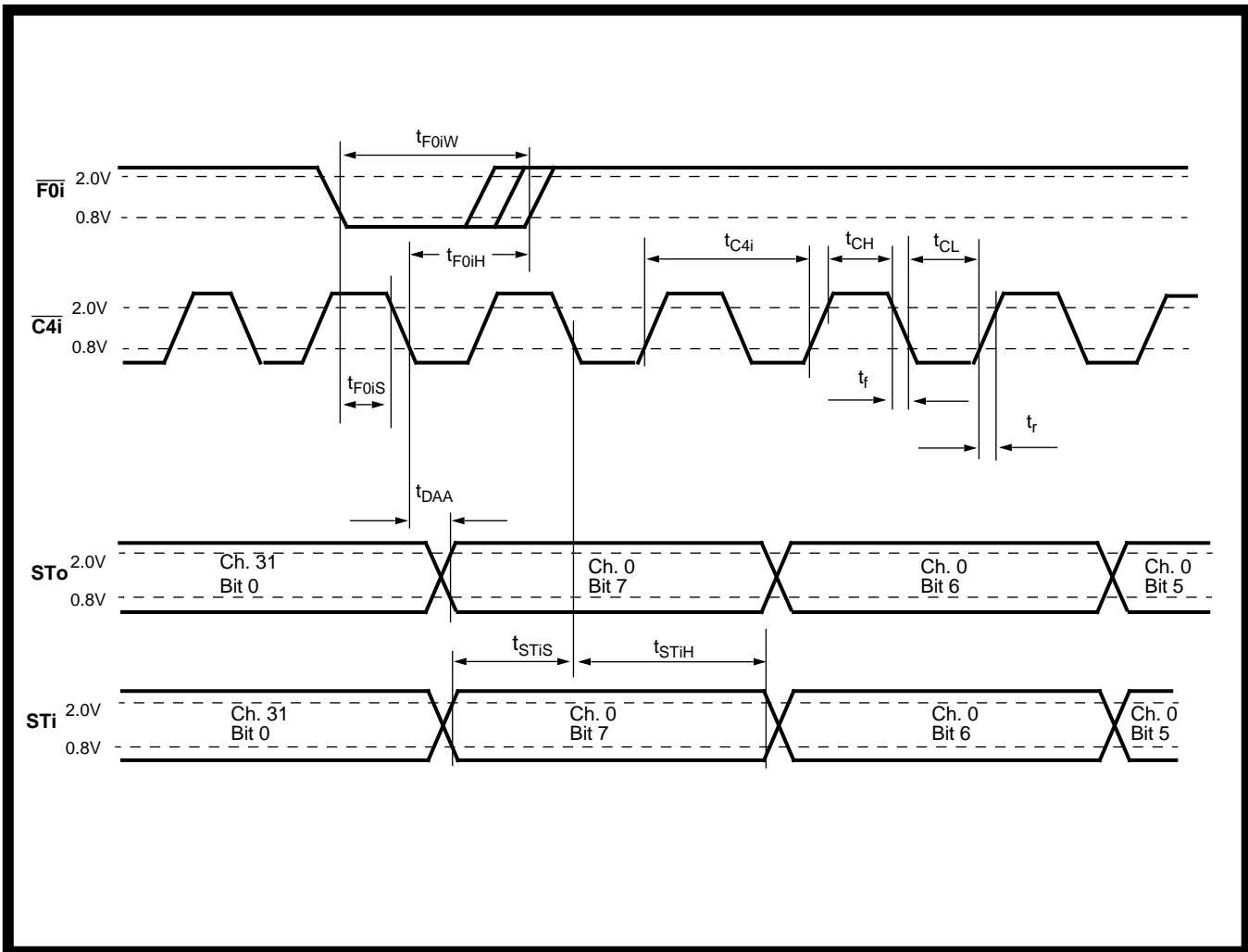

Figure 7 - ST-BUS Timing



**For more information about all Zarlink products
visit our Web Site at
www.zarlink.com**

Information relating to products and services furnished herein by Zarlink Semiconductor Inc. trading as Zarlink Semiconductor or its subsidiaries (collectively "Zarlink") is believed to be reliable. However, Zarlink assumes no liability for errors that may appear in this publication, or for liability otherwise arising from the application or use of any such information, product or service or for any infringement of patents or other intellectual property rights owned by third parties which may result from such application or use. Neither the supply of such information or purchase of product or service conveys any license, either express or implied, under patents or other intellectual property rights owned by Zarlink or licensed from third parties by Zarlink, whatsoever. Purchasers of products are also hereby notified that the use of product in certain ways or in combination with Zarlink, or non-Zarlink furnished goods or services may infringe patents or other intellectual property rights owned by Zarlink.

This publication is issued to provide information only and (unless agreed by Zarlink in writing) may not be used, applied or reproduced for any purpose nor form part of any order or contract nor to be regarded as a representation relating to the products or services concerned. The products, their specifications, services and other information appearing in this publication are subject to change by Zarlink without notice. No warranty or guarantee express or implied is made regarding the capability, performance or suitability of any product or service. Information concerning possible methods of use is provided as a guide only and does not constitute any guarantee that such methods of use will be satisfactory in a specific piece of equipment. It is the user's responsibility to fully determine the performance and suitability of any equipment using such information and to ensure that any publication or data used is up to date and has not been superseded. Manufacturing does not necessarily include testing of all functions or parameters. These products are not suitable for use in any medical products whose failure to perform may result in significant injury or death to the user. All products and materials are sold and services provided subject to Zarlink's conditions of sale which are available on request.

Purchase of Zarlink's I²C components conveys a licence under the Philips I²C Patent rights to use these components in an I²C System, provided that the system conforms to the I²C Standard Specification as defined by Philips.

Zarlink and the Zarlink Semiconductor logo are trademarks of Zarlink Semiconductor Inc.

Copyright 2002, Zarlink Semiconductor Inc. All Rights Reserved.

TECHNICAL DOCUMENTATION - NOT FOR RESALE
