



# STU13NC50

N-CHANNEL 500V - 0.31Ω - 13A Max220

PowerMesh™II MOSFET

TYPE	V <sub>DSS</sub>	R <sub>DS(on)</sub>	I <sub>D</sub>
STU13NC50	500V	< 0.4 Ω	13 A

- TYPICAL R<sub>DS(on)</sub> = 0.31Ω
- EXTREMELY HIGH dv/dt CAPABILITY
- 100% AVALANCHE TESTED
- NEW HIGH VOLTAGE BENCHMARK
- GATE CHARGE MINIMIZED

### DESCRIPTION

The PowerMESH™II is the evolution of the first generation of MESH OVERLAY™. The layout refinements introduced greatly improve the Ron\*area figure of merit while keeping the device at the leading edge for what concerns switching speed, gate charge and ruggedness.

### APPLICATIONS

- HIGH CURRENT, HIGH SPEED SWITCHING
- UNINTERRUPTIBLE POWER SUPPLIES (UPS)
- DC-AC CONVERTERS FOR TELECOM, INDUSTRIAL, AND LIGHTING EQUIPMENT

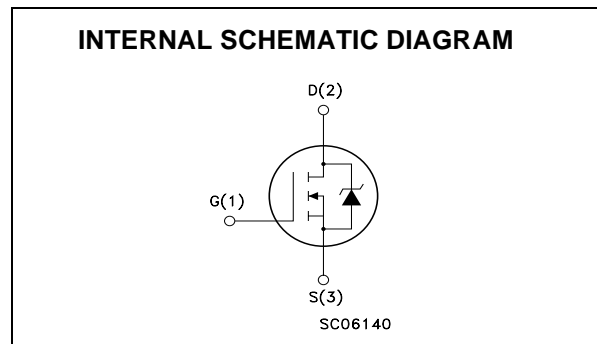
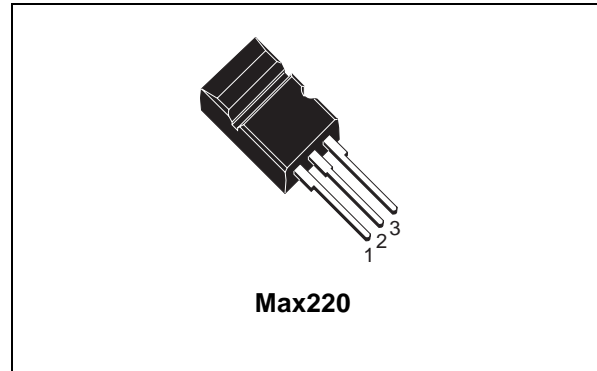

### ABSOLUTE MAXIMUM RATINGS

Symbol	Parameter	Value	Unit
V <sub>DS</sub>	Drain-source Voltage (V <sub>GS</sub> = 0)	500	V
V <sub>DGR</sub>	Drain-gate Voltage (R <sub>GS</sub> = 20 kΩ)	500	V
V <sub>GS</sub>	Gate- source Voltage	±30	V
I <sub>D</sub>	Drain Current (continuous) at T <sub>C</sub> = 25°C	13	A
I <sub>D</sub>	Drain Current (continuous) at T <sub>C</sub> = 100°C	8	A
I <sub>DM</sub> (●)	Drain Current (pulsed)	52	A
P <sub>TOT</sub>	Total Dissipation at T <sub>C</sub> = 25°C	160	W
	Derating Factor	1.28	W/°C
dv/dt(1)	Peak Diode Recovery voltage slope	3.5	V/ns
T <sub>stg</sub>	Storage Temperature	-65 to 150	°C
T <sub>j</sub>	Max. Operating Junction Temperature	150	°C

(\*)Pulse width limited by safe operating area

(1)I<sub>SD</sub> ≤ 13A, di/dt ≤ 130A/μs, V<sub>DD</sub> ≤ V<sub>(BR)DSS</sub>, T<sub>j</sub> ≤ T<sub>JMAX</sub>.

## STU13NC50

### THERMAL DATA

Rthj-case	Thermal Resistance Junction-case Max	0.78	°C/W
Rthj-amb	Thermal Resistance Junction-ambient Max	62.5	°C/W
T <sub>l</sub>	Maximum Lead Temperature For Soldering Purpose	300	°C

### AVALANCHE CHARACTERISTICS

Symbol	Parameter	Max Value	Unit
I <sub>AR</sub>	Avalanche Current, Repetitive or Not-Repetitive (pulse width limited by T <sub>j</sub> max)	13	A
E <sub>AS</sub>	Single Pulse Avalanche Energy (starting T <sub>j</sub> = 25 °C, I <sub>D</sub> = I <sub>AR</sub> , V <sub>DD</sub> = 50 V)	800	mJ

### ELECTRICAL CHARACTERISTICS (TCASE = 25 °C UNLESS OTHERWISE SPECIFIED)

OFF

Symbol	Parameter	Test Conditions	Min.	Typ.	Max.	Unit
V <sub>(BR)DSS</sub>	Drain-source Breakdown Voltage	I <sub>D</sub> = 250 μA, V <sub>GS</sub> = 0	500			V
I <sub>DSS</sub>	Zero Gate Voltage Drain Current (V <sub>GS</sub> = 0)	V <sub>DS</sub> = Max Rating V <sub>DS</sub> = Max Rating, T <sub>C</sub> = 125 °C			1 50	μA μA
I <sub>GSS</sub>	Gate-body Leakage Current (V <sub>DS</sub> = 0)	V <sub>GS</sub> = ±30V			±100	nA

ON (1)

Symbol	Parameter	Test Conditions	Min.	Typ.	Max.	Unit
V <sub>GS(th)</sub>	Gate Threshold Voltage	V <sub>DS</sub> = V <sub>GS</sub> , I <sub>D</sub> = 250 μA	2	3	4	V
R <sub>DS(on)</sub>	Static Drain-source On Resistance	V <sub>GS</sub> = 10V, I <sub>D</sub> = 7 A		0.31	0.4	Ω

### DYNAMIC

Symbol	Parameter	Test Conditions	Min.	Typ.	Max.	Unit
g <sub>fs</sub>	Forward Transconductance	V <sub>DS</sub> > I <sub>D(on)</sub> × R <sub>DS(on)max</sub> , I <sub>D</sub> = 7A		13		S
C <sub>iss</sub>	Input Capacitance	V <sub>DS</sub> = 25V, f = 1 MHz, V <sub>GS</sub> = 0		1970		pF
C <sub>oss</sub>	Output Capacitance			300		pF
C <sub>rss</sub>	Reverse Transfer Capacitance			48		pF

**ELECTRICAL CHARACTERISTICS (CONTINUED)**

**SWITCHING ON**

Symbol	Parameter	Test Conditions	Min.	Typ.	Max.	Unit
$t_{d(on)}$	Turn-on Delay Time	$V_{DD} = 250V, I_D = 7 A$		20		ns
$t_r$	Rise Time	$R_G = 4.7\Omega, V_{GS} = 10V$ (see test circuit, Figure 3)		23		ns
$Q_g$	Total Gate Charge	$V_{DD} = 400V, I_D = 14 A,$		75	105	nC
$Q_{gs}$	Gate-Source Charge	$V_{GS} = 10V$		10		nC
$Q_{gd}$	Gate-Drain Charge			38		nC

**SWITCHING OFF**

Symbol	Parameter	Test Conditions	Min.	Typ.	Max.	Unit
$t_{r(Voff)}$	Off-voltage Rise Time	$V_{DD} = 400V, I_D = 14 A,$		25		ns
$t_f$	Fall Time	$R_G = 4.7\Omega, V_{GS} = 10V$ (see test circuit, Figure 5)		30		ns
$t_c$	Cross-over Time			62		ns

**SOURCE DRAIN DIODE**

Symbol	Parameter	Test Conditions	Min.	Typ.	Max.	Unit
$I_{SD}$	Source-drain Current				13	A
$I_{SDM} (2)$	Source-drain Current (pulsed)				52	A
$V_{SD} (1)$	Forward On Voltage	$I_{SD} = 14 A, V_{GS} = 0$			1.4	V
$t_{rr}$	Reverse Recovery Time	$I_{SD} = 14 A, di/dt = 100A/\mu s,$		670		ns
$Q_{rr}$	Reverse Recovery Charge	$V_{DD} = 100V, T_j = 150^\circ C$ (see test circuit, Figure 5)		6.7		$\mu C$
$I_{RRM}$	Reverse Recovery Current			20		A

Note: 1. Pulsed: Pulse duration = 300  $\mu s$ , duty cycle 1.5 %.  
2. Pulse width limited by safe operating area.

**Safe Operating Area**

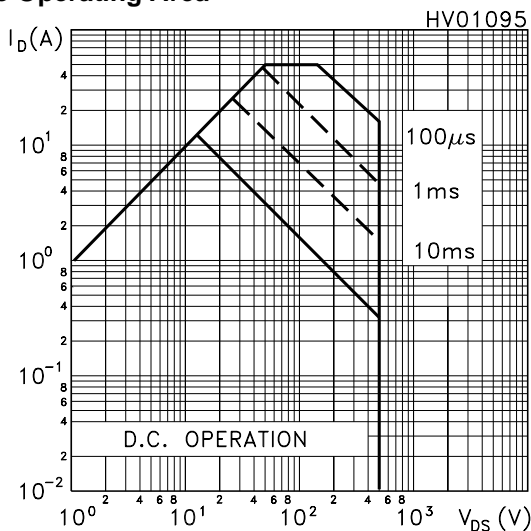

**Thermal Impedance**

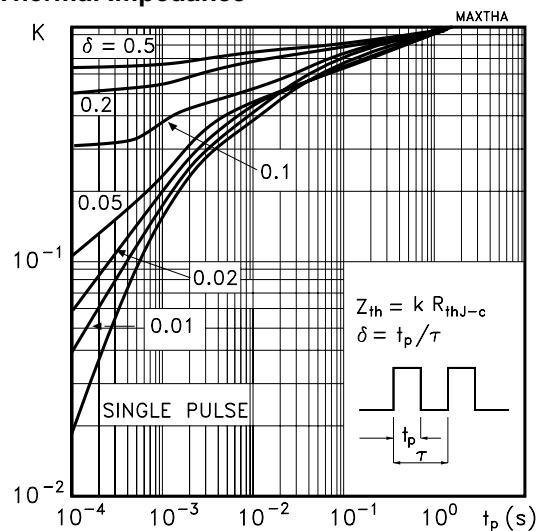

Output Characteristics

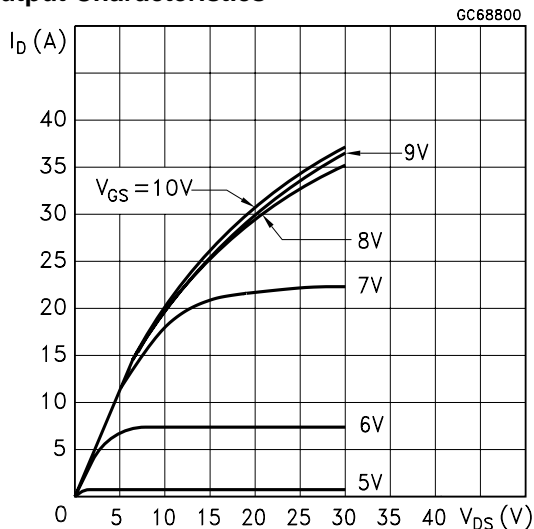

Transfer Characteristics

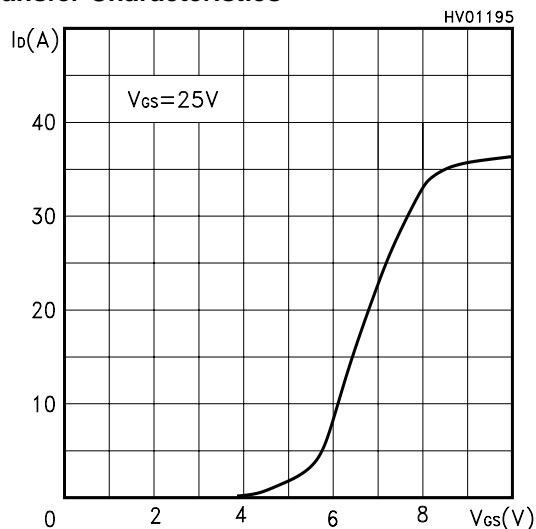

Transconductance

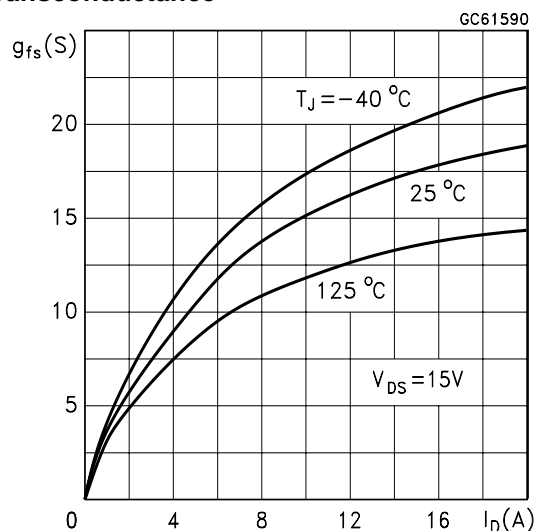

Static Drain-source On Resistance

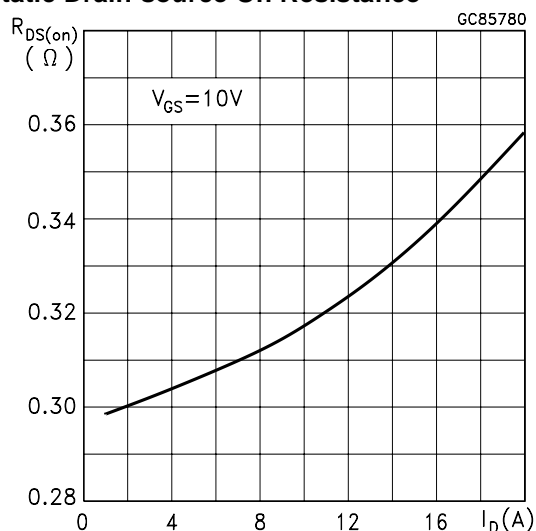

Gate Charge vs Gate-source Voltage

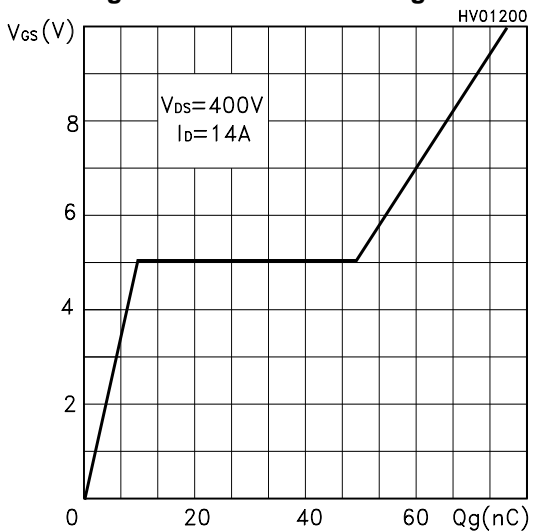

Capacitance Variations

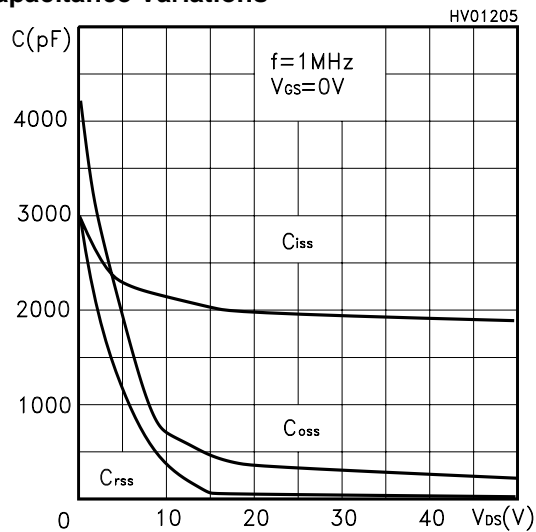

Normalized Gate Threshold Voltage vs Temperature

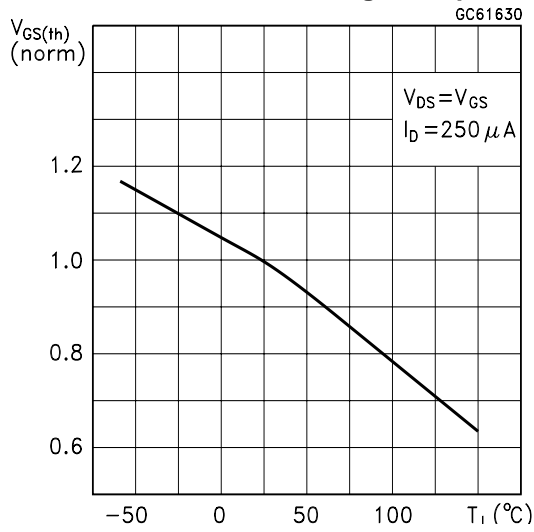

Normalized On Resistance vs Temperature

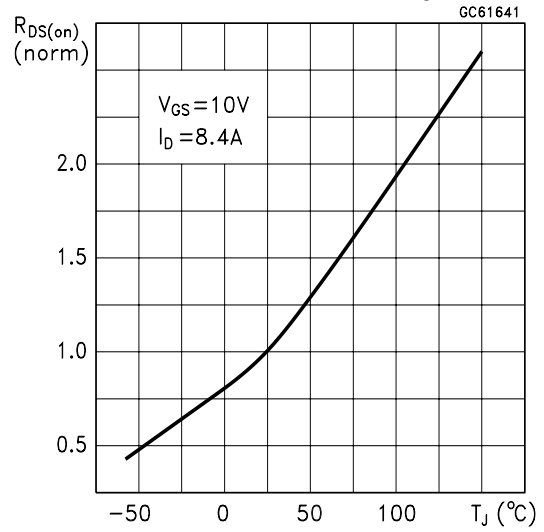

Source-drain Diode Forward Characteristics

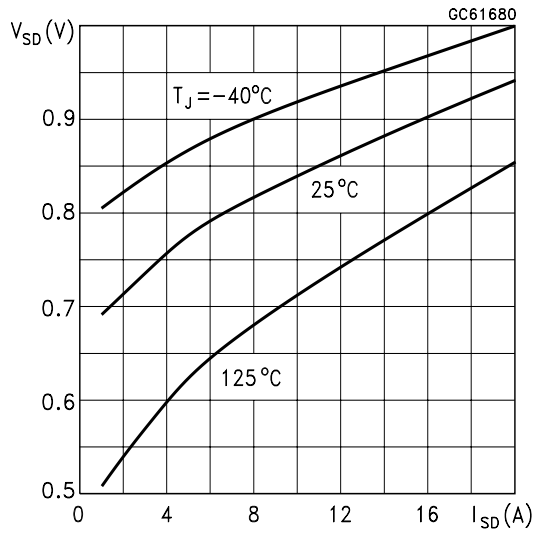



**Max220 MECHANICAL DATA**

DIM.	mm			inch		
	MIN.	TYP.	MAX.	MIN.	TYP.	MAX.
A	4.3		4.6	0.169		0.181
A1	2.2		2.4	0.087		0.094
A2	2.9		3.1	0.114		0.122
b	0.7		0.93	0.027		0.036
b1	1.25		1.4	0.049		0.055
b2	1.2		1.38	0.047		0.054
c	0.45		0.6		0.18	0.023
D	15.9		16.3		0.626	0.641
D1	9		9.35	0.354		0.368
D2	0.8		1.2	0.031		0.047
D3	2.8		3.2	0.110		0.126
e	2.44		2.64	0.096		0.104
E	10.05		10.35	0.396		0.407
L	13.2		13.6	0.520		0.535
L1	3		3.4	0.118		0.133

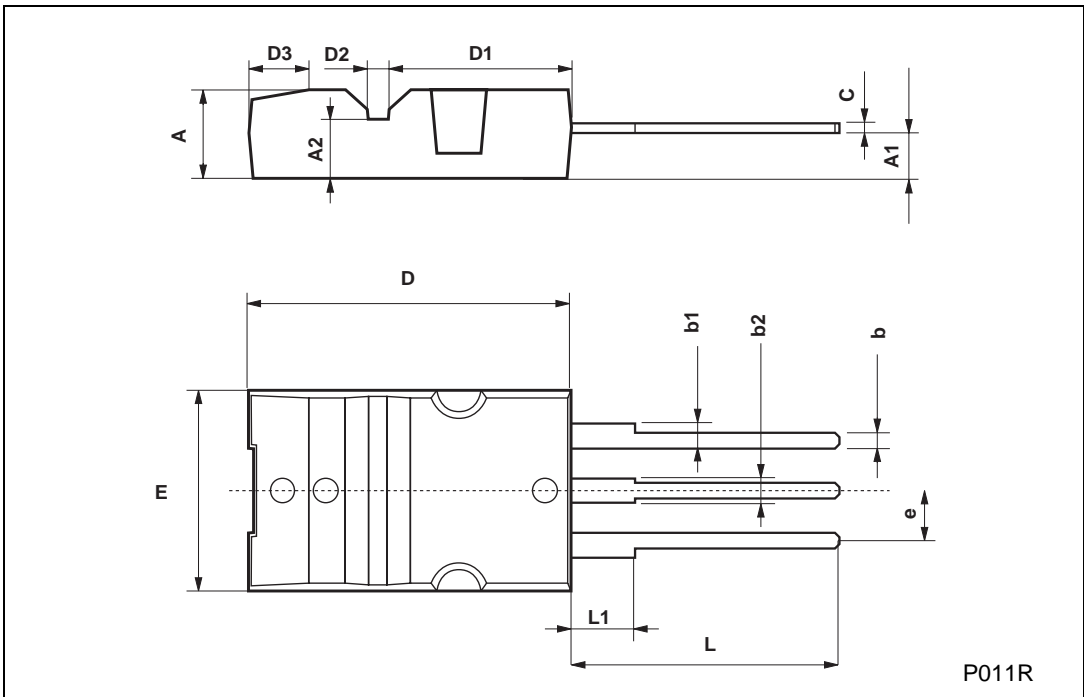

Information furnished is believed to be accurate and reliable. However, STMicroelectronics assumes no responsibility for the consequences of use of such information nor for any infringement of patents or other rights of third parties which may result from its use. No license is granted by implication or otherwise under any patent or patent rights of STMicroelectronics. Specifications mentioned in this publication are subject to change without notice. This publication supersedes and replaces all information previously supplied. STMicroelectronics products are not authorized for use as critical components in life support devices or systems without express written approval of STMicroelectronics.

The ST logo is registered trademark of STMicroelectronics  
© 2000 STMicroelectronics - All Rights Reserved

All other names are the property of their respective owners.

STMicroelectronics GROUP OF COMPANIES  
Australia - Brazil - China - Finland - France - Germany - Hong Kong - India - Italy - Japan - Malaysia - Malta - Morocco -  
Singapore - Spain - Sweden - Switzerland - United Kingdom - U.S.A.

<http://www.st.com>