

Low I_Q , Low Dropout 300mA Fixed Voltage Regulator

Features

- Low Quiescent Current : 60 μ A (No load)
- Low Dropout Voltage : 400mV (@300mA)
- Fixed Output Voltage : 1.5V ~ 4.5V by step 0.1V increment
- Stable with 1 μ F Output Capacitor
- Stable with Aluminum, Tantalum or Ceramic Capacitors .
- No Protection Diodes Needed
- Built in Thermal Protection
- Built in Current Limit Protection
- Controlled Short Circuit Current : 50mA
- Fast Transient Response
- Short Setting Time
- SOT-23 ,SOT-23-5 and SOT-89 Packages

Applications

- 5V to 3.3~4.5V Linear Regulators
- 3.3V to 1.5~2.5V Linear Regulators
- CD-ROM, CD-R/W and DVD Player
- Networking System, LAN Card, ADSL/Cable Modem, Cable Set-Top Box
- PC Peripherals

General Description

The APL5308/9 series are micropower, low dropout linear regulators, which operate from 2.7V to 6V input voltage and deliver up to 300mA. Typical dropout voltage is only 400mV at 300mA loading. Designed for use in battery-powered system, the low 60 μ A quiescent current makes it an ideal choice. Design with an internal P-channel MOSFET pass transistor, the APL5308/9 maintain a low supply current, independent of the load current and dropout voltage. Other features include thermal-shutdown protection current limit protection to ensure specified output current and controlled short-circuit current. The APL5308/9 regulators come in a miniature SOT-23, SOT-23-5 and SOT-89 packages.

Pin Configuration

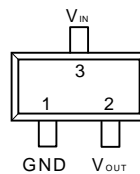

SOT-23 (Top View)
APL5308

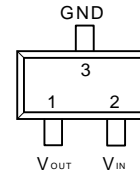

SOT-23 (Top View)
APL5309

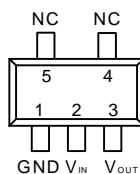

SOT-23-5 (Top View)
APL5308

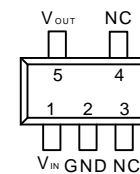

SOT-23-5 (Top View)
APL5309

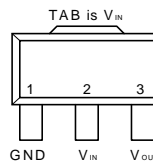

SOT-89 (Top View)
APL5308

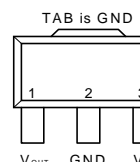

SOT-89 (Top View)
APL5309

ANPEC reserves the right to make changes to improve reliability or manufacturability without notice, and advise customers to obtain the latest version of relevant information to verify before placing orders.

Ordering and Marking Information

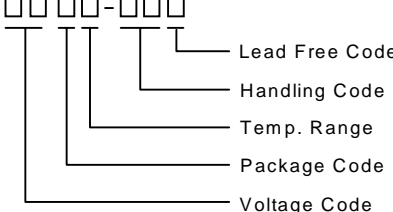
<p>APL5308/9 - □□□□-□□□□</p>  <p>Lead Free Code Handling Code Temp. Range Package Code Voltage Code</p>	<p>Package Code A : SOT-23 B : SOT-23-5 D : SOT-89 Temp. Range C : 0 to 70°C Handling Code TR : Tape & Reel Voltage Code : 15 : 1.5V ~ 45 : 4.5V Lead Free Code L : Lead Free Device Blank : Original Device</p>
<p>APL5308/9 -15 D : APL5308/9 XXXXX 15</p>	<p>XXXXXX - Date Code ; 15 - 1.5V</p>

Marking Information

SOT-23 and SOT-23-5 packages

Product Name	Marking	Product Name	Marking
APL5308-15A/B	389X	APL5309-15A/B	399X
APL5308-16A/B	38AX	APL5309-16A/B	39AX
APL5308-17A/B	38BX	APL5309-17A/B	39BX
APL5308-18A/B	38CX	APL5309-18A/B	39CX
APL5308-19A/B	38DX	APL5309-19A/B	39DX
APL5308-20A/B	38EX	APL5309-20A/B	39EX
APL5308-21A/B	38FX	APL5309-21A/B	39FX
APL5308-22A/B	38GX	APL5309-22A/B	39GX
APL5308-23A/B	38HX	APL5309-23A/B	39HX
APL5308-24A/B	38IX	APL5309-24A/B	39IX
APL5308-25A/B	38JX	APL5309-25A/B	39JX
APL5308-26A/B	38KX	APL5309-26A/B	39KX
APL5308-27A/B	38LX	APL5309-27A/B	39LX
APL5308-28A/B	38MX	APL5309-28A/B	39MX
APL5308-29A/B	38NX	APL5309-29A/B	39NX
APL5308-30A/B	38OX	APL5309-30A/B	39OX
APL5308-31A/B	38PX	APL5309-31A/B	39PX
APL5308-32A/B	38QX	APL5309-32A/B	39QX
APL5308-33A/B	38RX	APL5309-33A/B	39RX
APL5308-34A/B	38SX	APL5309-34A/B	39SX
APL5308-35A/B	38TX	APL5309-35A/B	39TX
APL5308-43A/B	38UX	APL5309-43A/B	39UX
APL5308-45A/B	38VX	APL5309-45A/B	39VX

The last character "X" in the marking is for data code.

Pin Description

PIN		I/O	Description
No.	Name		
1	V _{IN}	I	Supply voltage input.
2	GND		Ground pins of the circuitry, and all ground pins must be soldered To PCB with proper power dissipation.
3	V _{OUT}	O	Output pin of the regulator.

Absolute Maximum Ratings

Symbol	Parameter	Rating	Unit
V _{IN} , V _{OUT}	Input Voltage or Out Voltage	6.5	V
R _{TH,JA}	Thermal Resistance – Junction to Ambient	SOT-23 : 260 SOT-23-5 : 260 SOT-89 : 180	°C/W
R _{TH,JC}	Thermal Resistance – Junction to Case	SOT-23 : 130 SOT-23-5 : 130 SOT-89 : 38	°C/W
P _D	Power Dissipation	Internally Limited	W
T _J	Operating Junction Temperature		°C
	Control Section	0 to 125	
	Power Transistor	0 to 150	
T _{STG}	Storage Temperature Range	-65 to +150	°C
T _L	Lead Temperature (Soldering, 10 second)	260	°C

Electrical Characteristics

Unless otherwise noted these specifications apply over full temperature, C_{IN}=C_{OUT}=1μF, T_J=0 to 125°C. Typical values refer to T_J=25°C.

Symbol	Parameter	Test Conditions	APL5308/9			Unit
			Min.	Typ.	Max.	
V _{IN}	Input Voltage		2.7		6	V
V _{OUT}	Output Voltage	V _{OUT} +1.0V < V _{CC} < 6.0V, 0mA < I _{OUT} <	V _{OUT} -2%	V _{OUT}	V _{OUT} +2%	V
I _{LIMIT}	Circuit Current Limit	V _{IN} =V _{OUT} +1V		650		mA
I _{SHORT}	Short Current	V _{OUT} =0V		50		mA
I _{OUT}	Load Current	V _{IN} =V _{OUT} +1V	300			mA
REG _{LINE}	Line Regulation	V _{OUT} +1V < V _{CC} < 6.0V, I _{OUT} =1mA		1	10	mV
REG _{LOAD}	Load Regulation	V _{IN} = V _{OUT} +1V, 0mA < I _{OUT} < I _{MAX}		10	25	mV
	Load Transient	V _{IN} = V _{OUT} +1V , I _{OUT} =1mA-300mA in 1μs		150	250	mV

Electrical Characteristics (Cont.)

Unless otherwise noted these specifications apply over full temperature, $C_{IN}=C_{OUT}=1\mu F$, $T_J=0$ to $125^\circ C$. Typical values refer to $T_J=25^\circ C$.

Symbol	Parameter	Test Conditions	APL5308/9			Unit	
			Min.	Typ.	Max.		
V_{DROP}	Dropout Voltage ^(Note1)	$I_{OUT} = 300mA$	$1.5V \leq V_{OUT} < 2.0V$		1	1.2	V
			$2.0V \leq V_{OUT} < 2.5V$		0.8	0.9	
			$2.5V \leq V_{OUT} < 3V$		0.6	0.7	
			$3V \leq V_{OUT} \leq 3.5V$		0.4	0.5	
PSRR	Ripple Rejection	$F \leq 1kHz$, $1V_{pp}$ at $V_{IN} = V_{OUT} + 1.0V$	45	55		dB	
I_Q	Quiescent Current	No load		60	100	μA	
		$I_{OUT} = 300mA$		450	500		
OTS	Over Temperature			150		$^\circ C$	
	Over Temperature	Hysteresis		30		$^\circ C$	
TC	Output Voltage Temperature Coefficient			50		ppm/ $^\circ C$	
C_{OUT}	Output Capacitor			2.2		μF	
	ESR		0.01	0.1	1	Ohm	

Note1 : Dropout voltage definition : $V_{IN} - V_{OUT}$ when V_{OUT} is 2% below the value of V_{OUT} for $V_{IN} = V_{OUT} + 1V$

Application Circuit

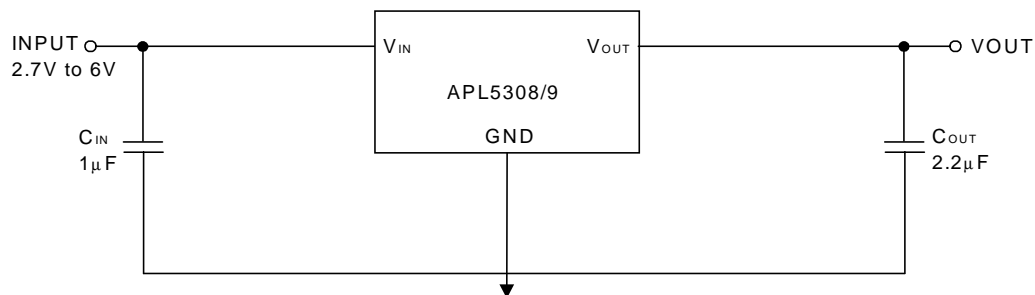

Typical Characteristics

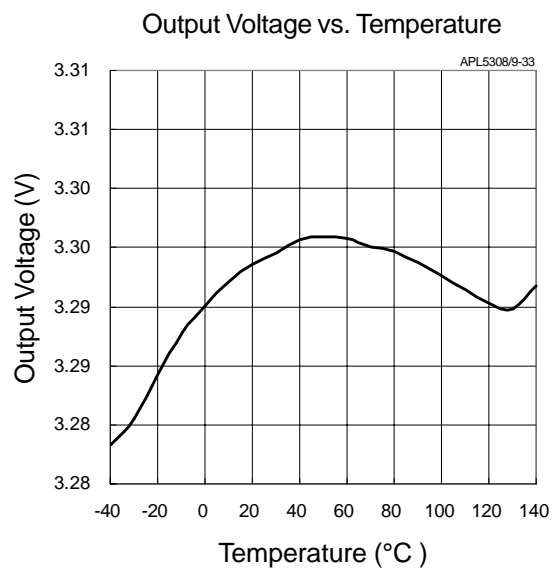
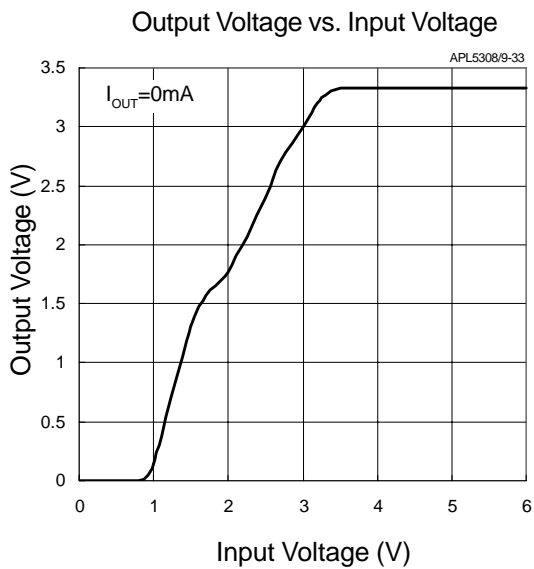
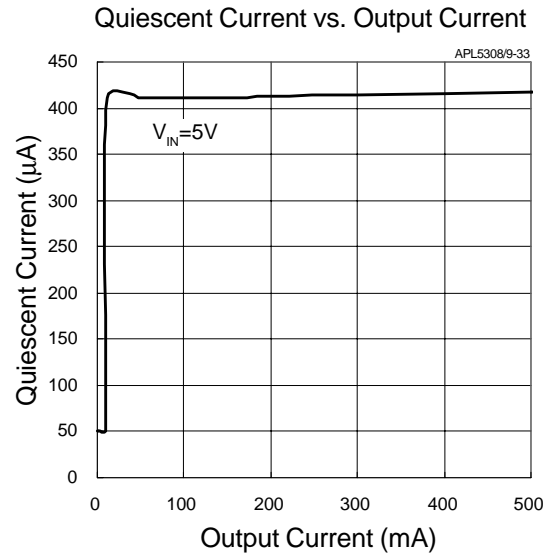
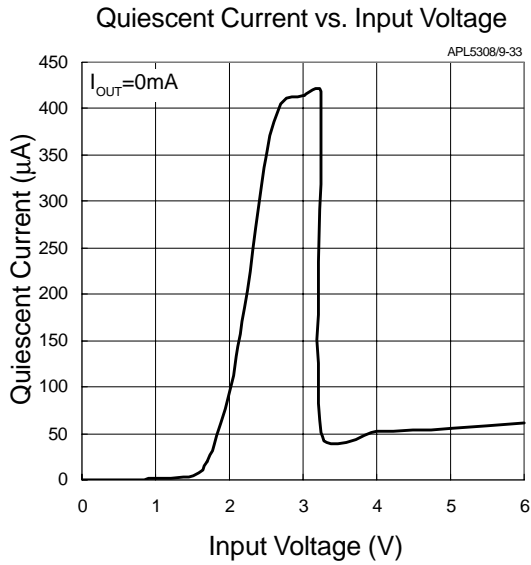

Typical Characteristics

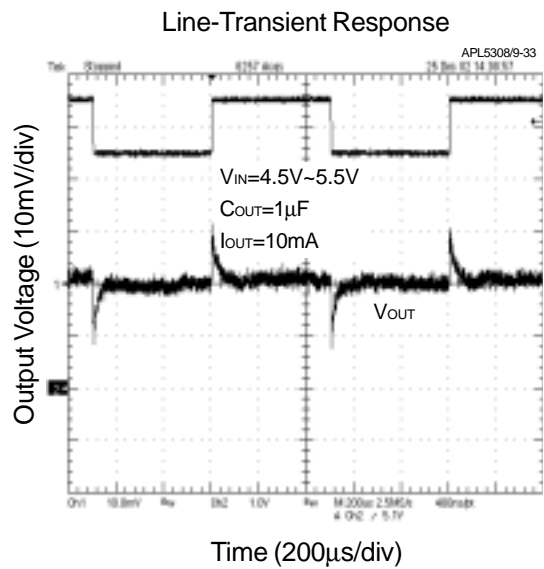
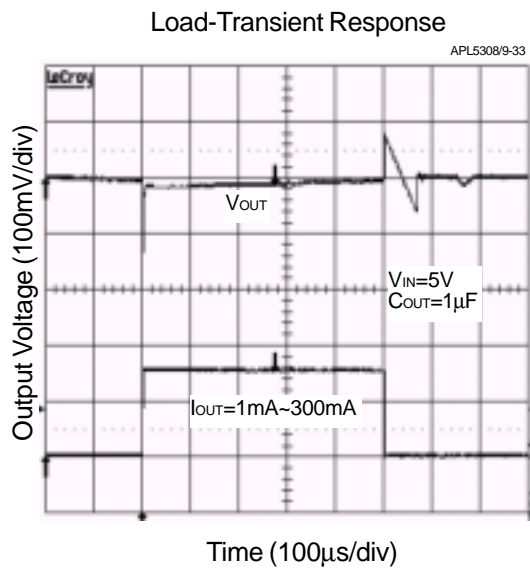
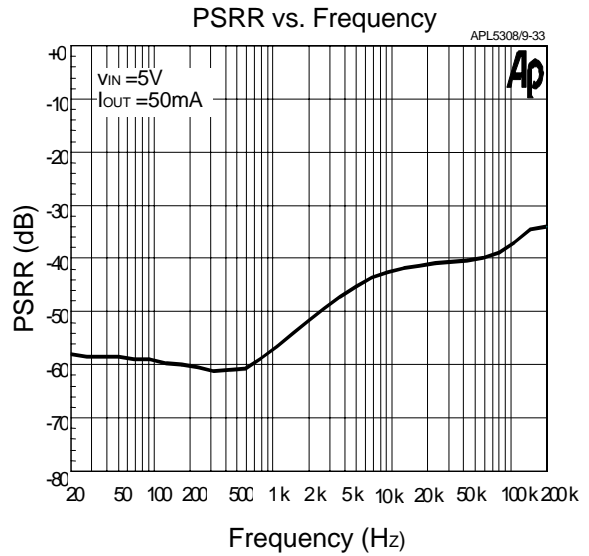
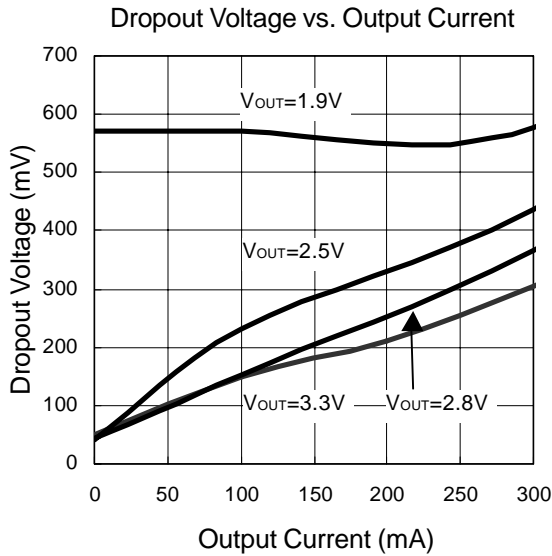

Typical Characteristics

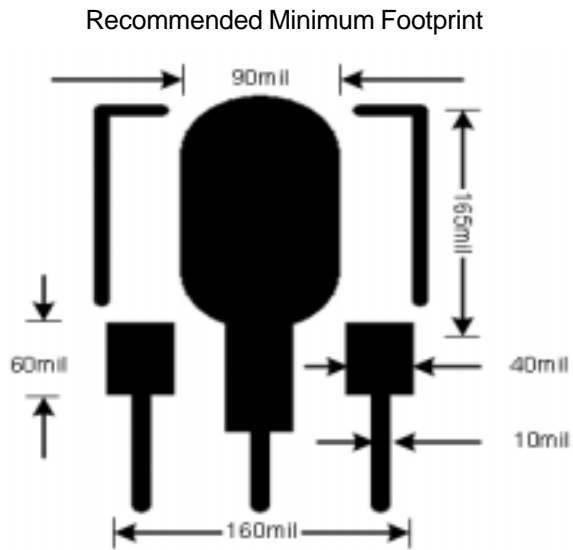

Packaging Information

SOT-23

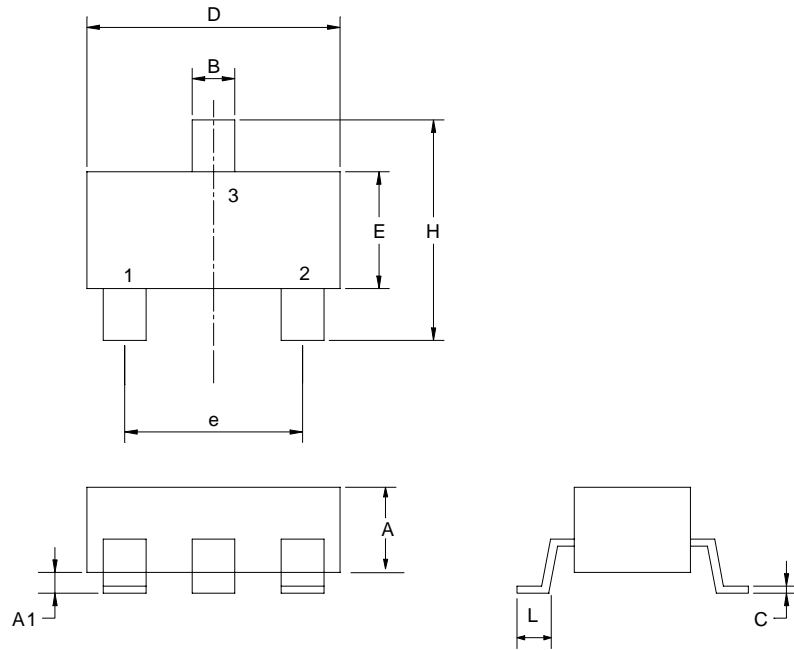

Dim	Millimeters		Inches	
	Min.	Max.	Min.	Max.
A	1.00	1.30	0.039	0.051
A1	0.00	0.10	0.000	0.004
B	0.35	0.51	0.014	0.020
C	0.10	0.25	0.004	0.010
D	2.70	3.10	0.106	0.122
E	1.40	1.80	0.055	0.071
e	1.90/2.1 BSC		0.075/0.083 BSC	
H	2.40	3.00	0.094	0.118
L	0.37		0.015	

Packaging Information

SOT-23-5

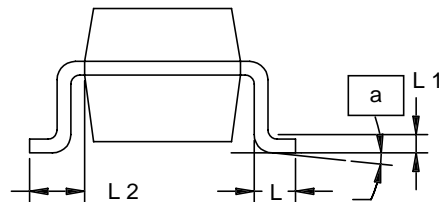
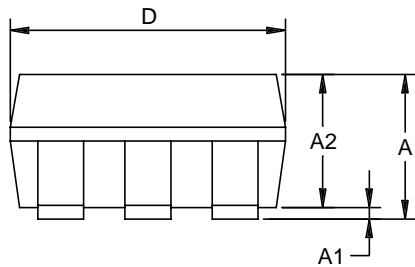
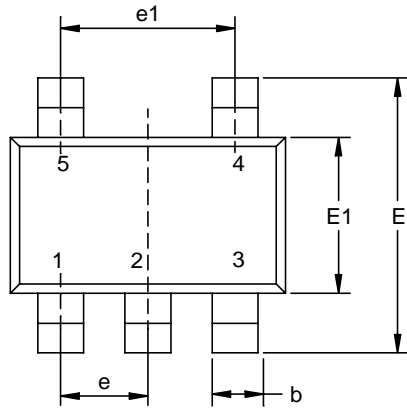

Dim	Millimeters		Inches	
	Min.	Max.	Min.	Max.
A	0.95	1.45	0.037	0.057
A1	0.05	0.15	0.002	0.006
A2	0.90	1.30	0.035	0.051
D	2.8	3.00	0.110	0.118
E	2.6	3.00	0.102	0.118
E1	1.5	1.70	0.059	0.067
L	0.35	0.55	0.014	0.022
L1	0.20 BSC		0.008 BSC	
L2	0.5	0.7	0.020	0.028
N	5		5	
α	0°	10°	0°	10°

Packaging Information

SOT-89 (Reference EIAJ ED-7500A Registration SC-62)

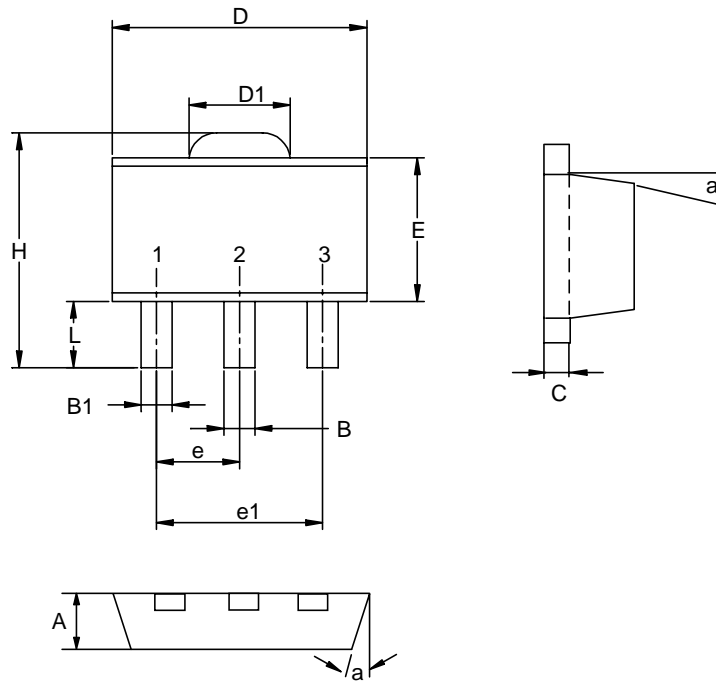

Dim	Millimeters		Inches	
	Min.	Max.	Min.	Max.
A	1.40	1.60	0.055	0.063
B	0.40	0.56	0.016	0.022
B1	0.35	0.48	0.014	0.019
C	0.35	0.44	0.014	0.017
D	4.40	4.60	0.173	0.181
D1	1.35	1.83	0.053	0.072
e	1.50 BSC		0.059 BSC	
e1	3.00 BSC		0.118 BSC	
E	2.29	2.60	0.090	0.102
H	3.75	4.25	0.148	0.167
L	0.80	1.20	0.031	0.047
α		10°		10°

Physical Specifications

Terminal Material	Solder-Plated Copper (Solder Material : 90/10 or 63/37 SnPb), 100%Sn
Lead Solderability	Meets EIA Specification RSI86-91, ANSI/J-STD-002 Category 3.

Reflow Condition (IR/Convection or VPR Reflow)

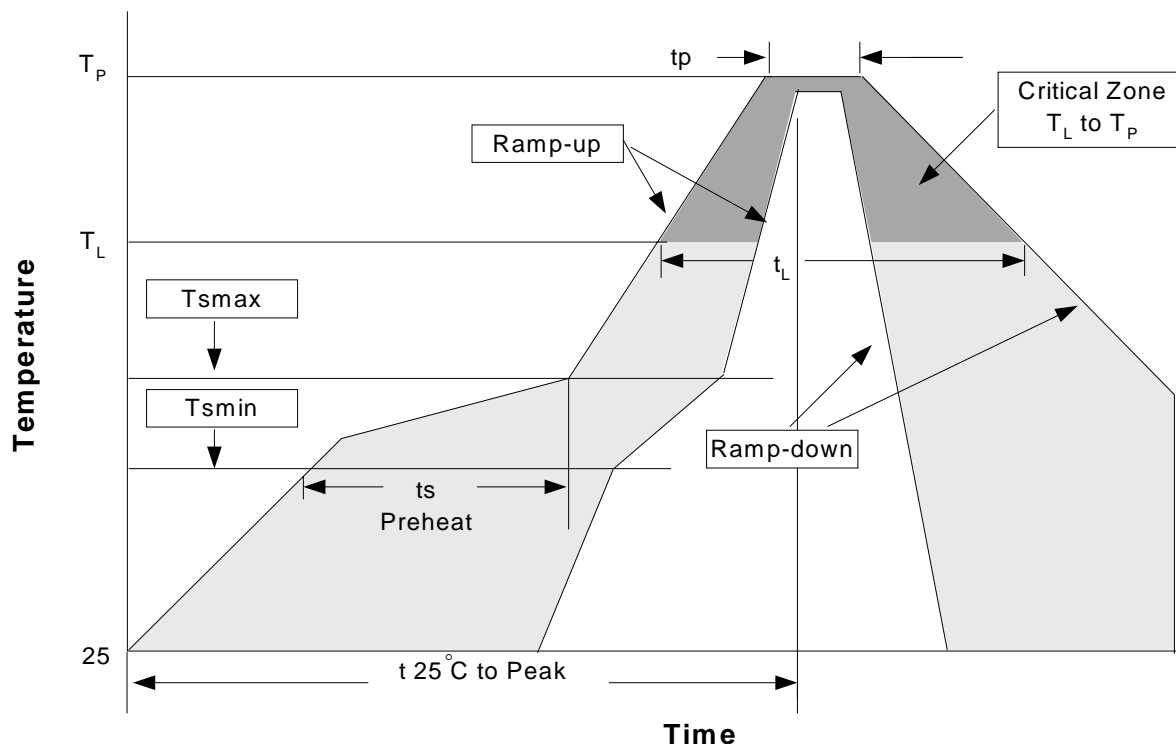

Classification Reflow Profiles

Profile Feature	Sn-Pb Eutectic Assembly		Pb-Free Assembly	
	Large Body	Small Body	Large Body	Small Body
Average ramp-up rate (T _L to T _P)	3°C/second max.		3°C/second max.	
Preheat				
- Temperature Min (T _{smin})	100°C		150°C	
- Temperature Mix (T _{smax})	150°C		200°C	
- Time (min to max)(t _s)	60-120 seconds		60-180 seconds	
T _{smax} to T _L				
- Ramp-up Rate			3°C/second max	
T _{smax} to T _L				
- Temperature(T _L)	183°C		217°C	
- Time (t _L)	60-150 seconds		60-150 seconds	
Peak Temperature(T _p)	225 +0/-5°C	240 +0/-5°C	245 +0/-5°C	250 +0/-5°C
Time within 5°C of actual Peak Temperature(t _p)	10-30 seconds	10-30 seconds	10-30 seconds	20-40 seconds
Ramp-down Rate	6°C/second max.		6°C/second max.	
Time 25°C to Peak Temperature	6 minutes max.		8 minutes max.	

Note: All temperatures refer to topside of the package. Measured on the body surface.

Reliability test program

Test item	Method	Description
SOLDERABILITY	MIL-STD-883D-2003	245°C , 5 SEC
HOLT	MIL-STD-883D-1005.7	1000 Hrs Bias @ 125 °C
PCT	JESD-22-B, A102	168 Hrs, 100 % RH , 121°C
TST	MIL-STD-883D-1011.9	-65°C ~ 150°C, 200 Cycles
ESD	MIL-STD-883D-3015.7	VHBM > 2KV, VMM > 200V
Latch-Up	JESD 78	10ms , I _{tr} > 100mA

Carrier Tape

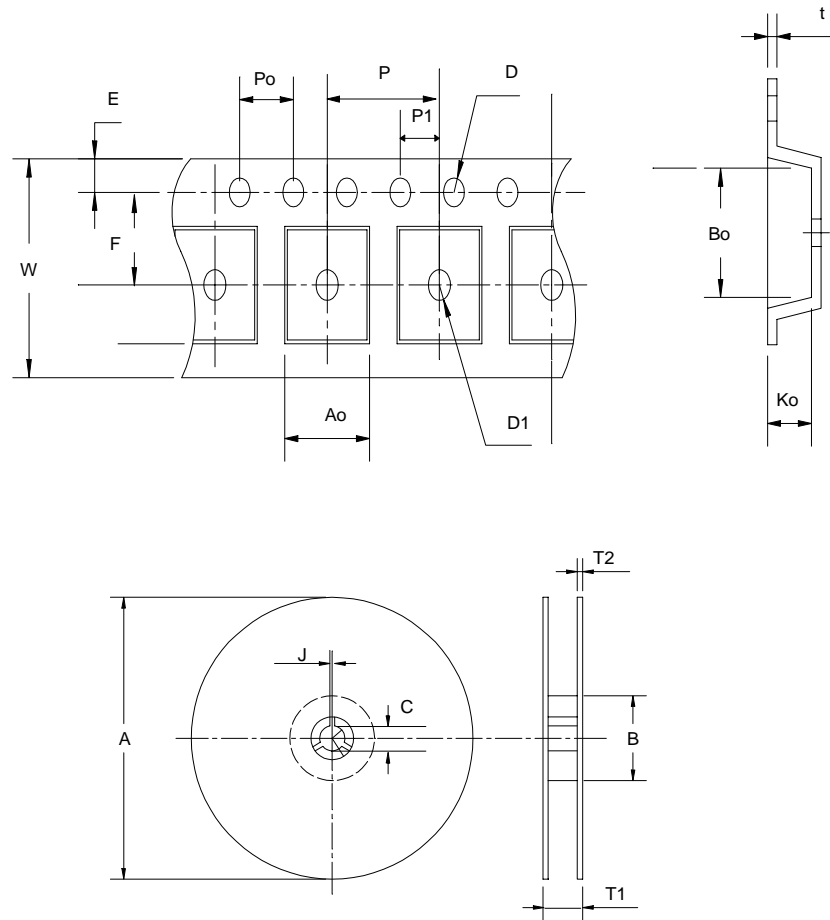

Carrier Tape

Application	A	B	C	J	T1	T2	W	P	E
SOT-23	178±1	60 ± 1.0	12.0	2.5 ± 0.15	9.0 ± 0.5	1.4	8.0 ^{+0.3} _{-0.3}	4.0	1.75
	F	D	D1	Po	P1	Ao	Bo	Ko	t
	3.5 ± 0.05	1.5 +0.1	φ 0.1MIN	4.0	2.0 ± 0.05	3.1	3.0	1.3	0.2±0.03
Application	A	B	C	J	T1	T2	W	P	E
SOT-23-5	178 ± 1	72 ± 1.0	13.0 + 0.2	2.5 ± 0.15	8.4 ± 2	1.5 ± 0.3	8.0 ± 0.3	4 ± 0.1	1.75± 0.1
	F	D	D1	Po	P1	Ao	Bo	Ko	t
	3.5 ± 0.05	1.5± 0.1	1.5± 0.1	4.0 ± 0.1	2.0 ± 0.1	3.15 ± 0.1	3.2± 0.1	1.4± 0.1	0.2±0.033
Application	A	B	C	J	T1	T2	W	P	E
SOT-89	178 ± 1	70 ± 2	13.5 ± 0.15	3 ± 0.15	14 ± 2	1.3 ± 0.3	12 ^{+0.3} _{12-0.1}	8 ± 0.1	1.75± 0.1
	F	D	D1	Po	P1	Ao	Bo	Ko	t
	5.5 ± 0.05	1.5± 0.1	1.5± 0.1	4.0 ± 0.1	2.0 ± 0.1	4.8 ± 0.1	4.5± 0.1	1.80± 0.1	0.3±0.013

(mm)

Cover Tape Dimensions

Application	Carrier Width	Cover Tape Width	Devices Per Reel
SOT- 23	8	5.3	3000
SOT- 23-5	8	5.3	3000
SOT- 89	12	9.3	1000

Customer Service

Anpec Electronics Corp.

Head Office :

5F, No. 2 Li-Hsin Road, SBIP,
Hsin-Chu, Taiwan, R.O.C.
Tel : 886-3-5642000
Fax : 886-3-5642050

Taipei Branch :

7F, No. 137, Lane 235, Pac Chiao Rd.,
Hsin Tien City, Taipei Hsien, Taiwan, R. O. C.
Tel : 886-2-89191368
Fax : 886-2-89191369