

# CR3AMZ

LOW POWER, STROBE USE  
NON-INSULATED TYPE, GLASS PASSIVATION TYPE

**CR3AMZ**



- $I_T (AV)$  ..... **0.4A**
- $V_{DRM}$  ..... **400V**
- $I_{GT}$  ..... **30mA**

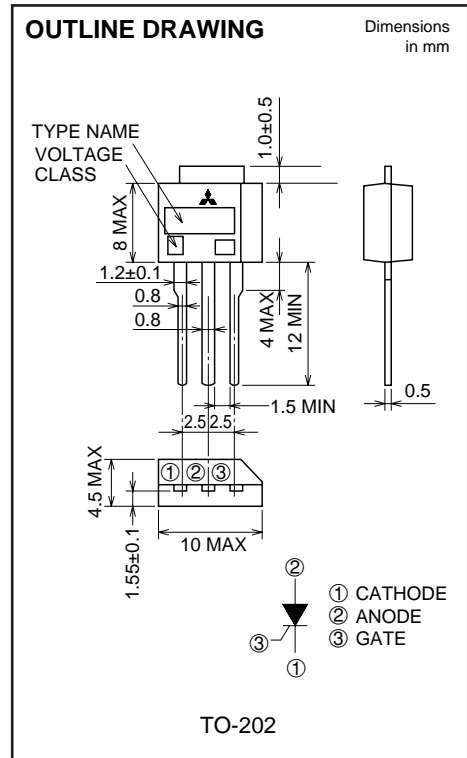

## APPLICATION

Automatic strobe flasher

## MAXIMUM RATINGS

Symbol	Parameter	Voltage class		Unit
		8		
VRRM	Repetitive peak reverse voltage	400		V
VRSM	Non-repetitive peak reverse voltage	480		V
VDRM	Repetitive peak off-state voltage	400		V
VDSM	Non-repetitive peak off-state voltage	480		V

Symbol	Parameter	Conditions	Ratings	Unit
$I_T (AV)$	Average on-state current	Commercial frequency, sine half wave, 180° conduction,	0.4	A
$I_{TRM}$	Repetitive peak on-state current *1	$C_M=700\mu F$ with discharge current	200	A
PGM	Peak gate power dissipation		0.5	W
PG (AV)	Average gate power dissipation		0.1	W
VFGM	Peak gate forward voltage		6	V
IFGM	Peak gate forward current		0.5	A
$T_j$	Junction temperature		-40 ~ +125	°C
$T_{stg}$	Storage temperature		-40 ~ +125	°C
—	Weight	Typical value	1.1	g

\*1. Refer to sections 1, 2 on STROBE FLASHER APPLICATION shown in the last sheet for CR3JM.

# CR3AMZ

LOW POWER, STROBE USE  
NON-INSULATED TYPE, GLASS PASSIVATION TYPE

## ELECTRICAL CHARACTERISTICS

Symbol	Parameter	Test conditions	Limits			Unit
			Min.	Typ.	Max.	
IRRM	Repetitive peak reverse current	$T_j=25^\circ\text{C}$ , $V_{RRM}$ applied	—	—	0.1	mA
IDRM	Repetitive peak off-state current	$T_j=25^\circ\text{C}$ , $V_{DRM}$ applied	—	—	0.1	mA
V <sub>TM</sub>	On-state voltage	$T_a=25^\circ\text{C}$ , $I_{TM}=3\text{A}$ , Instantaneous value	—	—	2.0	V
V <sub>GT</sub>	Gate trigger voltage	$T_j=25^\circ\text{C}$ , $V_D=6\text{V}$ , $R_L=6\Omega$	—	—	1.5	V
V <sub>GD</sub>	Gate non-trigger voltage	$T_j=125^\circ\text{C}$ , $V_D=1/2V_{DRM}$	0.1	—	—	V
I <sub>GT</sub>	Gate trigger current	$T_j=25^\circ\text{C}$ , $V_D=6\text{V}$ , $R_L=6\Omega$	—	—	30	mA
C <sub>c</sub>	Commutating capacitor *2	$C_M=700\mu\text{F}$ , $V_{CM}=350\text{V}$ , $I_{TM}=200\text{A}$ , $L=25\mu\text{H}$ , $T_a=25^\circ\text{C}$	—	—	2.2	$\mu\text{F}$

\*2. Refer to section 3 on STROBE FLASHER APPLICATION shown in the last sheet for CR3JM.

Fig 1. TEST CIRCUIT FOR COMMUTATING CAPACITOR

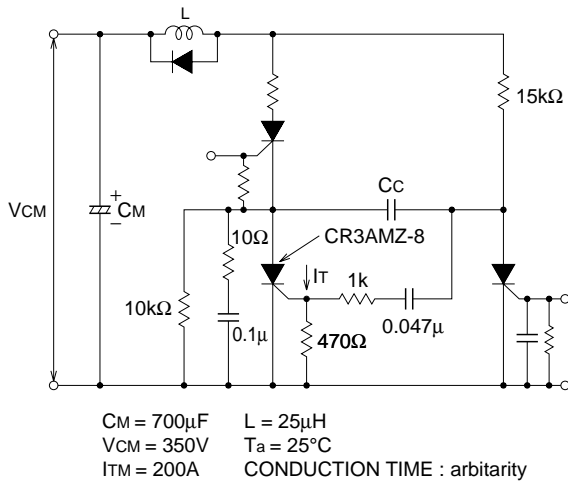

## PERFORMANCE CURVES

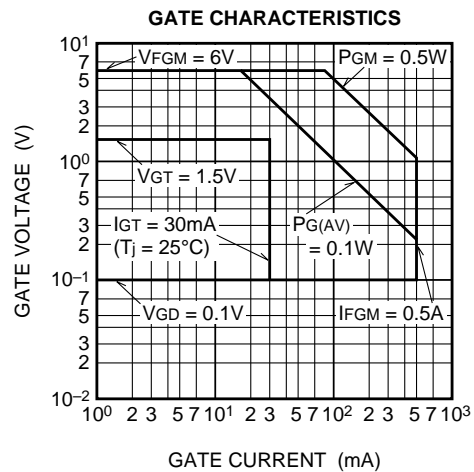
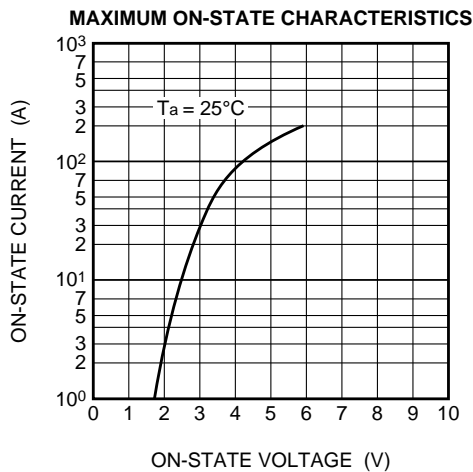

# CR3AMZ

LOW POWER, STROBE USE  
NON-INSULATED TYPE, GLASS PASSIVATION TYPE

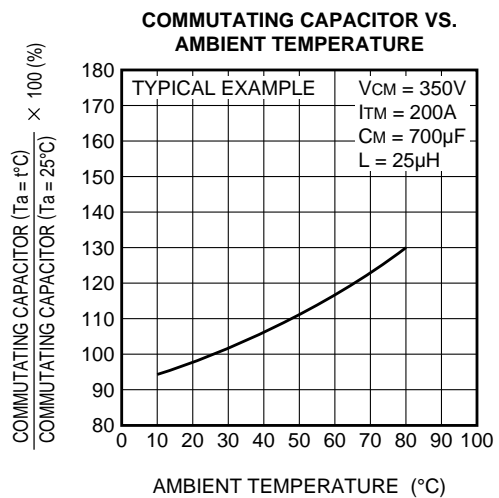
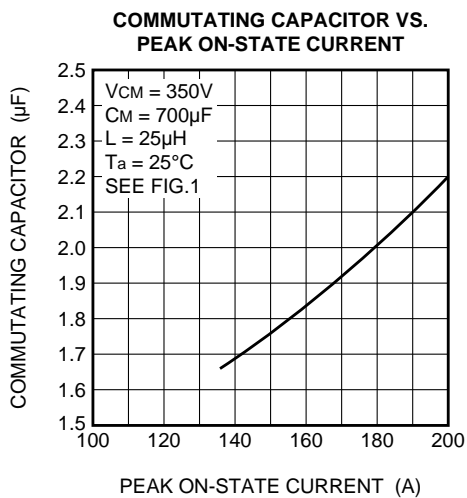
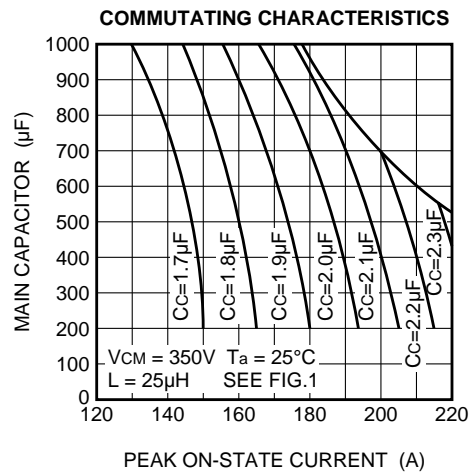
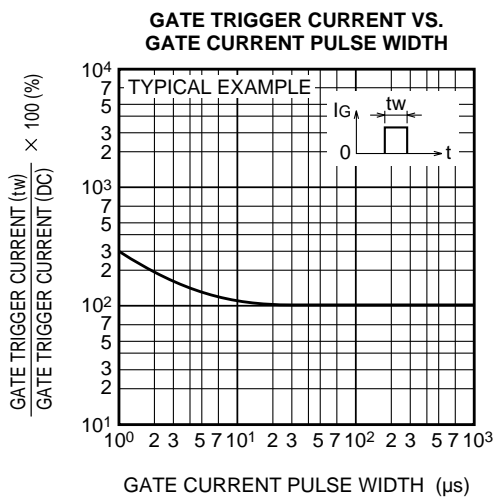
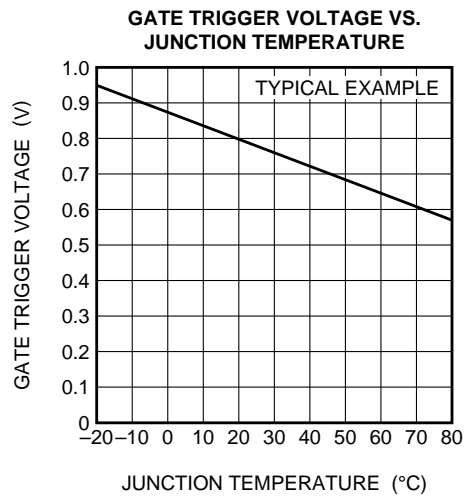
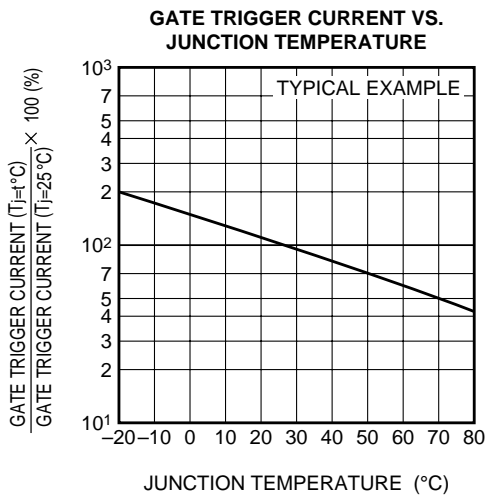

# CR3AMZ

LOW POWER, STROBE USE  
NON-INSULATED TYPE, GLASS PASSIVATION TYPE

**HOLDING CURRENT VS. JUNCTION TEMPERATURE**

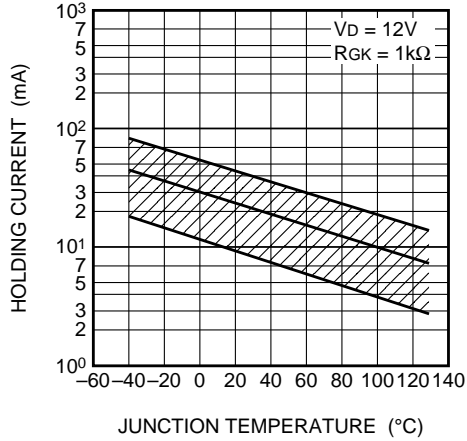

**BREAKOVER VOLTAGE VS. JUNCTION TEMPERATURE**

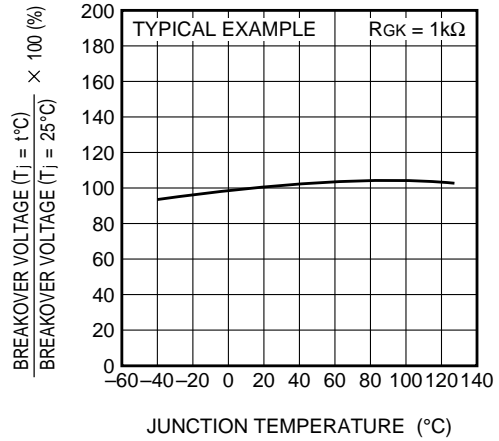

**PEAK OFF-STATE CURRENT VS. JUNCTION TEMPERATURE**

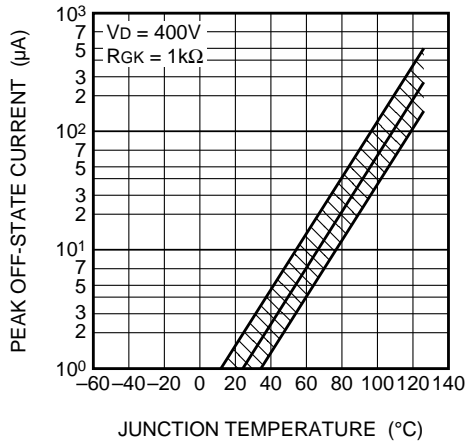

**PEAK REVERSE CURRENT VS. JUNCTION TEMPERATURE**

