

# HAL300 Differential Hall Effect Sensor IC

## Differential Hall Effect Sensor IC in CMOS technology

### Introduction

The HAL300 is a differential Hall switch produced in CMOS technology. The sensor includes 2 temperature-compensated Hall plates (2.05 mm apart) with active offset compensation, a differential amplifier with a Schmitt trigger, and an open-drain output transistor (see Fig. 2).

The HAL300 is a differential sensor which responds to spatial differences of the magnetic field. The Hall voltages at the two Hall plates,  $S_1$  and  $S_2$ , are amplified with a differential amplifier. The differential signal is compared with the actual switching level of the internal Schmitt trigger. Accordingly, the output transistor is switched on or off.

The sensor has a bipolar switching behavior and requires positive and negative values of  $\Delta B = B_{S1} - B_{S2}$  for correct operation.

The HAL 300 is an ideal sensor for applications with a rotating multi-pole-ring in front of the branded side of the package (see Fig. 4 and Fig. 5), such as ignition timing, anti-lock brake systems, and revolution counting.

For applications in which a magnet is mounted on the back side of the package (back-biased applications), the HAL320 is recommended.

The active offset compensation leads to constant magnetic characteristics over supply voltage and temperature.

The sensor is designed for industrial and automotive applications and operates with supply voltages from 4.5 V to 24 V in the ambient temperature range from  $-40\text{ }^\circ\text{C}$  up to  $150\text{ }^\circ\text{C}$ .

The HAL300 is available in a SMD-package (SOT-89A) and in a leaded version (TO-92UA).

### Features:

- distance between Hall plates: 2.05 mm
- operates from 4.5 V to 24 V supply voltage
- switching offset compensation at 62 kHz
- overvoltage protection
- reverse-voltage protection at  $V_{DD}$ -pin
- short-circuit protected open-drain output by thermal shutdown

- operates with magnetic fields from DC to 10 kHz
- output turns low with magnetic south pole on branded side of package and with a higher magnetic flux density in sensitive area  $S_1$  as in  $S_2$
- on-chip temperature compensation circuitry minimizes shifts of the magnetic parameters over temperature and supply voltage range
- the decrease of magnetic flux density caused by rising temperature in the sensor system is compensated by a built-in negative temperature coefficient of hysteresis
- EMC corresponding to DIN 40839

### Marking Code

Type	Temperature Range		
	A	E	C
HAL300SO, HAL300UA	300A	300E	300C

### Operating Junction Temperature Range ( $T_J$ )

**A:**  $T_J = -40\text{ }^\circ\text{C}$  to  $+170\text{ }^\circ\text{C}$

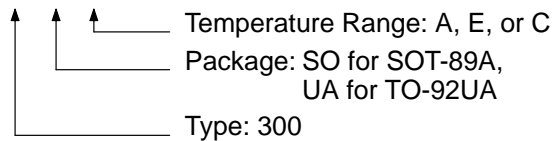
**E:**  $T_J = -40\text{ }^\circ\text{C}$  to  $+100\text{ }^\circ\text{C}$

**C:**  $T_J = 0\text{ }^\circ\text{C}$  to  $+100\text{ }^\circ\text{C}$

The relationship between ambient temperature ( $T_A$ ) and junction temperature ( $T_J$ ) is explained on page 11.

### Hall Sensor Package Codes

HALXXXPA-T



Example: **HAL300UA-E**

→ Type: 300

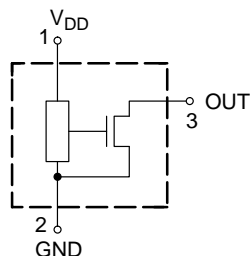
→ Package: TO-92UA

→ Temperature Range:  $T_J = -40\text{ }^\circ\text{C}$  to  $+100\text{ }^\circ\text{C}$

Hall sensors are available in a wide variety of packaging versions and quantities. For more detailed information, please refer to the brochure: "Ordering Codes for Hall Sensors".

## Solderability

- Package SOT-89A: according to IEC68-2-58
- Package TO-92UA: according to IEC68-2-20



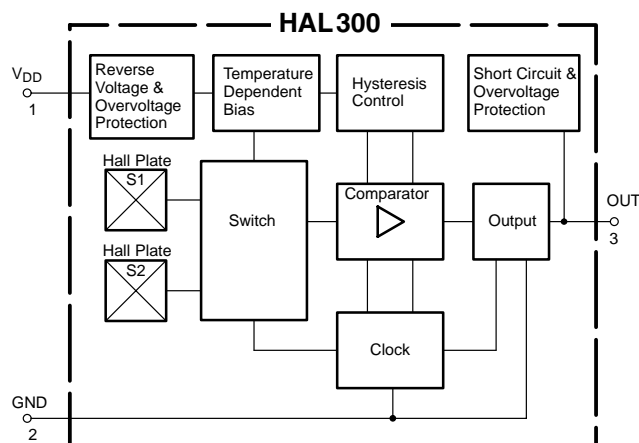
**Fig. 1:** Pin configuration

## Functional Description

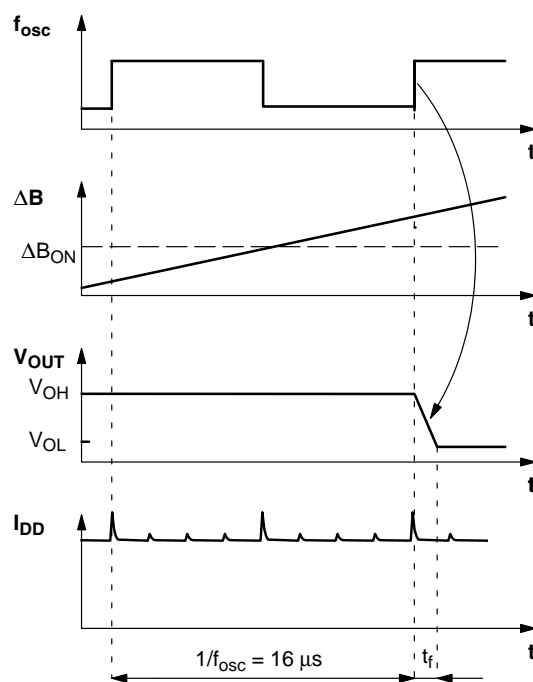
This Hall effect sensor is a monolithic integrated circuit with 2 Hall plates 2.05 mm apart that switches in response to differential magnetic fields. If magnetic fields with flux lines at right angles to the sensitive areas are applied to the sensor, the biased Hall plates force Hall voltages proportional to these fields. The difference of the Hall voltages is compared with the actual threshold level in the comparator. The temperature-dependent bias increases the supply voltage of the Hall plates and adjusts the switching points to the decreasing induction of magnets at higher temperatures. If the differential magnetic field exceeds the threshold levels, the open drain output switches to the appropriate state. The built-in hysteresis eliminates oscillation and provides switching behavior of the output without oscillation.

Magnetic offset caused by mechanical stress at the Hall plates is compensated for by using the “switching offset compensation technique”: An internal oscillator provides a two phase clock (see Fig. 3). The difference of the Hall voltages is sampled at the end of the first phase. At the end of the second phase, both sampled differential Hall voltages are averaged and compared with the actual switching point. Subsequently, the open drain output switches to the appropriate state. The amount of time that elapses from crossing the magnetic switch level to the actual switching of the output can vary between zero and  $1/f_{osc}$ .

Shunt protection devices clamp voltage peaks at the Output-Pin and  $V_{DD}$ -Pin together with external series resistors. Reverse current is limited at the  $V_{DD}$ -Pin by an internal series resistor up to  $-15$  V. No external reverse protection diode is needed at the  $V_{DD}$ -Pin for values ranging from 0 V to  $-15$  V.

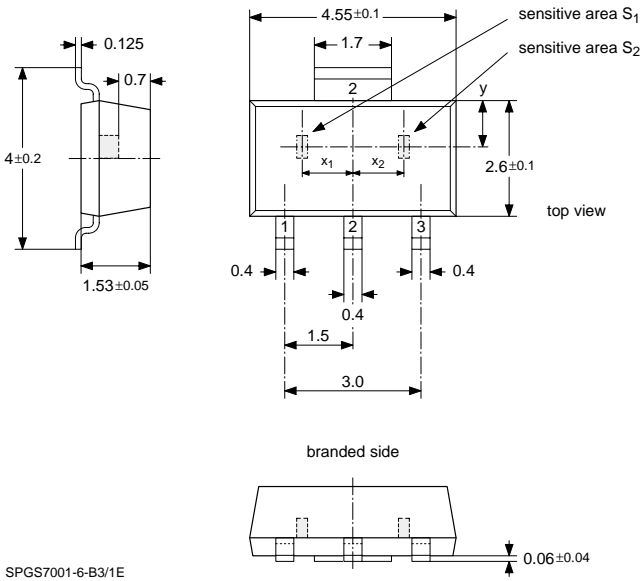


**Fig. 2:** HAL 300 block diagram

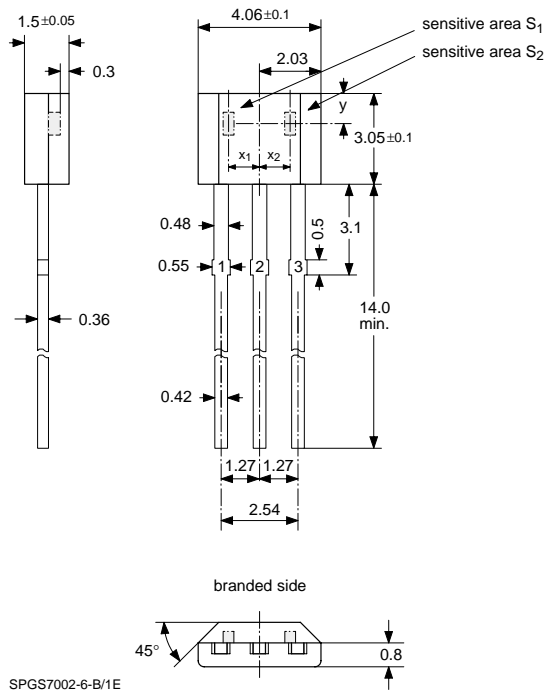


**Fig. 3:** Timing diagram

## Outline Dimensions



**Fig. 4:**  
 Plastic Small Outline Transistor Package  
**(SOT-89A)**  
 Weight approximately 0.04 g  
 Dimensions in mm



**Fig. 5:**  
 Plastic Transistor Single Outline Package  
**(TO-92UA)**  
 Weight approximately 0.12 g  
 Dimensions in mm

## Dimensions of Sensitive Areas

0.08 mm x 0.17 mm

## Positions of Sensitive Areas

SOT-89A	TO-92UA
$x_1 = -1.025 \text{ mm} \pm 0.2 \text{ mm}$	
$x_2 = 1.025 \text{ mm} \pm 0.2 \text{ mm}$	
$x_2 - x_1 = 2.05 \text{ mm} \pm 0.01 \text{ mm}$	
$y = 0.98 \text{ mm} \pm 0.2 \text{ mm}$	$y = 1.0 \text{ mm} \pm 0.2 \text{ mm}$

$x_1$  and  $x_2$  are referenced to the center of the package

**Absolute Maximum Ratings**

Symbol	Parameter	Pin No.	Min.	Max.	Unit
$V_{DD}$	Supply Voltage	1	-15	28 <sup>1)</sup>	V
$-V_P$	Test Voltage for Supply	1	-24 <sup>2)</sup>	-	V
$-I_{DD}$	Reverse Supply Current	1	-	50 <sup>1)</sup>	mA
$I_{DDZ}$	Supply Current through Protection Device	1	-200 <sup>3)</sup>	200 <sup>3)</sup>	mA
$V_O$	Output Voltage	3	-0.3	28 <sup>1)</sup>	V
$I_O$	Continuous Output On Current	3	-	30	mA
$I_{Omax}$	Peak Output On Current	3	-	250 <sup>3)</sup>	mA
$I_{OZ}$	Output Current through Protection Device	3	-200 <sup>3)</sup>	200 <sup>3)</sup>	mA
$T_S$	Storage Temperature Range		-65	150	°C
$T_J$	Junction Temperature Range		-40 -40	150 170 <sup>4)</sup>	°C

<sup>1)</sup> as long as  $T_{Jmax}$  is not exceeded  
<sup>2)</sup> with a 220  $\Omega$  series resistance at pin 1 corresponding to test circuit 1  
<sup>3)</sup>  $t < 2$  ms  
<sup>4)</sup>  $t < 1000$ h

Stresses beyond those listed in the “Absolute Maximum Ratings” may cause permanent damage to the device. This is a stress rating only. Functional operation of the device at these or any other conditions beyond those indicated in the “Recommended Operating Conditions/Characteristics” of this specification is not implied. Exposure to absolute maximum ratings conditions for extended periods may affect device reliability.

**Recommended Operating Conditions**

Symbol	Parameter	Pin No.	Min.	Max.	Unit
$V_{DD}$	Supply Voltage	1	4.5	24	V
$I_O$	Continuous Output On Current	3	-	20	mA
$V_O$	Output Voltage	3	-	24	V
$R_V$	Series Resistor	1	-	270	$\Omega$

**Electrical Characteristics** at  $T_J = -40\text{ °C}$  to  $+170\text{ °C}$ ,  $V_{DD} = 4.5\text{ V}$  to  $24\text{ V}$ , as not otherwise specified in Conditions  
 Typical Characteristics for  $T_J = 25\text{ °C}$  and  $V_{DD} = 12\text{ V}$

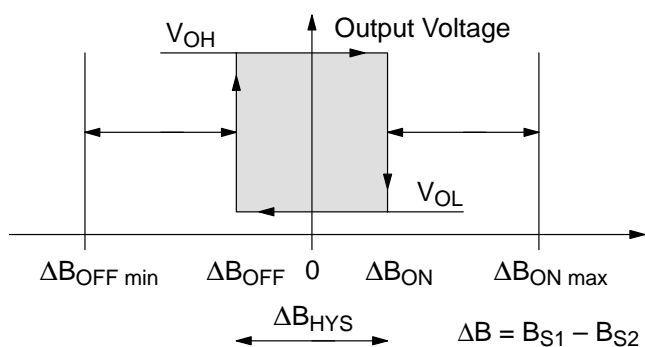
Symbol	Parameter	Pin No.	Min.	Typ.	Max.	Unit	Conditions
$I_{DD}$	Supply Current	1	4.0	5.5	6.8	mA	$T_J = 25\text{ °C}$
$I_{DD}$	Supply Current over Temperature Range	1	2.5	5	7.5	mA	
$V_{DDZ}$	Overvoltage Protection at Supply	1	–	28.5	32.5	V	$I_{DD} = 25\text{ mA}$ , $T_J = 25\text{ °C}$ , $t = 20\text{ ms}$
$V_{OZ}$	Overvoltage Protection at Output	3	–	28	32.5	V	$I_{OL} = 25\text{ mA}$ , $T_J = 25\text{ °C}$ , $t = 20\text{ ms}$
$V_{OL}$	Output Voltage	3	–	180	250	mV	$V_{DD} = 12\text{ V}$ , $I_O = 20\text{ mA}$ , $T_J = 25\text{ °C}$
$V_{OL}$	Output Voltage over Temperature Range	3	–	180	400	mV	$I_O = 20\text{ mA}$
$I_{OH}$	Output Leakage Current	3	–	0.06	1	$\mu\text{A}$	$V_{OH} = 4.5\text{ V} \dots 24\text{ V}$ , $\Delta B < \Delta B_{OFF}$ , $T_J = 25\text{ °C}$
$I_{OH}$	Output Leakage Current over Temperature Range	3	–	0.06	10	$\mu\text{A}$	$V_{OH} = 4.5\text{ V} \dots 24\text{ V}$ , $\Delta B < \Delta B_{OFF}$ , $T_J \leq 150\text{ °C}$
$f_{osc}$	Internal Oscillator Chopper Frequency	–	42	62	75	kHz	$T_J = 25\text{ °C}$
$f_{osc}$	Internal Oscillator Chopper Frequency over Temperature Range	–	36	62	78	kHz	
$t_{en(O)}$	Enable Time of Output after Setting of $V_{DD}$	3	–	35	–	$\mu\text{s}$	$V_{DD} = 12\text{ V}$ , $\Delta B > \Delta B_{ON} + 2\text{mT}$ or $\Delta B < \Delta B_{OFF} - 2\text{mT}$
$t_r$	Output Rise Time	3	–	80	400	ns	$V_{DD} = 12\text{ V}$ , $R_L = 820\ \Omega$ , $C_L = 20\text{ pF}$
$t_f$	Output Fall Time	3	–	45	400	ns	$V_{DD} = 12\text{ V}$ , $R_L = 820\ \Omega$ , $C_L = 20\text{ pF}$
$R_{thJSB}$ case SOT-89A	Thermal Resistance Junction to Substrate Backside		–	150	200	K/W	Fiberglass Substrate 30 mm x 10 mm x 1.5mm, pad size see Fig. 7
$R_{thJS}$ case TO-92UA	Thermal Resistance Junction to Soldering Point		–	150	200	K/W	

**Magnetic Characteristics** at  $T_J = -40\text{ }^\circ\text{C}$  to  $+170\text{ }^\circ\text{C}$ ,  $V_{DD} = 4.5\text{ V}$  to  $24\text{ V}$   
 Typical Characteristics for  $V_{DD} = 12\text{ V}$

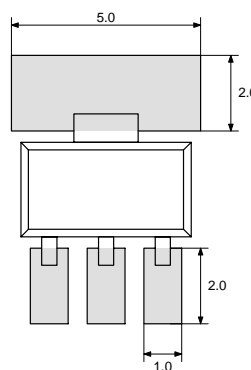
Magnetic flux density values of switching points (Condition:  $-10\text{ mT} < B_0 < 10\text{ mT}$ )

Positive flux density values refer to the magnetic south pole at the branded side of the package.  $\Delta B = B_{S1} - B_{S2}$

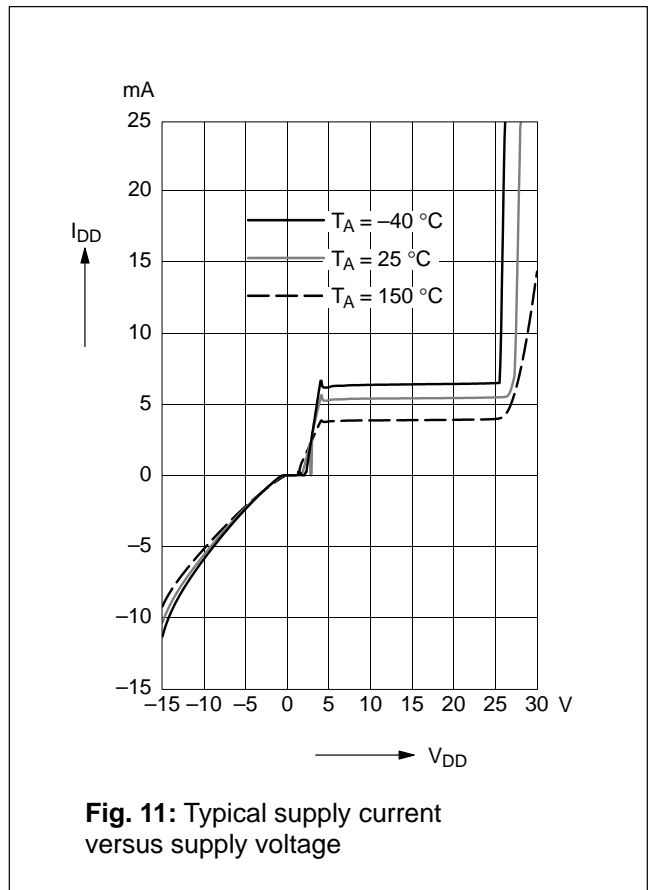
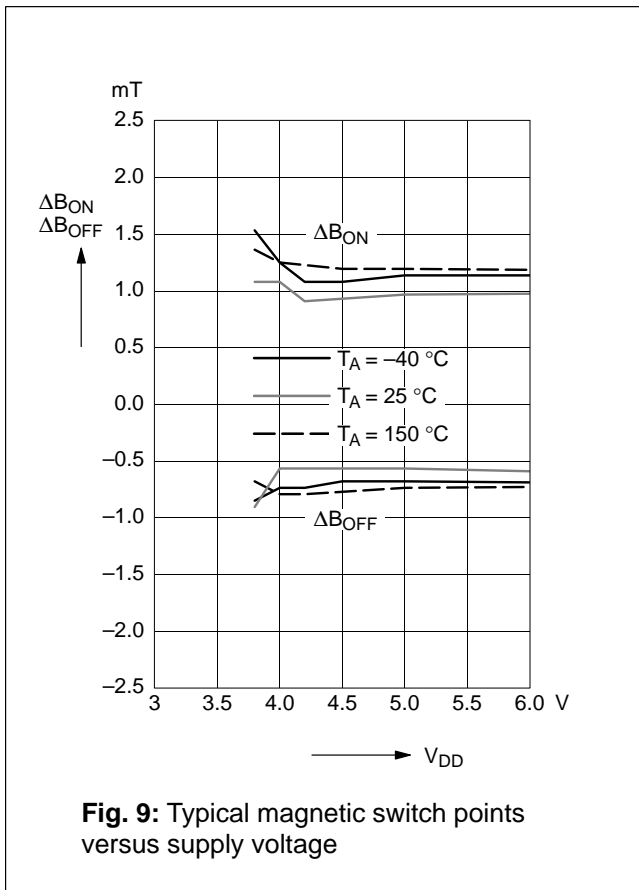
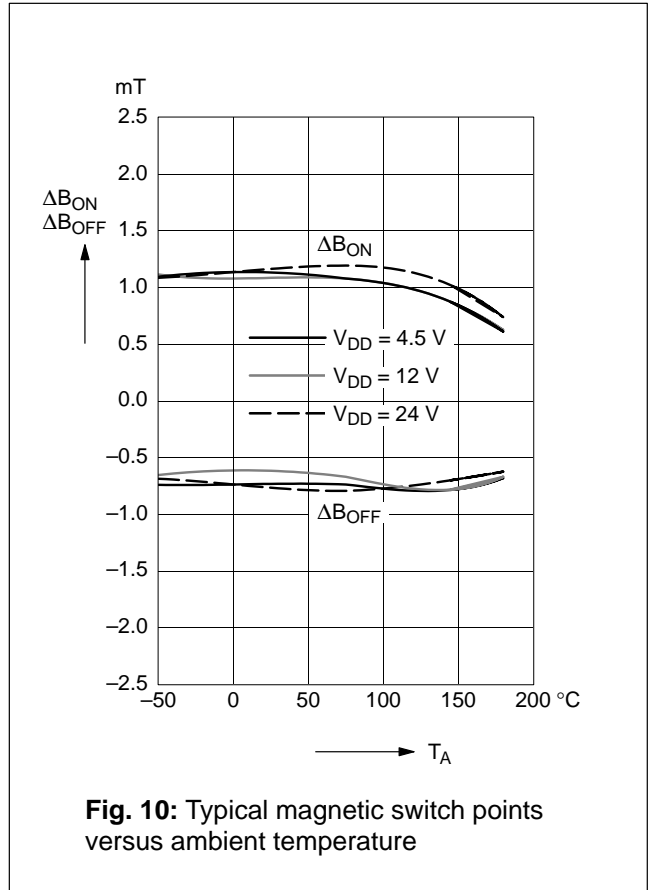
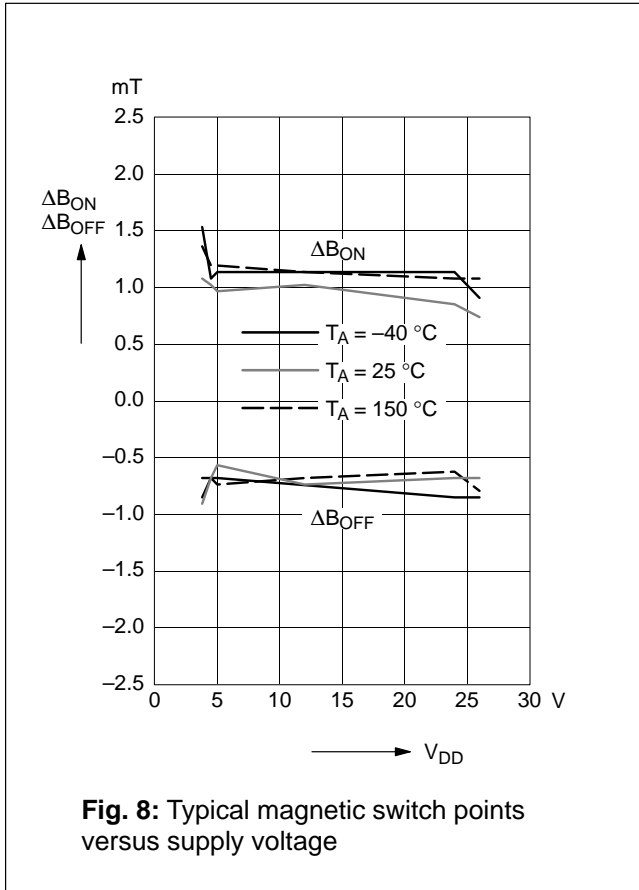
Parameter	-40 °C			25 °C			100 °C			170 °C			Unit
	Min.	Typ.	Max.	Min.	Typ.	Max.	Min.	Typ.	Max.	Min.	Typ.	Max.	
On point $\Delta B_{ON}$ $\Delta B > \Delta B_{ON}$	0.2	1.2	2.2	0	1.2	2.2	-0.5	1.0	2.5	-2.0	0.5	3.0	mT
Off point $\Delta B_{OFF}$ $\Delta B < \Delta B_{OFF}$	-2.2	-1.0	-0.2	-2.2	-1.0	0	-2.5	-1.1	0.5	-3.0	-1.2	2.0	mT
Hysteresis $\Delta B_{HYS} = \Delta B_{ON} - \Delta B_{OFF}$	1.2	2.2	3.0	1.2	2.2	3.0	1.0	2.1	3.0	0.8	1.7	3.0	mT
Offset $\Delta B_{OFFSET} = (\Delta B_{ON} + \Delta B_{OFF})/2$	-1.1	0.1	1.1	-1.1	0.1	1.1	-1.5	-0.1	1.5	-2.5	-0.5	2.5	mT



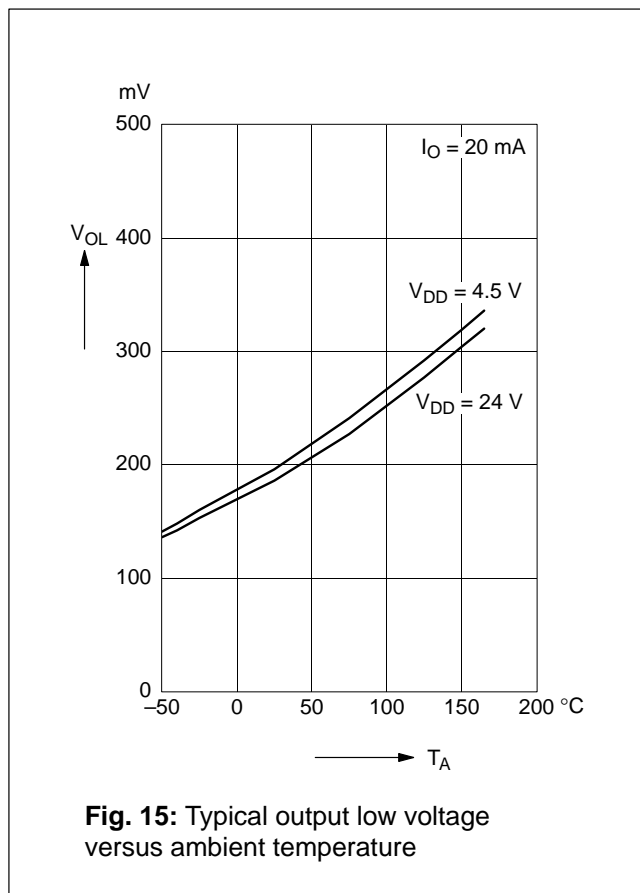
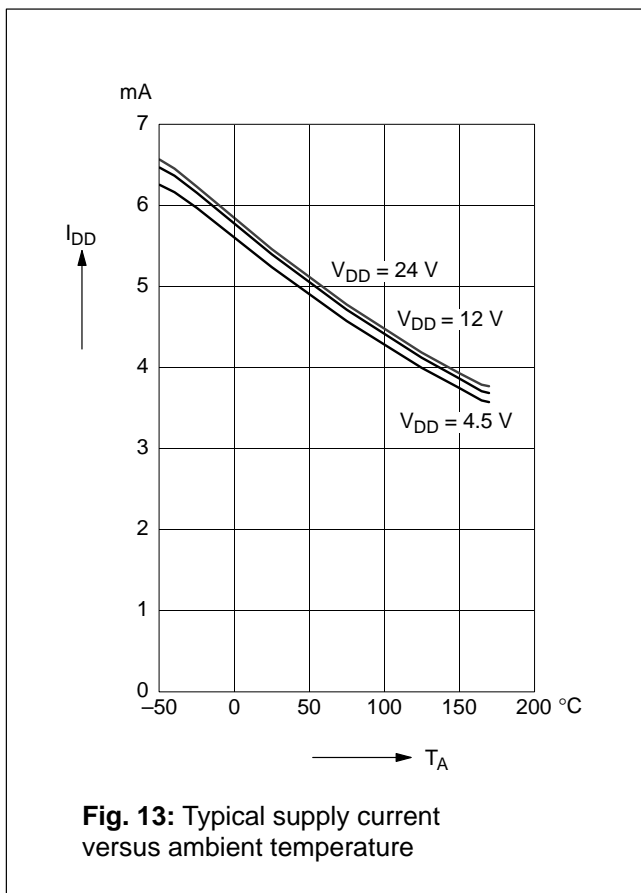
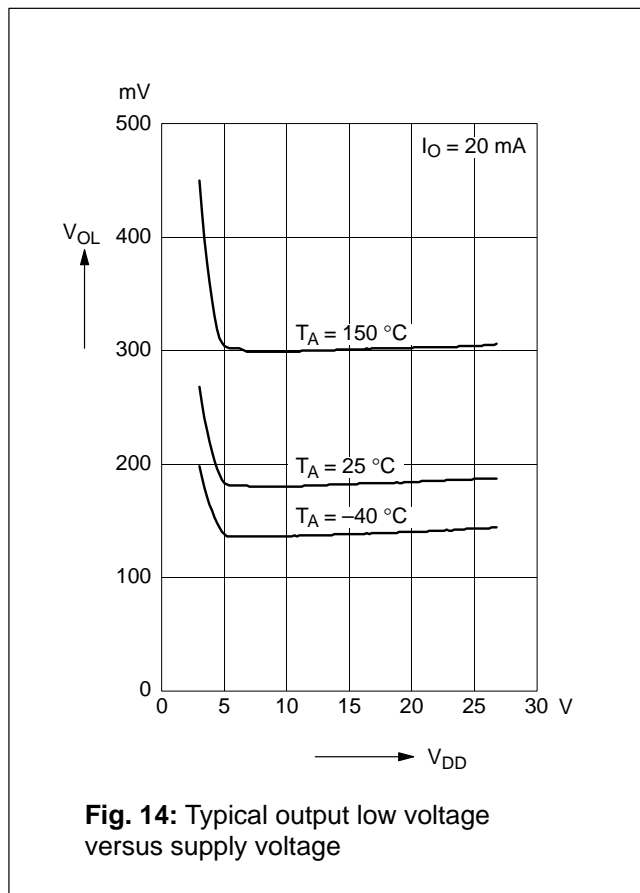
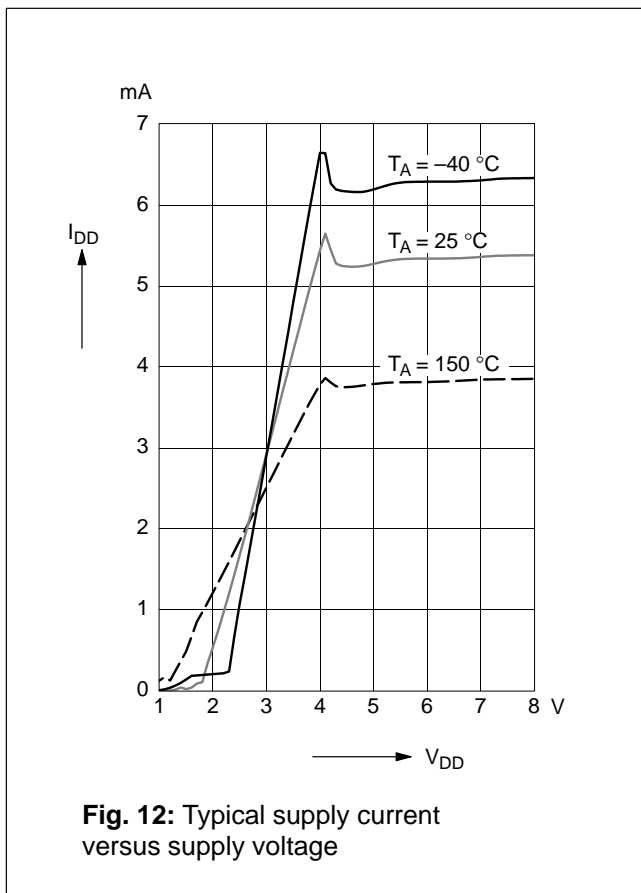
**Fig. 6:** Definition of switching points and hysteresis

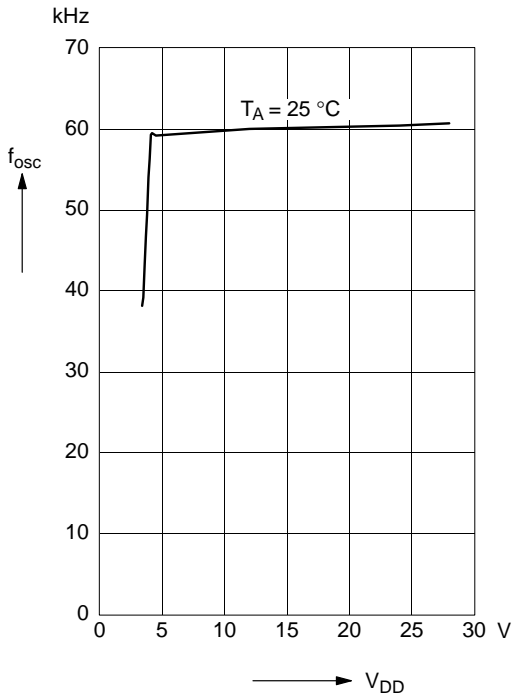


**Fig. 7:** Recommended pad size SOT-89A  
 Dimensions in mm

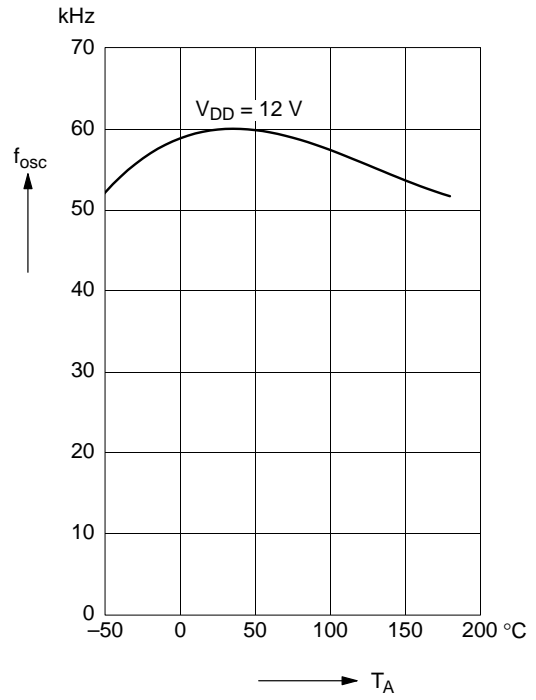




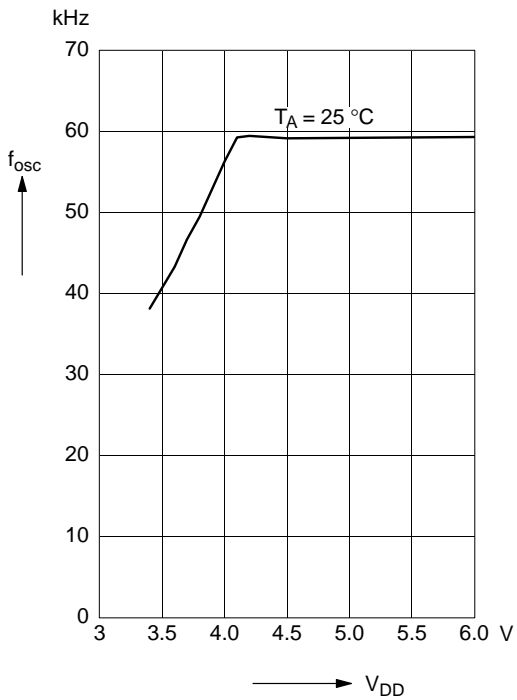




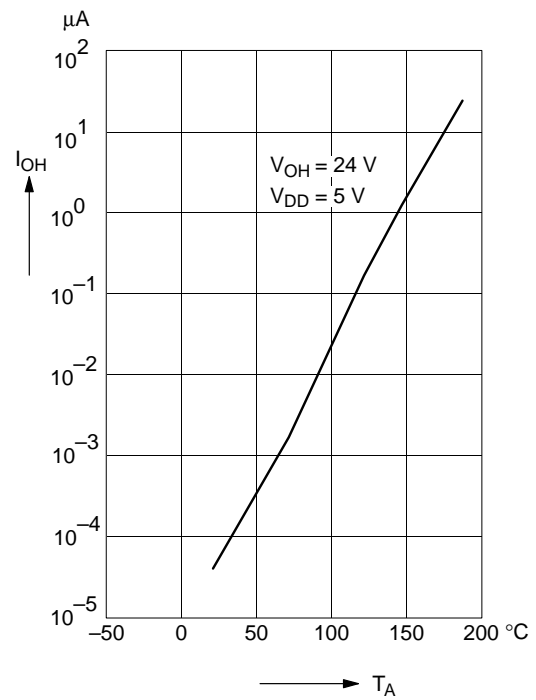
**Fig. 16:** Typical internal chopper frequency versus supply voltage



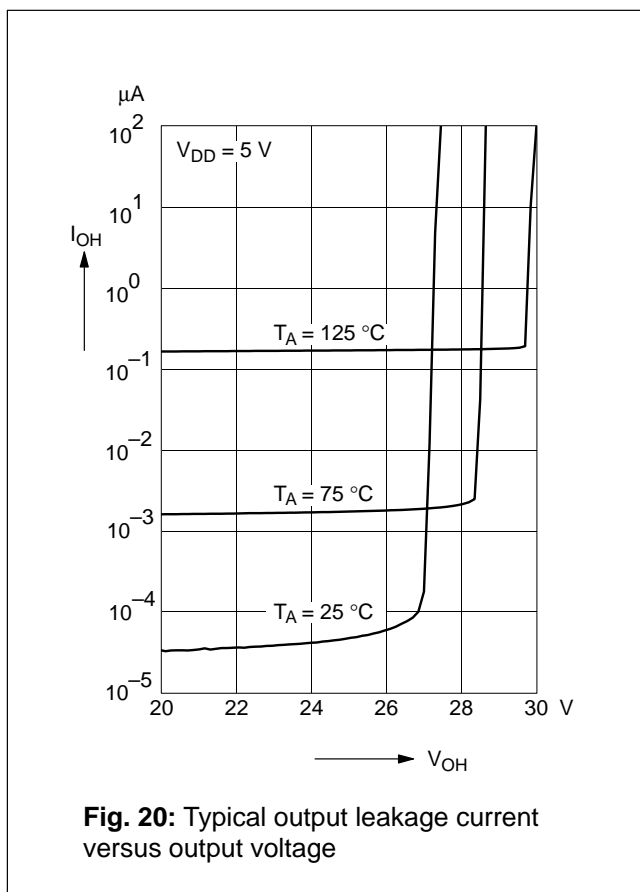
**Fig. 18:** Typical internal chopper frequency versus ambient temperature



**Fig. 17:** Typical internal chopper frequency versus supply voltage



**Fig. 19:** Typical output leakage current versus ambient temperature



## Application Notes

Mechanical stress can change the sensitivity of the Hall plates and an offset of the magnetic switching points may result. External mechanical stress to the package can influence the magnetic parameters if the sensor is used under back-biased applications. This piezo sensitivity of the sensor IC cannot be completely compensated for by the switching offset compensation technique.

For back-biased applications, the HAL320 is recommended. In such cases, please contact our Application Department. They will provide assistance in avoiding applications which may induce stress to the ICs. This stress may cause drifts of the magnetic parameters indicated in this data sheet.

For electromagnetic immunity, it is recommended to apply a 4.7 nF capacitor between V<sub>DD</sub> (pin 1) and Ground (pin 2). For automotive applications, a 220 Ω series resistor to pin 1 is recommended. Because of the I<sub>DD</sub> peak at 4.1 V, the series resistor should not be greater than 270 Ω. The series resistor and the capacitor should be placed as close as possible to the IC.

## Ambient Temperature

Due to the internal power dissipation, the temperature on the silicon chip (junction temperature T<sub>J</sub>) is higher than the temperature outside the package (ambient temperature T<sub>A</sub>).

$$T_J = T_A + \Delta T$$

At static conditions, the following equations are valid:

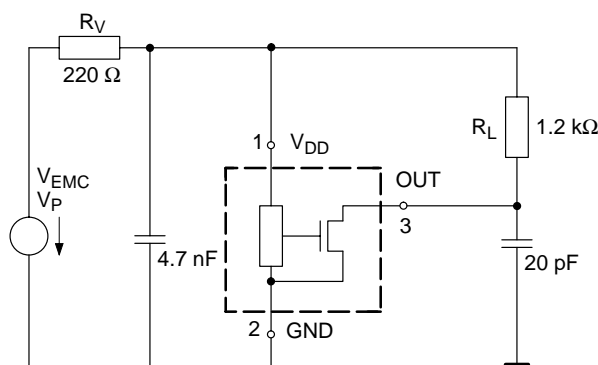
– for SOT-89A:  $\Delta T = I_{DD} * V_{DD} * R_{thJSB}$

– for TO-92UA:  $\Delta T = I_{DD} * V_{DD} * R_{thJA}$

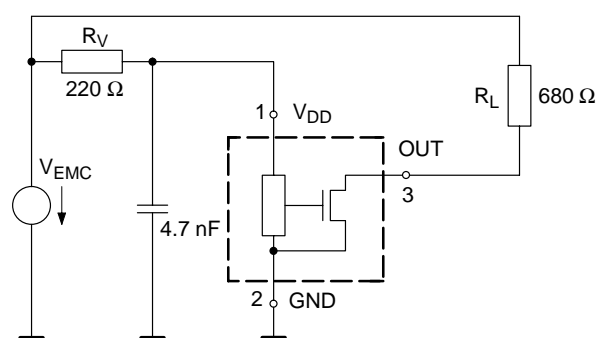
For typical values, use the typical parameters. For worst case calculation, use the max. parameters for I<sub>DD</sub> and R<sub>th</sub>, and the max. value for V<sub>DD</sub> from the application.

## Test Circuits for Electromagnetic Compatibility

Test pulses V<sub>EMC</sub> corresponding to DIN 40839.



**Fig. 21:** Test circuit 2: test procedure for class A



**Fig. 22:** Test circuit 1: test procedure for class C

## Interferences conducted along supply lines in 12 V onboard systems

Product standard: DIN 40839 part 1

Pulse	Level	$U_s$ in V	Test circuit	Pulses/Time	Function Class	Remarks
1	IV	-100	1	5000	C	5 s pulse interval
2	IV	100	1	5000	C	0.5 s pulse interval
3a	IV	-150	2	1 h	A	
3b	IV	100	2	1h	A	
4	IV	-7	2	5	A	
5	IV	86.5	1	10	C	10 s pulse interval

## Electrical transient transmission by capacitive and inductive coupling via lines other than the supply lines

Product standard: DIN 40839 part 3

Pulse	Level	$U_s$ in V	Test circuit	Pulses/Time	Function Class	Remarks
1	IV	-30	2	500	A	5 s pulse interval
2	IV	30	2	500	A	0.5 s pulse interval
3a	IV	-60	2	10 min	A	
3b	IV	40	2	10 min	A	

## Radiated Disturbances

Product standard: DIN 40839 part 4

### Test Conditions

- Temperature: Room temperature (22...25 °C)
- Supply voltage: 13 V
- Lab equipment: TEM cell 220 MHz (VW standard)  
with adaptor board 455 mm, device 80 mm over ground
- Frequency range: 5...220 MHz; 1 MHz steps
- Test circuit 2 with  $R_L = 1.2 \text{ k}\Omega$

### Tested Devices and Results

Type	Field strength	Modulation	Result
HAL300	> 200 V/m	1 kHz 80 %	output voltage stable on the level high or low <sup>1)</sup>
1) low level < 0.4 V, high level > 90% of $V_{DD}$			







## Data Sheet History

1. Final data sheet: "HAL300 Differential Hall Effect Sensor IC", July 15, 1998, 6251-345-1DS. First release of the final data sheet.

Micronas GmbH  
Hans-Bunte-Strasse 19  
D-79108 Freiburg (Germany)  
P.O. Box 840  
D-79008 Freiburg (Germany)  
Tel. +49-761-517-0  
Fax +49-761-517-2174  
E-mail: [docservice@micronas.com](mailto:docservice@micronas.com)  
Internet: [www.micronas.com](http://www.micronas.com)

Printed in Germany  
by Systemdruck+Verlags-GmbH, Freiburg (07/1998)  
Order No. 6251-345-1DS

All information and data contained in this data sheet are without any commitment, are not to be considered as an offer for conclusion of a contract, nor shall they be construed as to create any liability. Any new issue of this data sheet invalidates previous issues. Product availability and delivery are exclusively subject to our respective order confirmation form; the same applies to orders based on development samples delivered. By this publication, Micronas GmbH does not assume responsibility for patent infringements or other rights of third parties which may result from its use.

Further, Micronas GmbH reserves the right to revise this publication and to make changes to its content, at any time, without obligation to notify any person or entity of such revisions or changes.

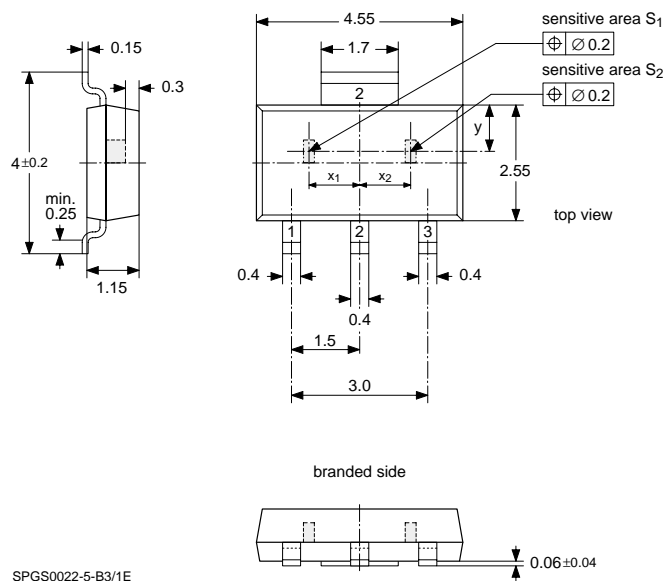
No part of this publication may be reproduced, photocopied, stored on a retrieval system, or transmitted without the express written consent of Micronas GmbH.



<b>Subject:</b>	Improvement of SOT-89B Package
<b>Data Sheet Concerned:</b>	HAL 300, 6251-345-1DS, Edition July 15, 1998 HAL 320, 6251-439-1DS, Edition July 15, 1998
<b>Supplement:</b>	No. 1/ 6251-532-1DSS
<b>Edition:</b>	July 4, 2000

**Changes:**

- position tolerance of the sensitive area reduced
- tolerances of the outline dimensions reduced
- thickness of the leadframe changed to 0.15 mm (old 0.125 mm)
- HAL 300 now available in SOT-89B
- SOT-89A will be discontinued in December 2000



**Position of sensitive area**

	HAL 300	HAL 320
x <sub>1</sub> +x <sub>2</sub>	(2.05±0.001) mm	(2.25±0.001) mm
x <sub>1</sub> = x <sub>2</sub>	1.025 mm nominal	1.125 mm nominal
y	0.95 mm nominal	0.95 mm nominal

**Note:** A mechanical tolerance of ±0.05 mm applies to all dimensions where no tolerance is explicitly given. Position tolerances of the sensitive areas are defined in the package diagram.