

SURFACE MOUNT RESIN MOLDED TANTALUM CHIP CAPACITORS
HIGH RELIABILITY

NEC's SV/H series solid tantalum capacitor has developed for automotive application.

Comparing to the former type (R Series), the higher reliability and the higher performance have been built in the same chip size with the NEC's original technologies.

FEATURES

The SV/H series has the highest level of reliability and performance in the tantalum chip capacitors as shown below.

- Damp heat (steady state) : 85°C, 85% RH 1000 hours
- Rapid change of temperature: -55°C to +125°C, 1000 cycles
- Resistance to soldering : 260°C, 10 sec (Fully immersed to solder)
- Failure rate : 0.5%/1000 hours (at 85°C, rated voltage applied)

APPLICATIONS

- Automotive electronics
- Other electronic equipment which requires high reliability and performance.

DIMENSIONS

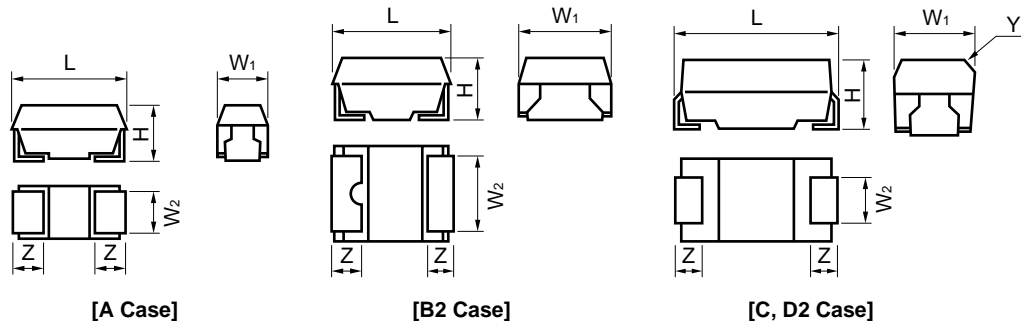

(Unit: mm)

Case Code	L	W ₁	W ₂	H	Z	Y
A	3.2 ± 0.2	1.6 ± 0.2	1.2 ± 0.1	1.6 ± 0.2	0.8 ± 0.3	-
B2	3.5 ± 0.2	2.8 ± 0.2	2.3 ± 0.1	1.9 ± 0.2	0.8 ± 0.3	-
C	6.0 ± 0.3	3.2 ± 0.3	1.8 ± 0.1	2.5 ± 0.3	1.3 ± 0.3	0.4C
D2	5.8 ± 0.3	4.6 ± 0.3	2.4 ± 0.1	3.2 ± 0.3	1.3 ± 0.3	-

The information in this document is subject to change without notice.

MARKING

- Upper face -

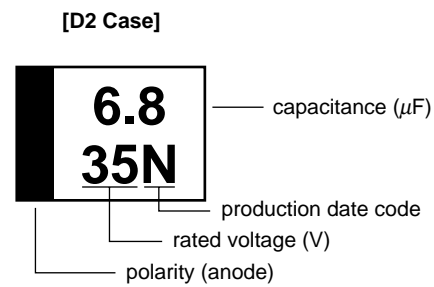
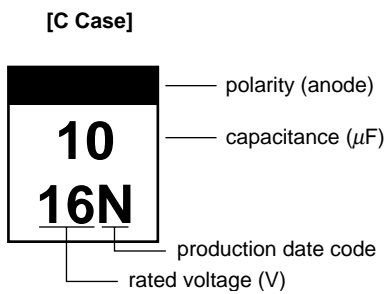
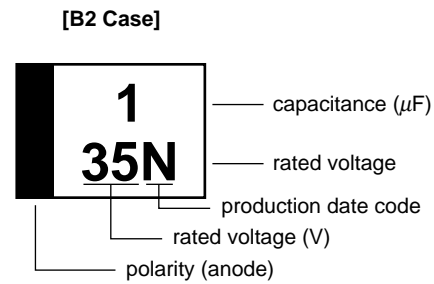
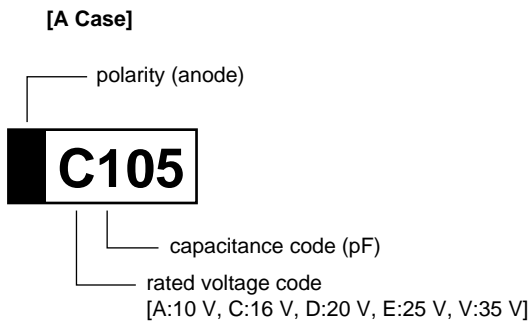

- Bottom face -
(for A case sizes)

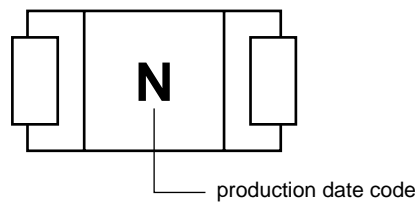

[Marking of production date code]

Y \ M	Jan.	Feb.	Mar.	Apr.	May	Jun.	Jul.	Aug.	Sept.	Oct.	Nov.	Dec.
1995	a	b	c	d	e	f	g	h	j	k	l	m
1996	n	p	q	r	s	t	u	v	w	x	y	z
1997	A	B	C	D	E	F	G	H	J	K	L	M
1998	N	P	Q	R	S	T	U	V	W	X	Y	Z

Data code will resume beginning in 1999.

PRODUCT LINE UP AND CASE CODE

Capacitance (μF)	U_R (Vdc)				
	10 V	16 V	20 V	25 V	35 V
0.1					A
0.15					A
0.22					A
0.33					A
0.47				A	B2
0.68			A		B2
1		A			B2
1.5		A		B2	C
2.2	A		B2		C
3.3		B2			C
4.7	B2			C	D2
6.8			C		D2
10		C		D2	
15	C		D2		
22		D2			
33	D2				

U_R : Rated voltage

PART NUMBER SYSTEM

- Bulk -

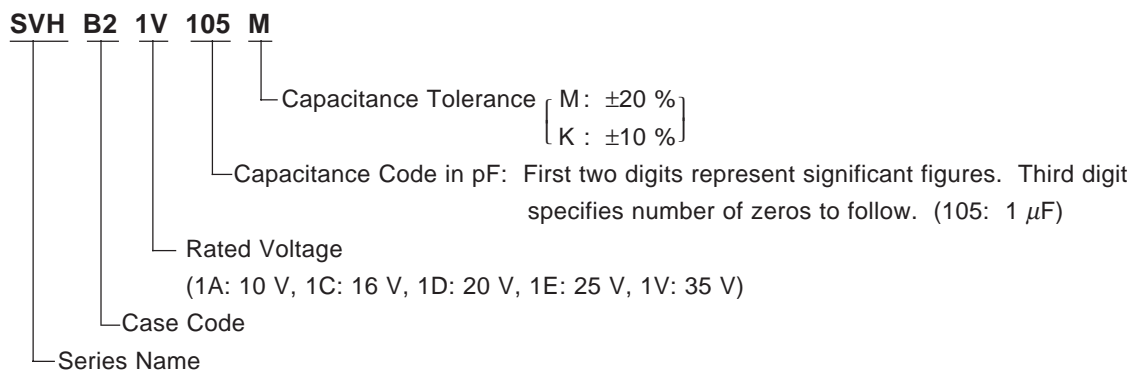

- Tape and Reel -

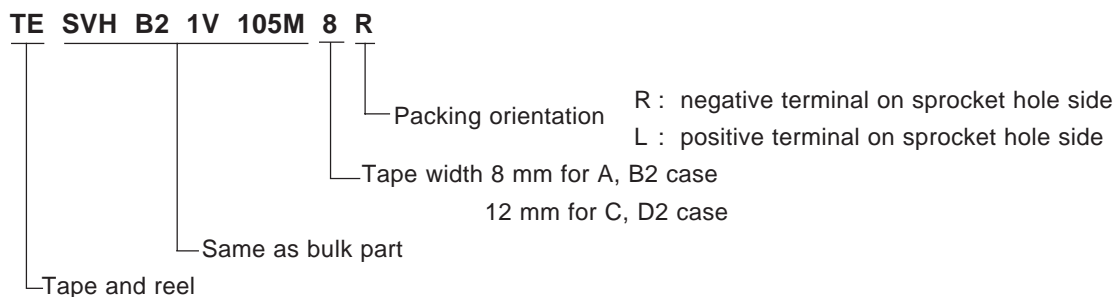

PERFORMANCE

No.	Items	Specifications						Test Conditions
1	Operating Temp. Range	-55 to +125°C						Applied voltage shall be derated over +85°C
2	Rated Voltage	10	16	20	25	35	Vdc	
3	Surge Voltage	13	20	26	33	46	Vdc	at 85°C
4	Derated Voltage	6.3	10	13	16	22	Vdc	at 125°C
5	Capacitance Range	0.1 to 33 μ F						
6	Capacitance Tolerance	\pm 20%, \pm 10%						at 120 Hz
7	Leakage Current	0.01CV (μ A) or 0.5 (μ A) whichever is greater						Rated Voltage applied after 5 minutes.
8	Tangent of loss angle	0.1 to 4.7 μ F: 0.04 MAX. 6.8 to 33 μ F : 0.06 MAX.						at 120 Hz
9	Surge Voltage	Δ C/C : \pm 5% Tangent of loss angle: initial requirement Leakage Current : initial requirement						at 85°C, Rs = 1 k Ω 1000 cycles
10	Charac- teristics at high and low temperature	Temp.	-55°C		+85°C	+125°C		
		Δ C/C	0 -12 %		+12 0 %	+15 0 %		
		Tangent of loss angle	0.1 to 4.7 μ F: 0.08 MAX. 6.8 to 33 μ F : 0.10 MAX.		initial requirement	0.1 to 4.7 μ F: 0.06 MAX. 6.8 to 33 μ F : 0.08 MAX.		
		Leakge Current	—		0.1 CV or 5 μ A MAX.	0.125 CV or 6.25 μ A MAX.		
11	Rapid change of temperature	Δ C/C : \pm 10% Tangent of loss angle: initial requirement Leakage Current : initial requirement						IEC68-2-14 Test N and IEC68-22-33 Guidance -55°C to +125°C, 1000 cycles
12	Resistance to Soldering	Δ C/C : \pm 5% Tangent of loss angle: initial requirement Leakage Current : initial requirement						IEC68-2-58 Test Td Fully immersion to Solder 260°C, 10 sec
13	Damp Heat (steady state)	Δ C/C : \pm 10% Tangent of loss angle: 150% of initial requirement Leakage Current : initial requirement						IEC68-2-3 Test Ca at 85°C, 85% RH, 1000 h
14	Terminal Strength	There shall be no loosening or permanent damage						pull of 5N in an axial direction
15	Endurance (1)	Δ C/C : \pm 10% Tangent of loss angle: initial requirement Leakage Current : 125% of initial requirement						at 85°C, Rated Voltage applied 2000 h
16	Endurance (2)	Δ C/C : \pm 10% Tangent of loss angle: initial requirement Leakage Current : 125% of initial requirement						at 125°C, Derated Voltage applied 2000 h
17	Failure Rate	0.5%/1000 h						each condition of No. 15 and No. 16 above

STANDARD RATINGS

Rated Voltage (Vdc)	Capacitance (μ F)	Tangent of loss angle	Leakage Current (μ A)	Case Code	Part Number
10	2.2	0.04	0.5	A	SVHA1A225M
	4.7	0.04	0.5	B2	SVHB21A475M
	15	0.06	1.5	C	SVHC1A156M
	33	0.06	3.3	D2	SVHD21A336M
16	1	0.04	0.5	A	SVHA1C105M
	1.5	0.04	0.5	A	SVHA1C155M
	3.3	0.04	0.5	B2	SVHB21C335M
	10	0.06	1.6	C	SVHC1C106M
	22	0.06	3.5	D2	SVHD21C226M
20	0.68	0.04	0.5	A	SVHA1D684M
	2.2	0.04	0.5	B2	SVHB21D225M
	6.8	0.06	1.4	C	SVHC1D685M
	15	0.06	3.0	D2	SVHD21D156M
25	0.47	0.04	0.5	A	SVHA1E474M
	1.5	0.04	0.5	B2	SVHB21E155M
	4.7	0.04	1.1	C	SVHC1E475M
	10	0.06	2.5	D2	SVHD21E106M
35	0.1	0.04	0.5	A	SVHA1V104M
	0.15	0.04	0.5	A	SVHA1V154M
	0.22	0.04	0.5	A	SVHA1V224M
	0.33	0.04	0.5	A	SVHA1V334M
	0.47	0.04	0.5	B2	SVHB21V474M
	0.68	0.04	0.5	B2	SVHB21V684M
	1	0.04	0.5	B2	SVHB21V105M
	1.5	0.04	0.5	C	SVHC1V155M
	2.2	0.04	0.7	C	SVHC1V225M
	3.3	0.04	1.2	C	SVHC1V335M
	4.7	0.04	1.6	D2	SVHD21V475M
	6.8	0.06	2.3	D2	SVHD21V685M

TAPE AND REEL SPECIFICATION

Carrier Tape Dimensions and Packaging Quantity

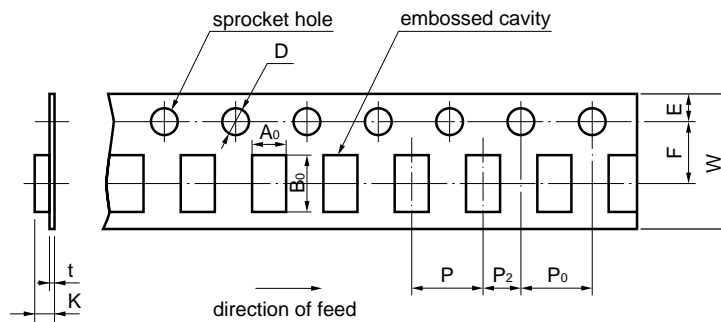

(Unit: mm)

Case Code	$A_0 \pm 0.2$	$B_0 \pm 0.2$	$W \pm 0.3$	$F \pm 0.05$	$E \pm 0.1$	$P \pm 0.1$	$P_2 \pm 0.05$
A	1.9	3.5	8.0	3.5	1.75	4.0	2.0
B2	3.3	3.8	8.0	3.5	1.75	4.0	2.0
C	3.7	6.4	12.0	5.5	1.75	8.0	2.0
D2	5.1	6.2	12.0	5.5	1.75	8.0	2.0

Case Code	$P_0 \pm 0.1$	$D +0.1$ 0	$K \pm 0.2$	t	Q'ty/Reel
A	4.0	$\phi 1.5$	1.9	0.2	2 000
B2	4.0	$\phi 1.5$	2.1	0.2	2 000
C	4.0	$\phi 1.5$	3.0	0.3	500
D2	4.0	$\phi 1.5$	3.6	0.4	500

Reel Dimensions

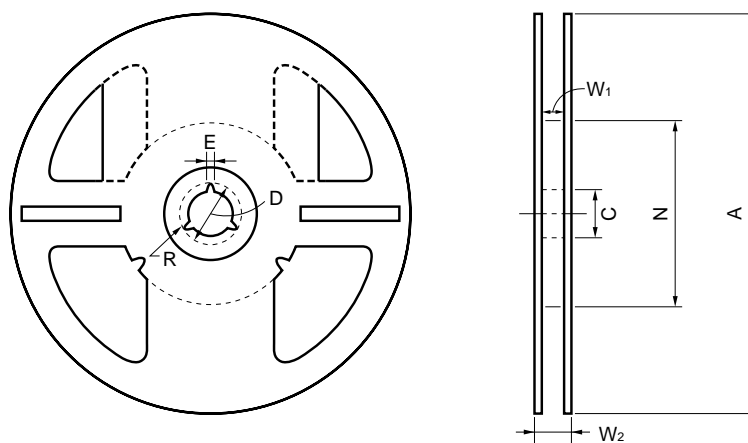

Tape Width

(Unit: mm)

Tape Width	A	N	C	D	E	W_1	W_2	R
8	$\phi 178 \pm 2.0$	$\phi 50$ Min.	$\phi 13 \pm 0.5$	$\phi 21 \pm 0.5$	2.0 ± 0.5	10.0 ± 1.0	14.5 max.	1
12	$\phi 178 \pm 2.0$	$\phi 50$ Min.	$\phi 13 \pm 0.5$	$\phi 21 \pm 0.5$	2.0 ± 0.5	14.5 ± 1.0	18.5 max.	1

CHARACTERISTICS DATA

Rapid change of temperature (-55°C to +125°C, n = 50)

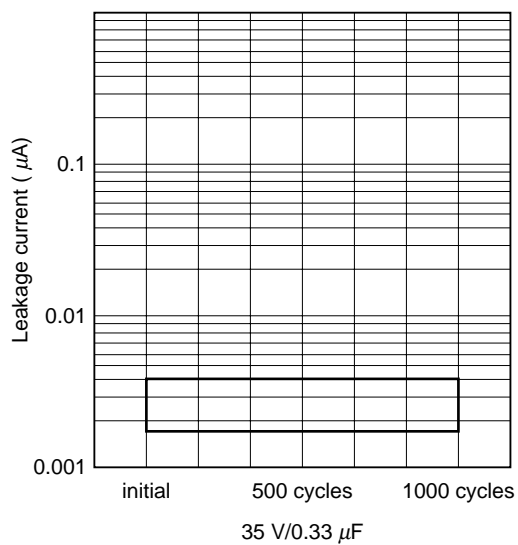
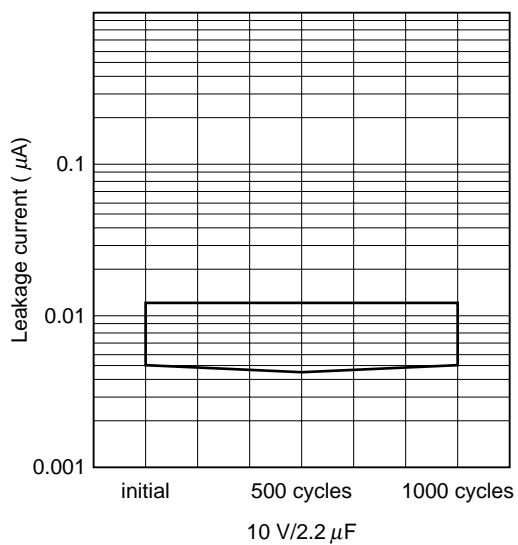
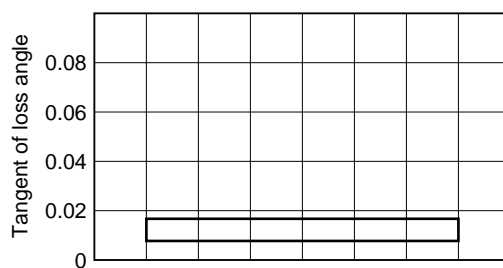
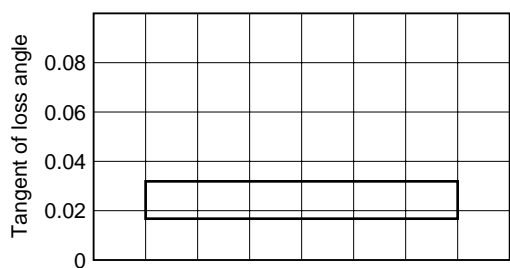
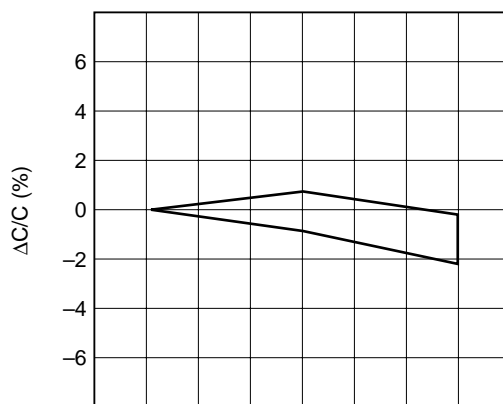
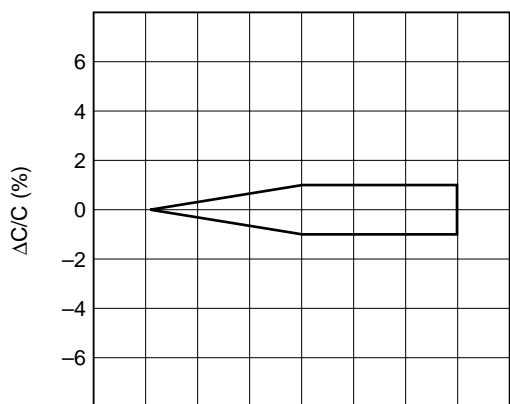

Rapid change of temperature (-55°C to +125°C, n = 50)

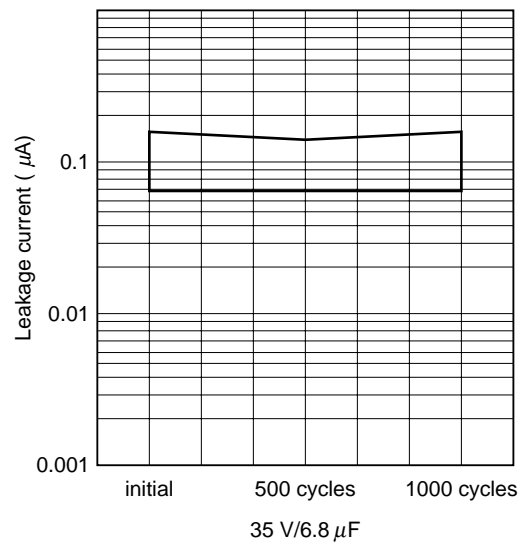
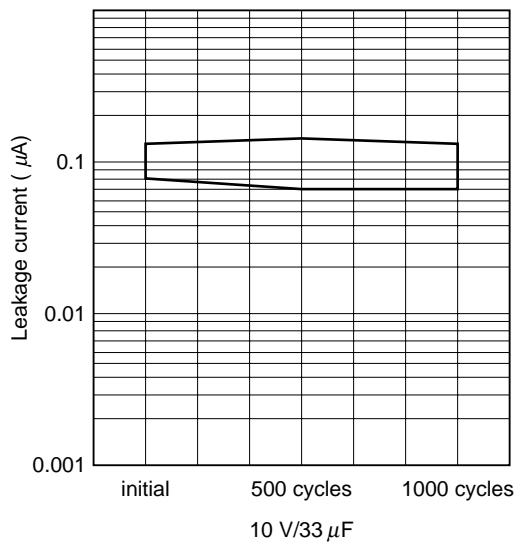
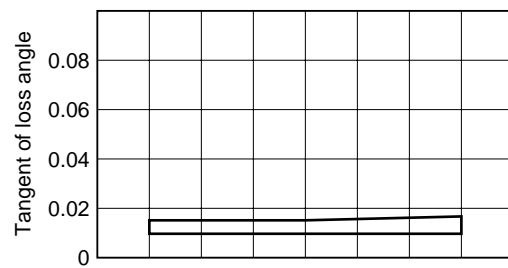
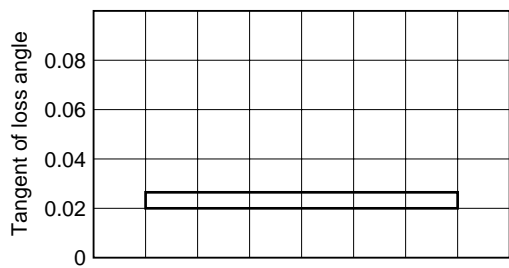
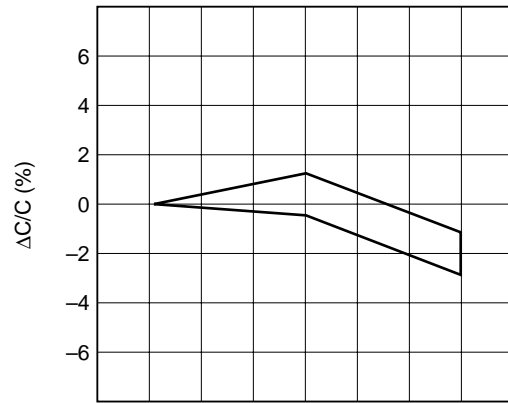
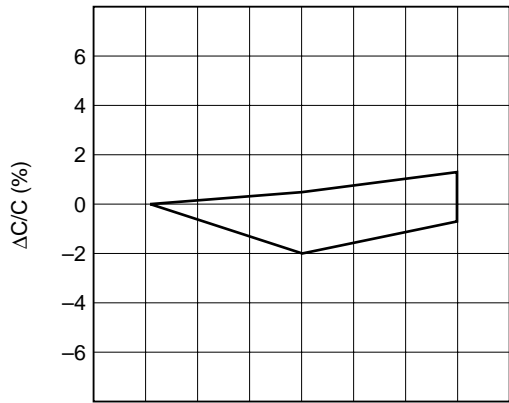

Damp heat (steady state) (85°C, 85% RH, n = 50)

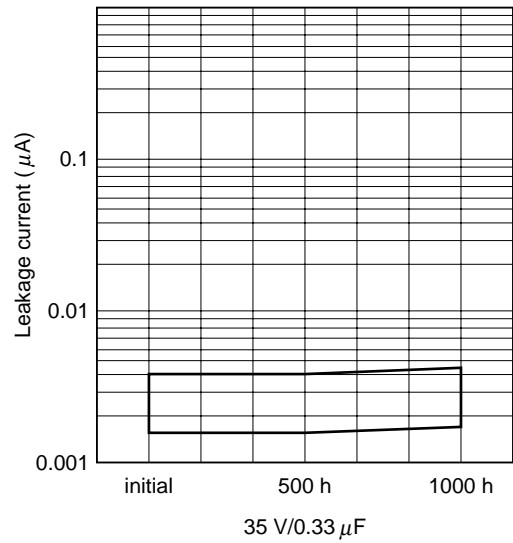
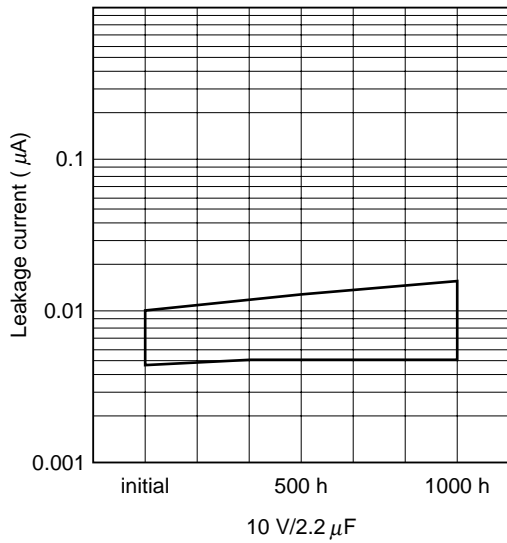
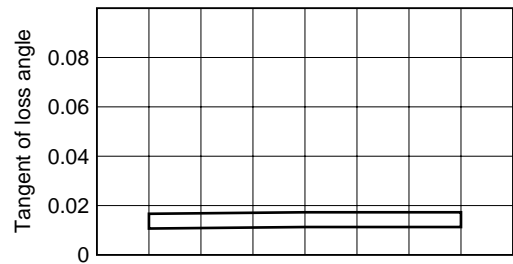
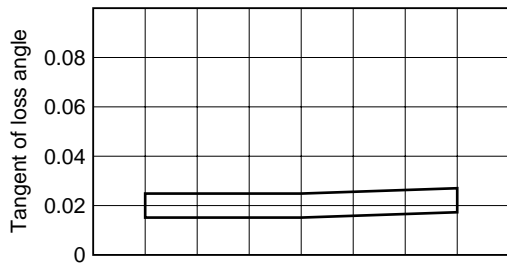
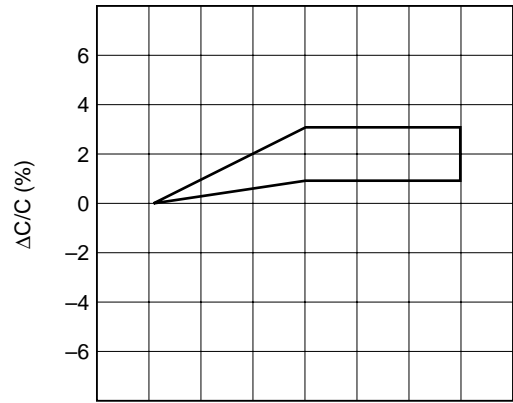
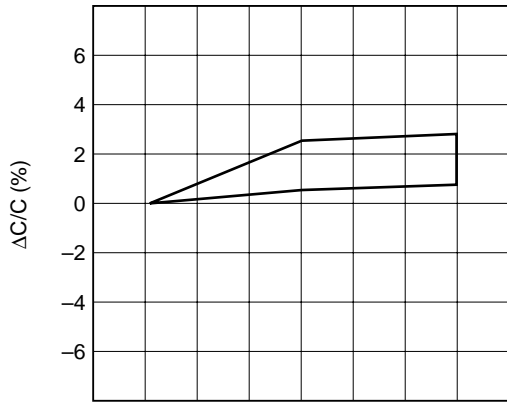

Damp heat (steady state) (85°C, 85% RH, n = 50)

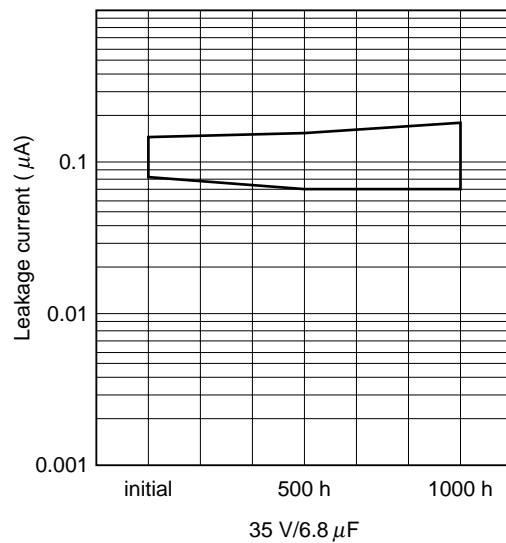
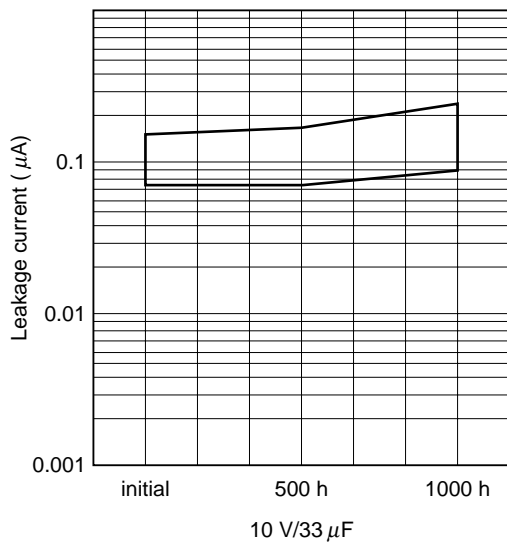
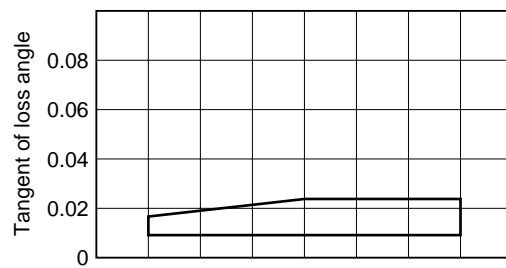
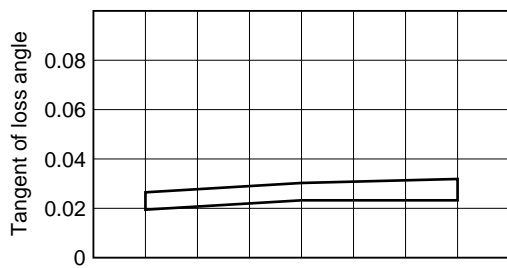
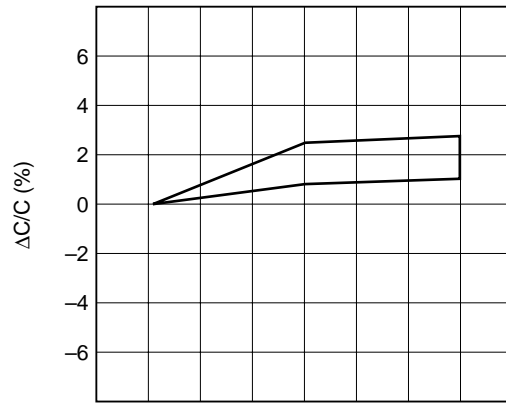
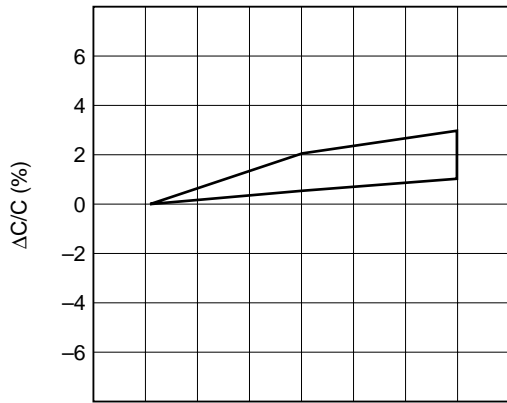

Endurance (85°C, $U_R \times 1.3$ applied, n = 50)

(reference data)

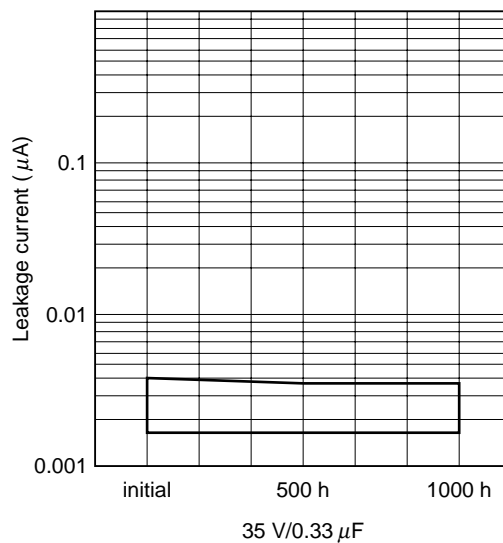
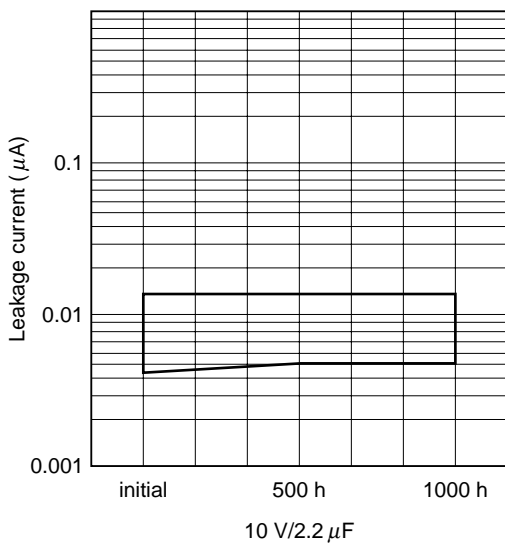
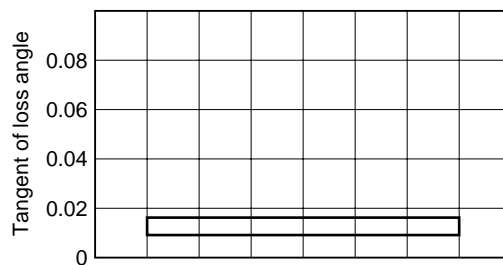
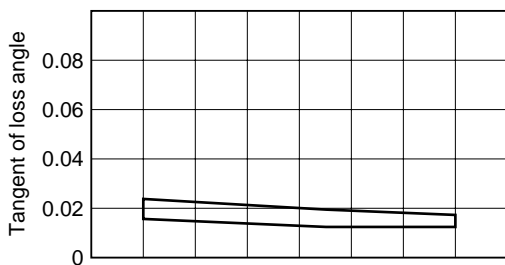
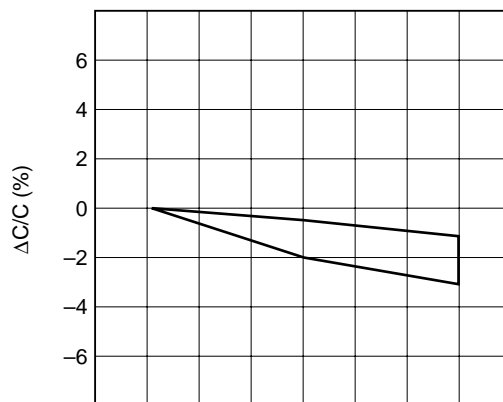
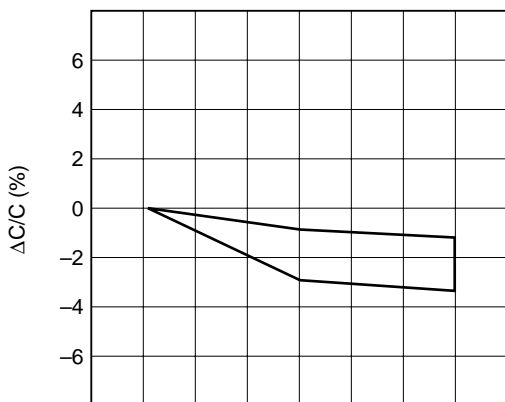

Endurance (85°C, $U_R \times 1.3$ applied, n = 50)

(reference data)

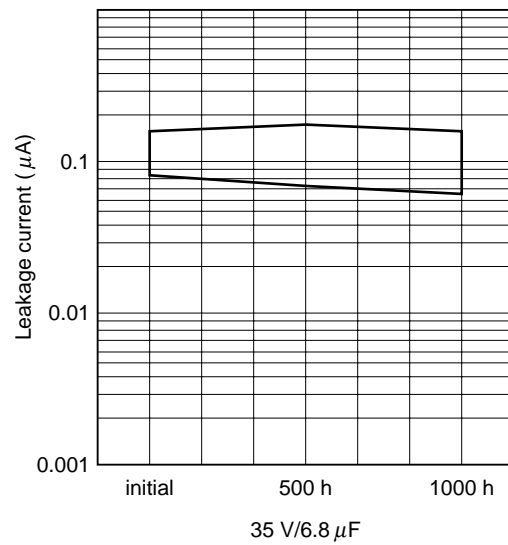
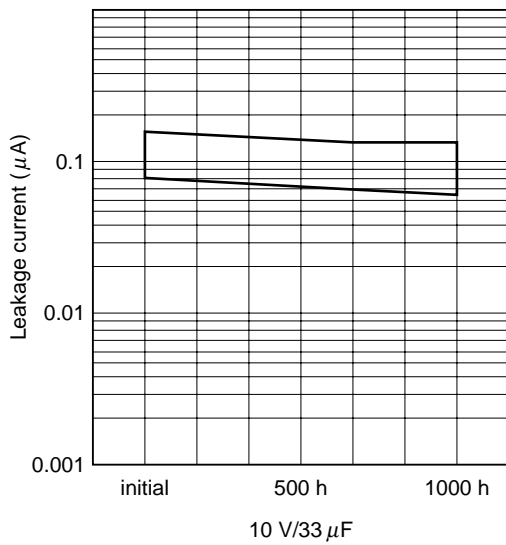
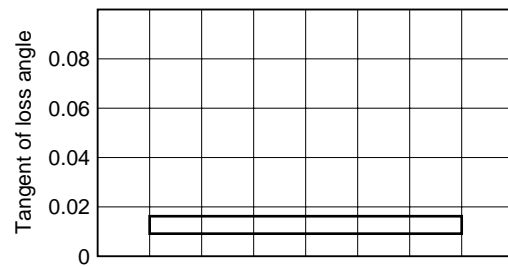
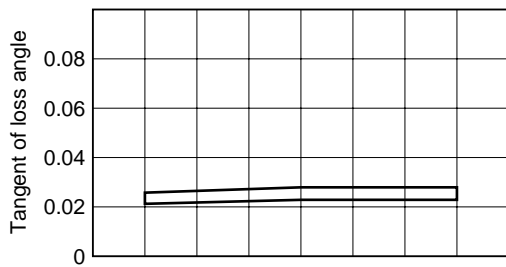
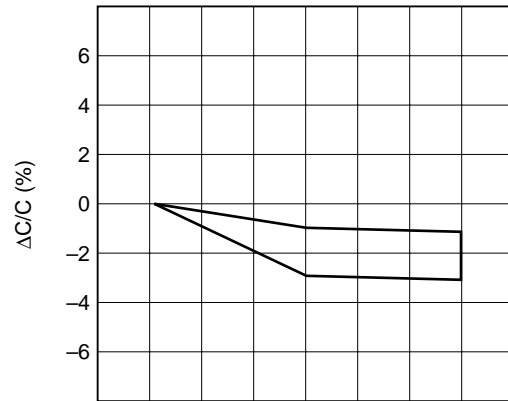
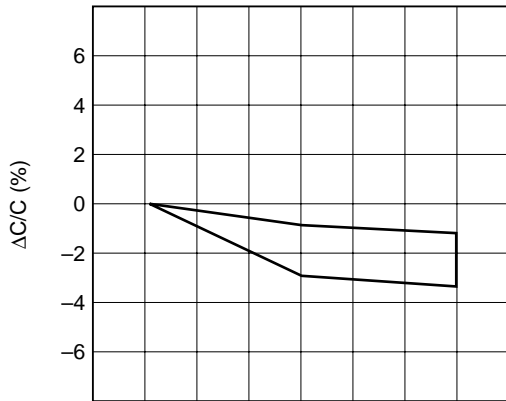

FREQUENCY CHARACTERISTIC (reference data)

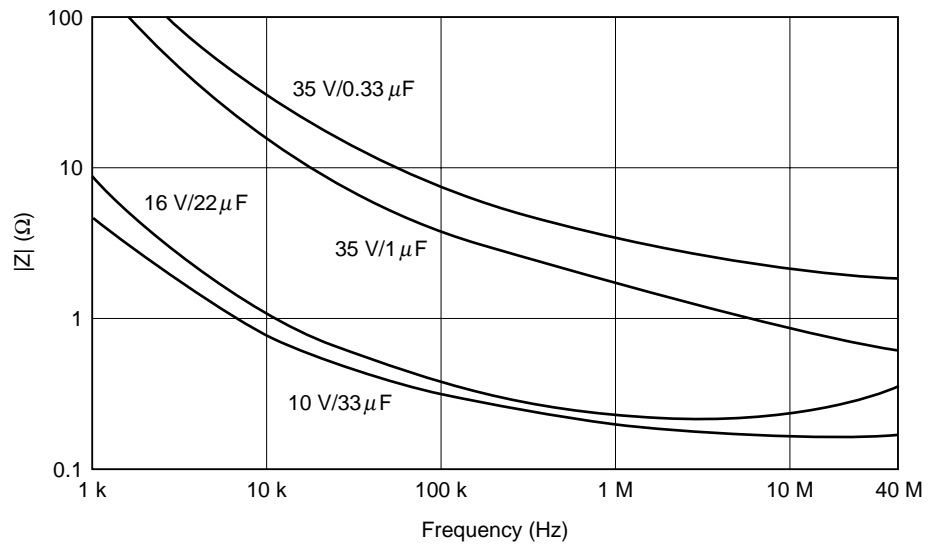

GUIDE TO APPLICATIONS FOR TANTALUM CHIP CAPACITORS

The failure of the solid tantalum capacitor is mostly classified into a short-circuiting mode and a large leakage current mode. Refer to the following for reliable circuit design.

1. Field failure rate

SV/H Series tantalum chip capacitors are typically applied to decoupling, blocking, by-passing and filtering.

The SV/H Series has a very low failure rate in the field. For example, the maximum field failure rate of an SV/H Series capacitor with a DC working voltage of 16 V is 0.0002 %/1000 hour (2 Fit) at an applied voltage of 5 V, operating temperature of 25°C and series resistance of 3 Ω.

The maximum failure rate in the field is estimated by following expression:

$$\lambda = \lambda_0 \left(\frac{V}{V_0} \right)^3 \times 2^{\left(\frac{T-T_0}{10} \right)}$$

λ : Maximum field failure rate

λ₀ : 0.5%/1000 hour (The failure rate of the SV/H Series at the full rated DC working voltage at operating temperature of 85°C and series resistance of 3 Ω.)

V : Applied voltage in actual use

V₀ : Rated DC working voltage

T : Operating temperature in actual use

T₀ : 85°C

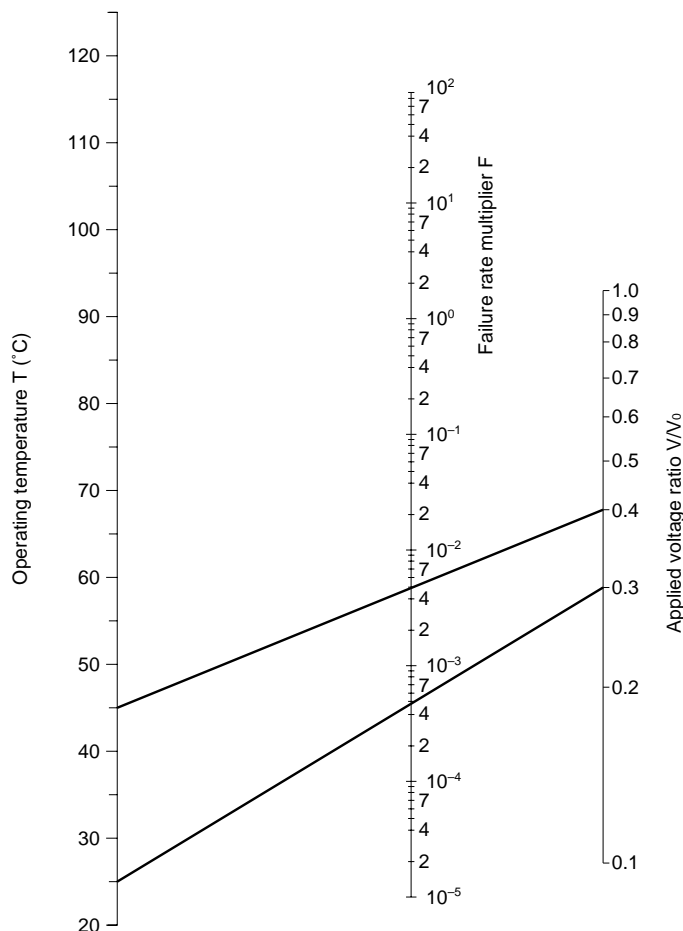

The nomograph is provided for quick estimation of maximum field failure rates.

Connect operating temperature T and applied voltage ratio V/V₀ of interest with a straight line. The failure rate multiplier F is given at the intersection of this line with the model scale. The failure rate is obtained as λ = λ₀·F.

Examples:

Given V/V₀ = 0.4 and T = 45°C, read F = 4 × 10⁻³.

Hence, λ = 0.002%/1000 hour (20 Fit).

Given V/V₀ = 0.3 and T = 25°C, read F = 4 × 10⁻⁴.

Hence, λ = 0.0002%/1000 hour (2 Fit).

2. Series resistance

As shown in Figure 1, reliability is increased by inserting a series resistance of at least 3 Ω/V into circuits where current flow is momentary (switching circuits, charge/discharge circuits, etc.).

If the capacitor is in a low-impedance circuit, the voltage applied to the capacitor should be less than 1/2 to 1/3 of the rated DC working voltage.

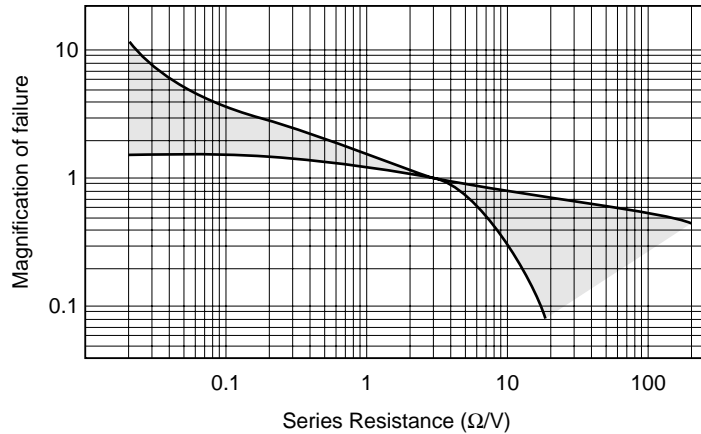

Figure 1. Effects of Series Resistance

3. Ripple voltage

The sum of DC voltage and peak ripple voltage should not exceed the rated DC working voltage of the capacitor.

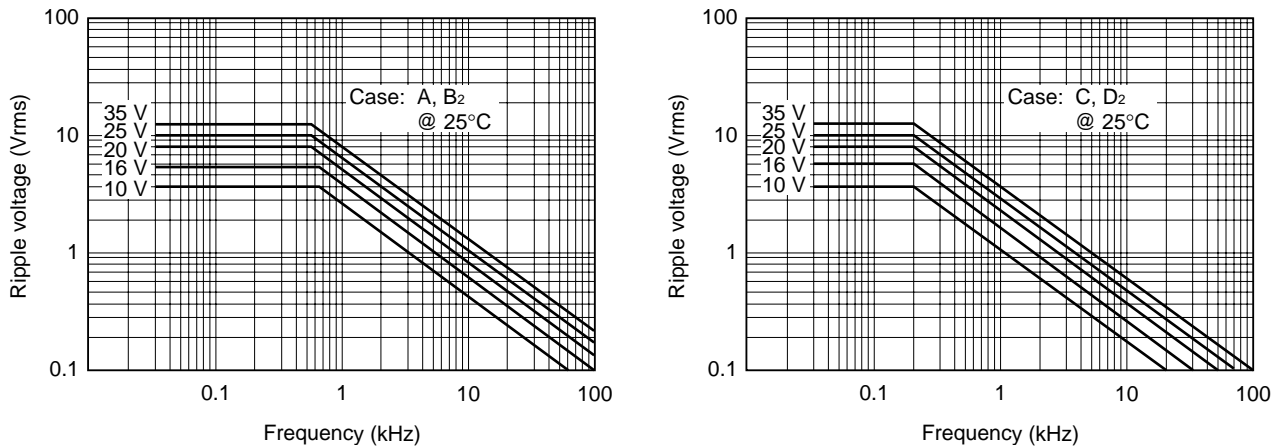

Figure 2. Permissible Ripple Voltage vs. Frequency

Figure 2 is based on an ambient temperature of 25°C. For higher temperature, permissible ripple voltage shall be derated as follows.

- Permissible voltage @ 50°C = 0.7 × permissible voltage @25°C
- Permissible voltage @ 85°C = 0.5 × permissible voltage @25°C
- Permissible voltage @ 125°C = 0.3 × permissible voltage @25°C

4. Reverse voltage

Because the capacitors are polarized, reverse voltage should not be applied.

If reverse voltage cannot be avoided because of circuit design, the voltage application should be for a very short time and should not exceed the following.

- 10% MAX. of rated DC working voltage @25°C
- 5% MAX. of rated DC working voltage @85°C
- 1% MAX. of rated DC working voltage @125°C

5. Mounting

(1) Direct soldering

Keep in mind the following points when soldering the capacitor by means of jet soldering or dip soldering:

(a) Temporarily fixing resin

Because the SV/H series solid tantalum capacitors are larger in size and subject to more force than the chip multilayer ceramic capacitors or chip resistors, more resin is required to temporarily secure the solid tantalum capacitors. However, if too much resin is used, the resin adhering to the patterns on a printed circuit board may adversely affect the solderability.

(b) Pattern design

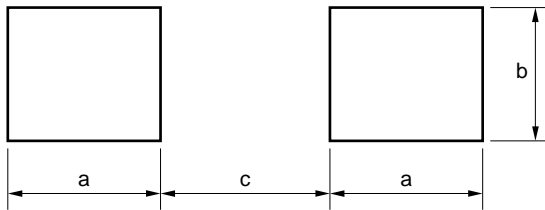

Case	a	b	c
A	2.9	1.7	1.2
B2	3.0	2.8	1.6
C	4.1	2.3	2.4
D2	5.4	2.9	2.4

The above dimensions are for reference only. If the capacitor is to be mounted by this method, and if the pattern is too small, the solderability may be degraded.

(c) Temperature and time

Keep the peak temperature and time to within the following values:

- Solder temperature 260°C max.
- Time 10 seconds max.

Whenever possible, perform preheating (at 150°C max.) for smooth temperature profile. To maintain the reliability, mount the capacitor at a low temperature and in a short time whenever possible.

(d) Component layout

If many types of chip components are mounted on a printed circuit board which is to be soldered by means of jet soldering, solderability may not be uniform over the entire board depending on the layout and density of the components on the board (also take into consideration generation of flux gas).

(e) Flux

Use resin-based flux. Do not use flux with strong acidity.

(2) Reflow soldering

Keep in mind the following points when soldering the capacitor in a soldering oven or with a hot plate:

(a) Pattern design

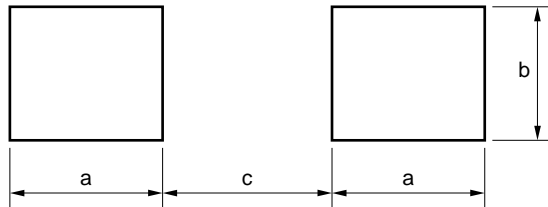

Case	a	b	c
A	1.6	1.7	1.2
B2	1.6	2.8	1.6
C	2.4	2.3	2.4
D2	2.4	2.9	2.4

The above dimensions are for reference only. Note that if the pattern is too big, the component may not be mounted in place.

(b) Temperature and time

Keep the peak temperature and time to within the following values:

Solder temperature 260°C max.

Time: 10 seconds max.

Whenever possible, perform preheating (at 150°C max.) for smooth temperature profile. To maintain the reliability, mount the capacitor at a low temperature and in a short time whenever possible. The peak temperature and time shown above are applicable when the capacitor is to be soldered in a soldering oven or with a hot plate. When the capacitor is soldered by means of infrared reflow soldering, the internal temperature of the capacitor may rise beyond the surface temperature.

(3) Using soldering iron

When soldering the capacitor with a soldering iron, controlling the temperature at the tip of the soldering iron is very difficult. However, it is recommended that the following temperature and time be observed to maintain the reliability of the capacitor:

Iron temperature 300°C max.

Time 3 seconds max.

Iron power 30 W max.

6. Cleaning

Generally, several organic solvents are used for flux cleaning of an electronic component after soldering. Many cleaning methods, such as immersion cleaning, rinse cleaning, brush cleaning, shower cleaning, vapor cleaning, and ultrasonic cleaning, are available, and one of these cleaning methods may be used alone or two or more may be used in combination. The temperature of the organic solvent may vary from room temperature to several 10°C, depending on the desired effect. If cleaning is carried out with emphasis placed only on cleaning effect, however, the marking on the electronic component cleaned may be erased, the appearance of the component may be damaged, and in the worst case, the component may be functionally damaged. It is therefore recommended that the R series solid tantalum capacitor be cleaned under the following conditions:

[Recommended conditions of flux cleaning]

- (1) Cleaning solvent Chlorosen, isopropyl alcohol
- (2) Cleaning method Shower cleaning, rinse cleaning, vapor cleaning
- (3) Cleaning time 5 minutes max.

*Ultrasonic cleaning

This cleaning method is extremely effective for eliminating dust that has been generated as a result of mechanical processes, but may pose a problem depending on the condition. As a result of an experiment conducted by NEC, it was confirmed that the external terminals of the capacitor were cut when it was cleaned with some ultrasonic cleaning machines. The cause of this phenomenon is considered metal fatigue of the capacitor terminals that occurred due to ultrasonic cleaning. To prevent the terminal from being cut, decreasing the output power of the ultrasonic cleaning machine or shortening the cleaning time may be a possible solution. However, it is difficult to specify the safe cleaning conditions because there are many factors involved such as the conversion efficiency of the ultrasonic oscillator, transfer efficiency of the cleaning bath, difference in cleaning effect depending on the location in the cleaning bath, the size and quantity of the printed circuit boards to be cleaned, and the securing states of the components on the boards. It is therefore recommended that ultrasonic cleaning be avoided as much as possible.

If ultrasonic cleaning is essential, make sure through experiments that no abnormality occur as a result of the cleaning. For further information, consult NEC.

7. Others

- (1) Do not apply excessive vibration and shock to the capacitor.
- (2) The solderability of the capacitor may be degraded by humidity. Store the capacitor at (–5 to +40°C) room temperature and (40 to 60% RH) humidity.
- (3) Exercise care that no external force is applied to the tape packaged products (if the packaging material is deformed, the capacitor may not be automatically mounted by a chip mounted).

No part of this document may be copied or reproduced in any form or by any means without the prior written consent of NEC Corporation. NEC Corporation assumes no responsibility for any errors which may appear in this document.

NEC Corporation does not assume any liability for infringement of patents, copyrights or other intellectual property rights of third parties by or arising from use of a device described herein or any other liability arising from use of such device. No license, either express, implied or otherwise, is granted under any patents, copyrights or other intellectual property rights of NEC Corporation or others.

While NEC Corporation has been making continuous effort to enhance the reliability of its electronic components, the possibility of defects cannot be eliminated entirely. To minimize risks of damage or injury to persons or property arising from a defect in an NEC electronic component, customers must incorporate sufficient safety measures in its design, such as redundancy, fire-containment, and anti-failure features. NEC devices are classified into the following three quality grades:

"Standard," "Special," and "Specific". The Specific quality grade applies only to devices developed based on a customer designated "quality assurance program" for a specific application. The recommended applications of a device depend on its quality grade, as indicated below. Customers must check the quality grade of each device before using it in a particular application.

Standard: Computers, office equipment, communications equipment, test and measurement equipment, audio and visual equipment, home electronic appliances, machine tools, personal electronic equipment and industrial robots

Special: Transportation equipment (automobiles, trains, ships, etc.), traffic control systems, anti-disaster systems, anti-crime systems, safety equipment and medical equipment (not specifically designed for life support)

Specific: Aircrafts, aerospace equipment, submersible repeaters, nuclear reactor control systems, life support systems or medical equipment for life support, etc.

The quality grade of NEC devices is "Standard" unless otherwise specified in NEC's Data Sheets or Data Books. If customers intend to use NEC devices for applications other than those specified for Standard quality grade, they should contact an NEC sales representative in advance.

(Note)

- (1) "NEC" as used in this statement means NEC Corporation and also includes its majority-owned subsidiaries.
- (2) "NEC electronic component products" means any electronic component product developed or manufactured by or for NEC (as defined above).