

Features

- Colorless transparency lens type
- $\phi 3\text{mm}$ (T-1) all plastic mold type
- White emission color : X=0.23~0.32
Y=0.20~0.37
- Viewing angle : $\pm 22^\circ$ / Super luminosity
- E ; ESD Protected (IEC 61000-4-2 $\pm 7\text{V}$ (contact mode))

Outline Dimensions

unit : mm

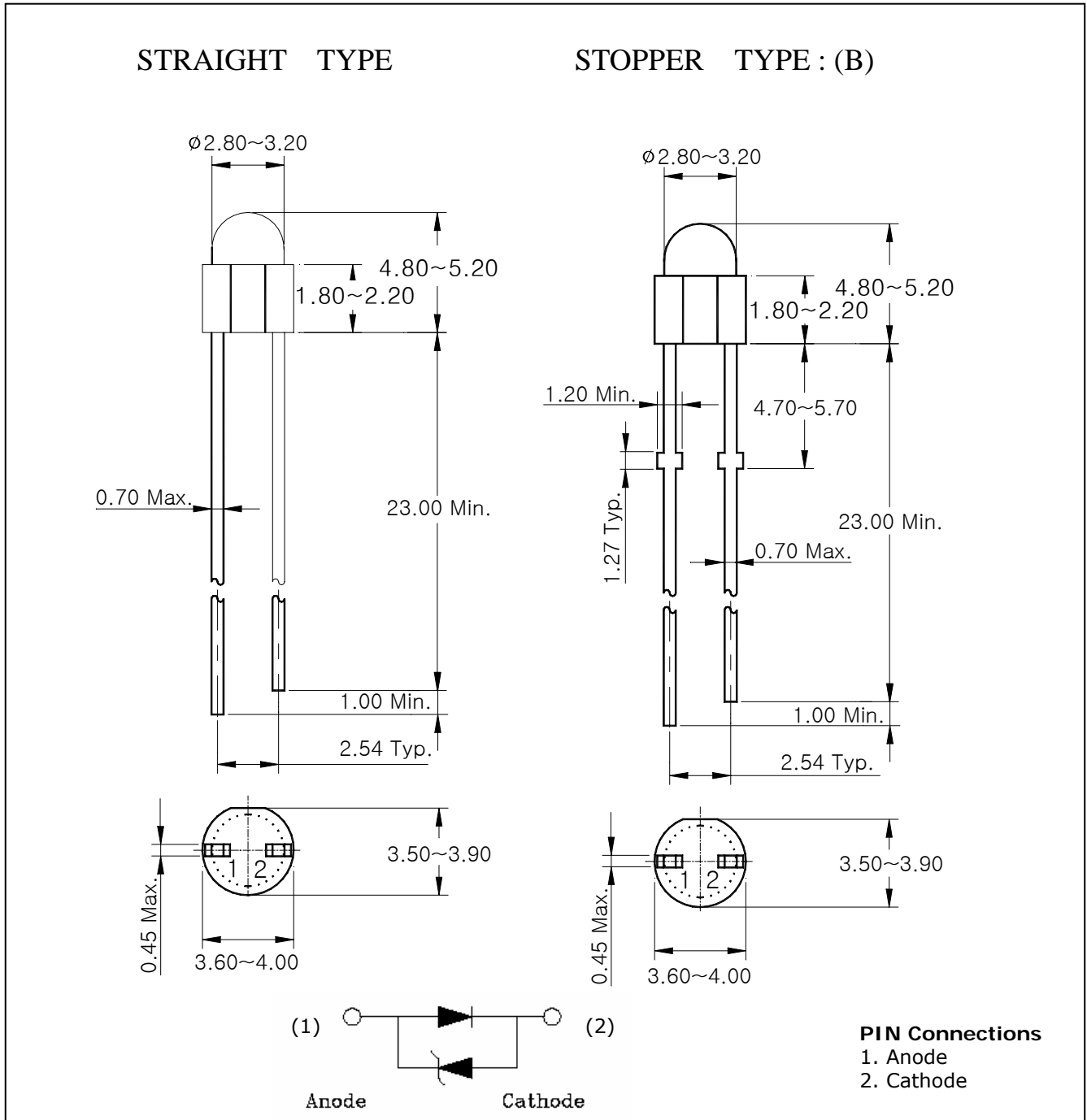

SW3372E-H / SW3372E-H(B)

Absolute Maximum Ratings

(Ta=25°C)

Characteristic	Symbol	Rating	Unit
Power dissipation	P_D	110	mW
Forward current	I_F	30	mA
*1Peak forward current	I_{FP}	50	mA
Operating temperature range	T_{opr}	-25~85	°C
Storage temperature range	T_{stg}	-30~100	°C
*2Soldering temperature	T_{sol}	260°C for 10 seconds	

*1.Duty ratio = 1/16, Pulse width = 0.1ms

*2.Keep the distance more than 2.0mm from PCB to the bottom of LED package

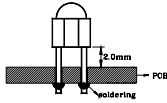

- ※ Recommend document
- . LED is very sensitive to ESD.

Electrical / Optical Characteristics

(Ta=25°C)

Characteristic	Symbol	Test Condition	Min.	Typ.	Max.	Unit
Forward voltage	V_F	$I_F= 20mA$	3.0	-	3.6	V
*5 Luminous intensity	I_V	$I_F= 20mA$	1760	-	3200	mcd
*3Chromaticity coordinates	X	$I_F= 20mA$	0.23	-	0.32	-
	Y		0.20	-	0.37	-
*4Half angle	$\theta_{1/2}$	$I_F= 20mA$	-	± 22	-	deg

*3. The chromaticity coordinates are derived from the CIE 1931 Chromaticity Diagram and represent the perceived color of the device.

*4. $\theta_{1/2}$ is the off-axis angle where the luminous intensity is 1/2 the peak intensity

*5. Luminous intensity maximum tolerance for each grade classification limit is $\pm 18\%$

- V_F / I_V Grade Classification (Ta=25°C)

Test Condition @ $I_F=20mA$	
Forward Voltage [V]	Luminous Intensity [mcd]
1 : 3.0~3.2	$S_1 : 1760\sim 2100$
2 : 3.2~3.4	$S_2 : 2100\sim 2640$
3 : 3.4~3.6	$T_1 : 2640\sim 3200$

Characteristic Diagrams

Fig. 1 $I_F - V_F$

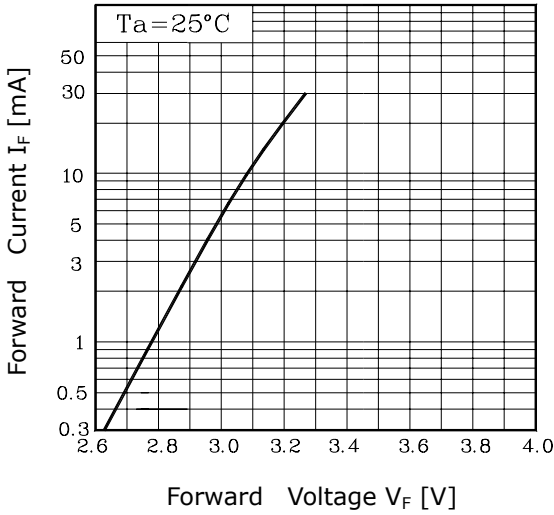

Fig. 2 $I_V - I_F$

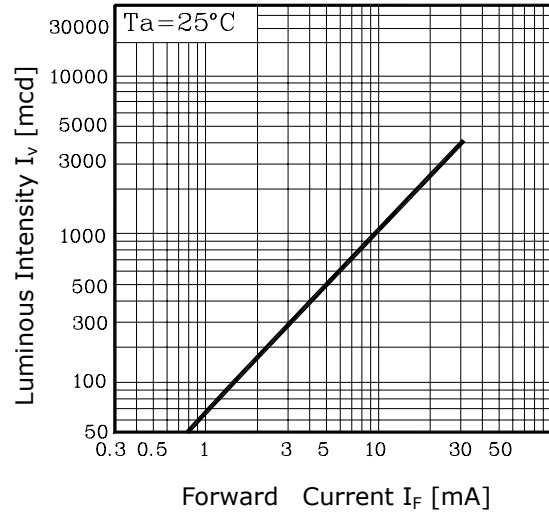

Fig. 3 $I_F - T_a$

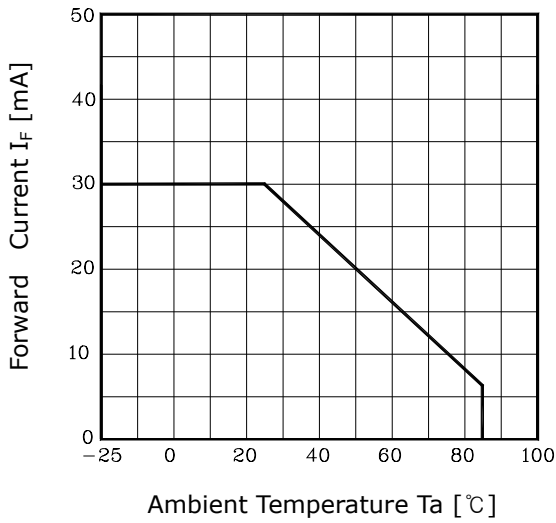

Fig. 4 Spectrum Distribution

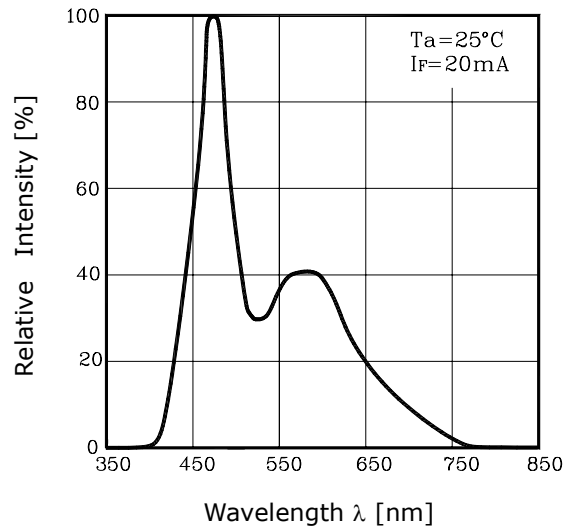
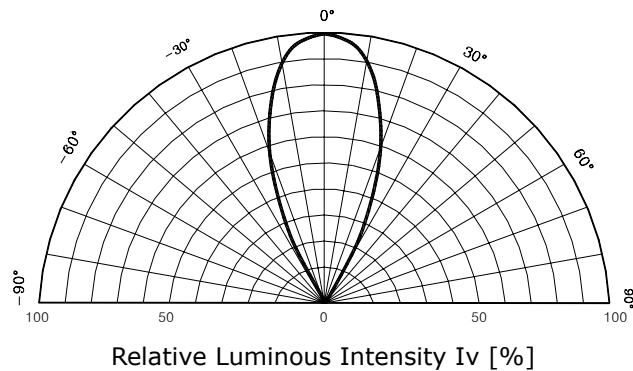
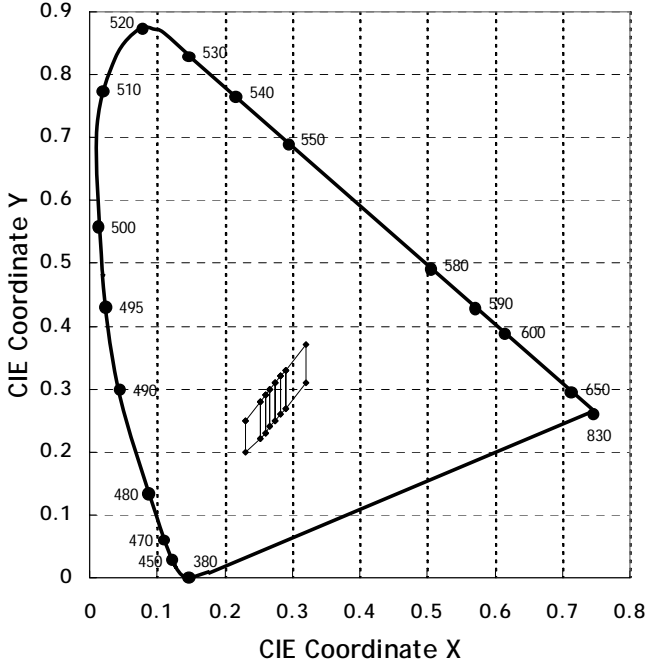
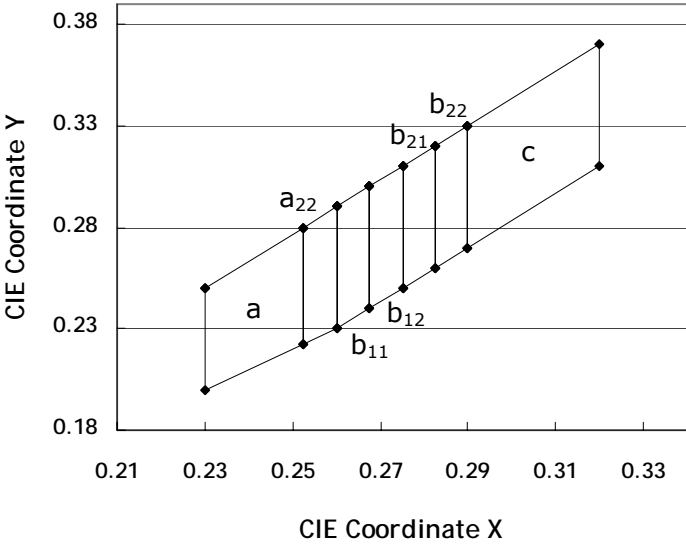

Fig. 5 Radiation Diagram



◆ CIE 1931 UCS Diagram



• CIE Coordinates Grade Classification (Ta=25°C, If=20mA)

Color Bin	CIE Coordinates		Color Bin	CIE Coordinates	
	X	Y		X	Y
a	0.23	0.25	a ₂₂	0.2525	0.28
	0.23	0.20		0.2525	0.222
	0.2525	0.222		0.26	0.23
	0.2525	0.28		0.26	0.29
b ₁₁	0.26	0.29	b ₁₂	0.2675	0.3
	0.26	0.23		0.2675	0.24
	0.2675	0.24		0.275	0.25
	0.2675	0.3		0.275	0.31
b ₂₁	0.275	0.31	b ₂₂	0.2825	0.32
	0.275	0.25		0.2825	0.26
	0.2825	0.26		0.29	0.27
	0.2825	0.32		0.29	0.33
c	0.29	0.33			
	0.29	0.27			
	0.32	0.31			
	0.32	0.37			

(Do not use to combine grade classification. It must be used separately grade classification)

The AUK Corp. products are intended for the use as components in general electronic equipment (Office and communication equipment, measuring equipment, home appliance, etc.).

Please make sure that you consult with us before you use these AUK Corp. products in equipments which require high quality and / or reliability, and in equipments which could have major impact to the welfare of human life(atomic energy control, airplane, spaceship, transportation, combustion control, all types of safety device, etc.). AUK Corp. cannot accept liability to any damage which may occur in case these AUK Corp. products were used in the mentioned equipments without prior consultation with AUK Corp..

Specifications mentioned in this publication are subject to change without notice.