

32 dBm Ku-Band Amplifier

TGA2503-SM



Key Features

- Typical Frequency Range: 12.5 - 16 GHz
- 32 dBm Nominal Psat
- 32 dB Nominal Gain
- 37 dBm Output TOI @ Pin = -20dBm
- 8 dB Typical Return Loss
- Bias Conditions: Vd = 6V, Idq = 600 mA (Id = 1200mA under RF drive)
- Package Dimensions: 4.0 x 4.0 x 0.9 mm

Primary Applications

- Ku-Band VSAT
- Point-to-Point Radio

Product Description

The TriQuint TGA2503-SM is a Ku-Band Packaged Power Amplifier. The TGA2503-SM operates from 12.5-16 GHz and is designed using TriQuint's proven standard 0.5-um power pHEMT production process.

The TGA2503-SM typically provides 32 dBm of saturated output power with small signal gain of 32 dB.

The TGA2503-SM is ideally suited for the VSAT ground terminal market and Point-to-Point Radio.

Evaluation Boards are available upon request.

Lead-free and RoHS compliant

Measured Performance
Bias Conditions: Vd = 6 V, Idq = 600 mA

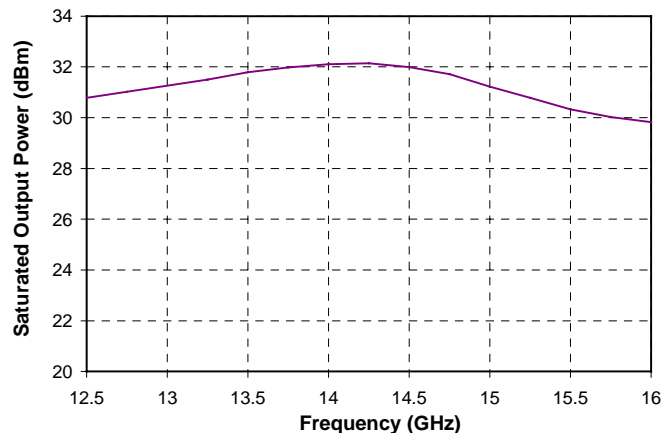
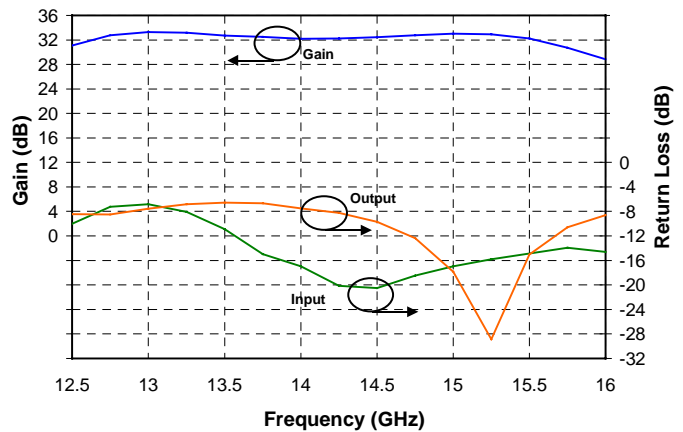

Note: This device is early in the characterization process prior to finalizing all electrical specifications. Specifications are subject to change without notice.

**TABLE I
MAXIMUM RATINGS**

Symbol	Parameter <u>1/</u>	Value	Notes
V ⁺	Positive Supply Voltage	8 V	<u>2/</u>
V ⁻	Negative Supply Voltage Range	-5V to 0V	
I ⁺	Positive Supply Current	1.3 A	<u>2/</u>
I _G	Gate Supply Current	18 mA	
P _{IN}	Input Continuous Wave Power	21 dBm	<u>2/</u>
P _D	Power Dissipation	See note 3	<u>2/ 3/</u>
T _{CH}	Operating Channel Temperature	150 °C	<u>4/ 5/</u>
T _M	Mounting Temperature (30 Seconds)	260 °C	
T _{STG}	Storage Temperature	-65 to 150 °C	

1/ These ratings represent the maximum operable values for this device.

2/ Combinations of supply voltage, supply current, input power, and output power shall not exceed P_D.

3/ For a median life time of 1E+6 hrs, Power dissipation is limited to:
 $PD(max) = (150\text{ °C} - T_{BASE}\text{ °C}) / 11.7\text{ (°C/W)}$

4/ These ratings apply to each individual FET.

5/ Junction operating temperature will directly affect the device median time to failure (T_M). For maximum life, it is recommended that junction temperatures be maintained at the lowest possible levels.

TABLE II
RF CHARACTERIZATION TABLE
 (T_A = 25°C, Nominal)
 Bias Conditions: V_d = 6V, I_{dq} = 600mA

SYMBOL	PARAMETER	TEST CONDITION	NOMINAL *	UNITS
Gain	Small Signal Gain	f = 12.5 – 16 GHz	32	dB
IRL	Input Return Loss	f = 12.5 – 16 GHz	10	dB
ORL	Output Return Loss	f = 12.5 – 16 GHz	8	dB
NF	Noise Figure	f = 12.5 – 16 GHz	9	dB
Psat	Saturated Output Power	f = 12.5 – 16 GHz f = 13.75 – 14.5 GHz	31 32	dBm
TOI	Third Order Intercept @ Pin = -20dBm	f = 12.5 – 16 GHz	36	dBm

* Note:

All measured data is taken using connectorized evaluation boards. The reference plane is at RF connectors, and hence connector and board loss has not been de-embedded.

TABLE III
THERMAL INFORMATION

PARAMETER	TEST CONDITION	T _{CH} (°C)	R _{θjc} (°C/W)	MTTF (HRS)
R _{θjc} Thermal Resistance (Channel to package)	V _D = 6 V I _D = 600 mA P _{Diss} = 3.6 W	127	11.7	7.9 E+6

Note: Backside of package is at 85 °C baseplate temperature. Worst case is at saturated output power when DC power consumption rises to 7.2 W with 1.5 W RF power delivered to load. Power dissipated is 5.7 W and the temperature rise in the channel is 67 °C. Baseplate temperature must be reduced to 83 °C to remain below the 150 °C maximum channel temperature.

Measured Performance*

Bias Conditions: $V_d = 6\text{ V}$, $I_{dq} = 600\text{ mA}$

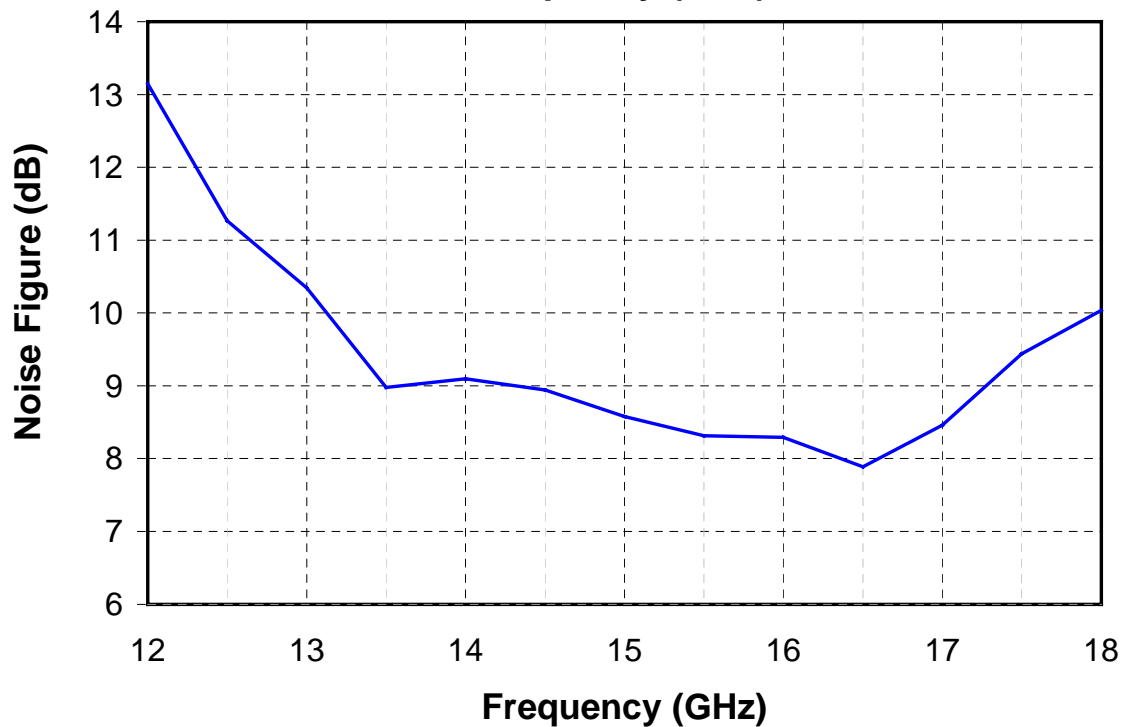
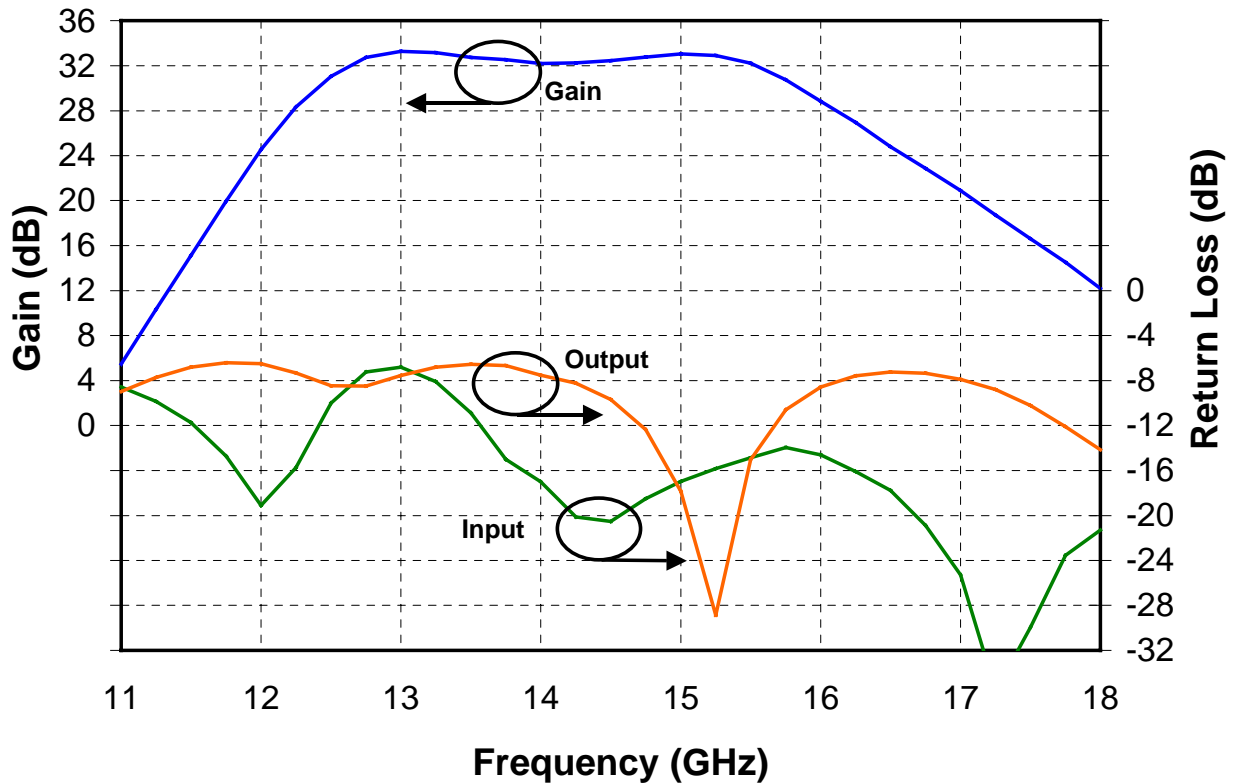

* Note:

All measured data is taken using connectorized evaluation boards. The reference plane is at RF connectors, and hence connector and board loss has not been de-embedded.

Measured Performance

Bias Conditions: $V_d = 6\text{ V}$, $I_{dq} = 600\text{ mA}$

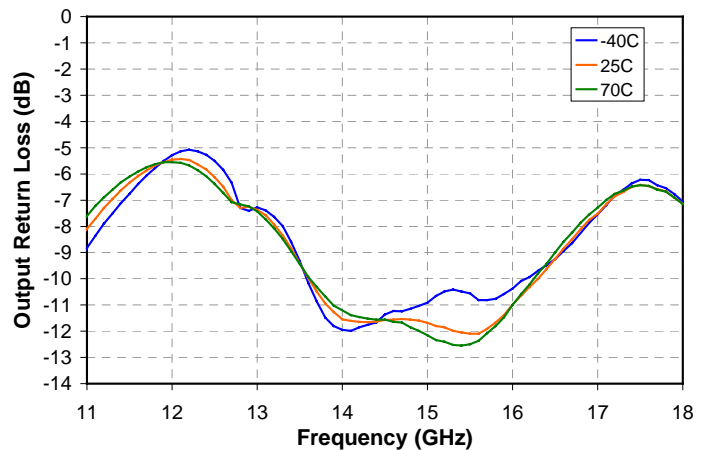
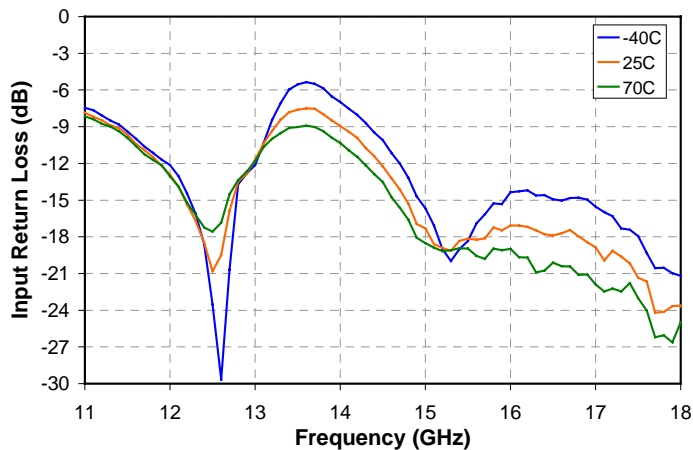
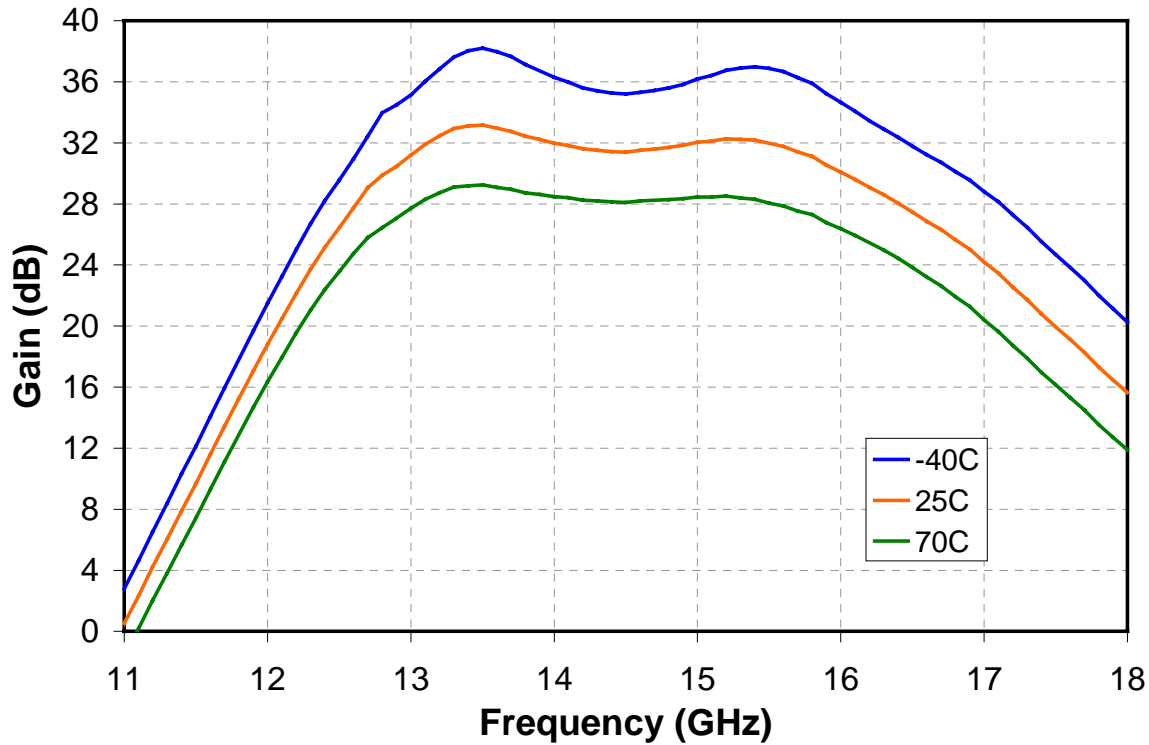

* Note:

All measured data is taken using connectorized evaluation boards. The reference plane is at RF connectors, and hence connector and board loss has not been de-embedded.

Measured Performance

Bias Conditions: $V_d = 6\text{ V}$, $I_{dq} = 600\text{ mA}$

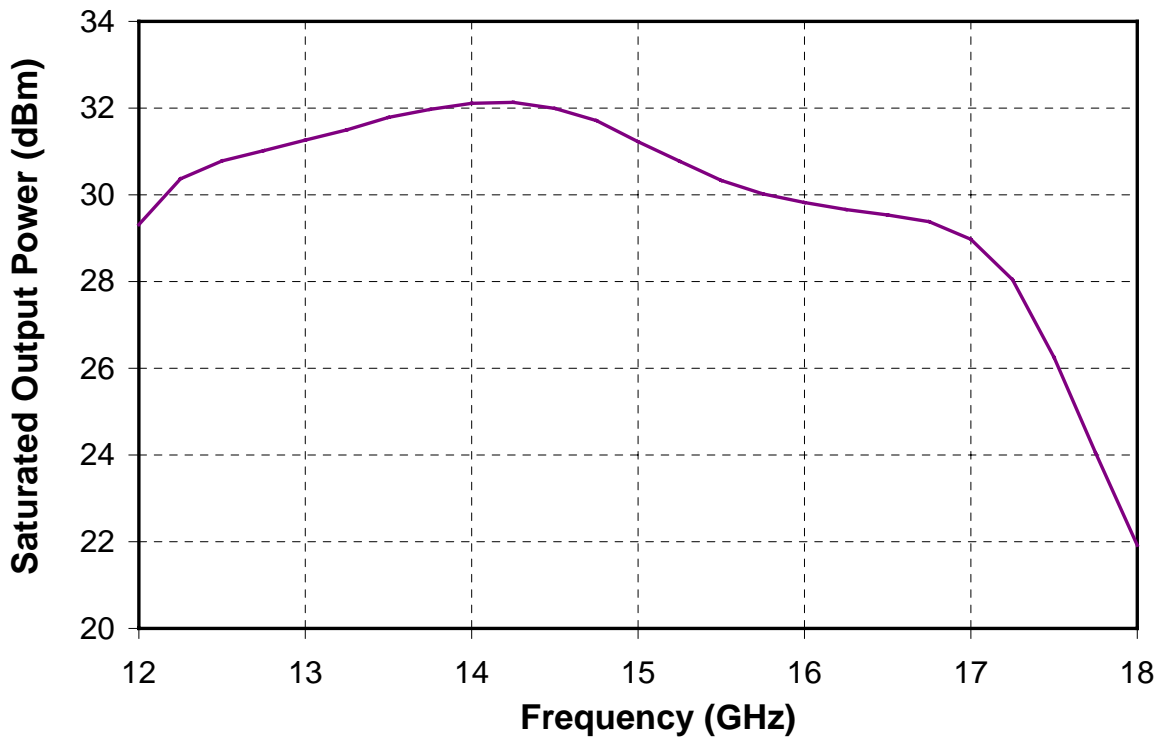
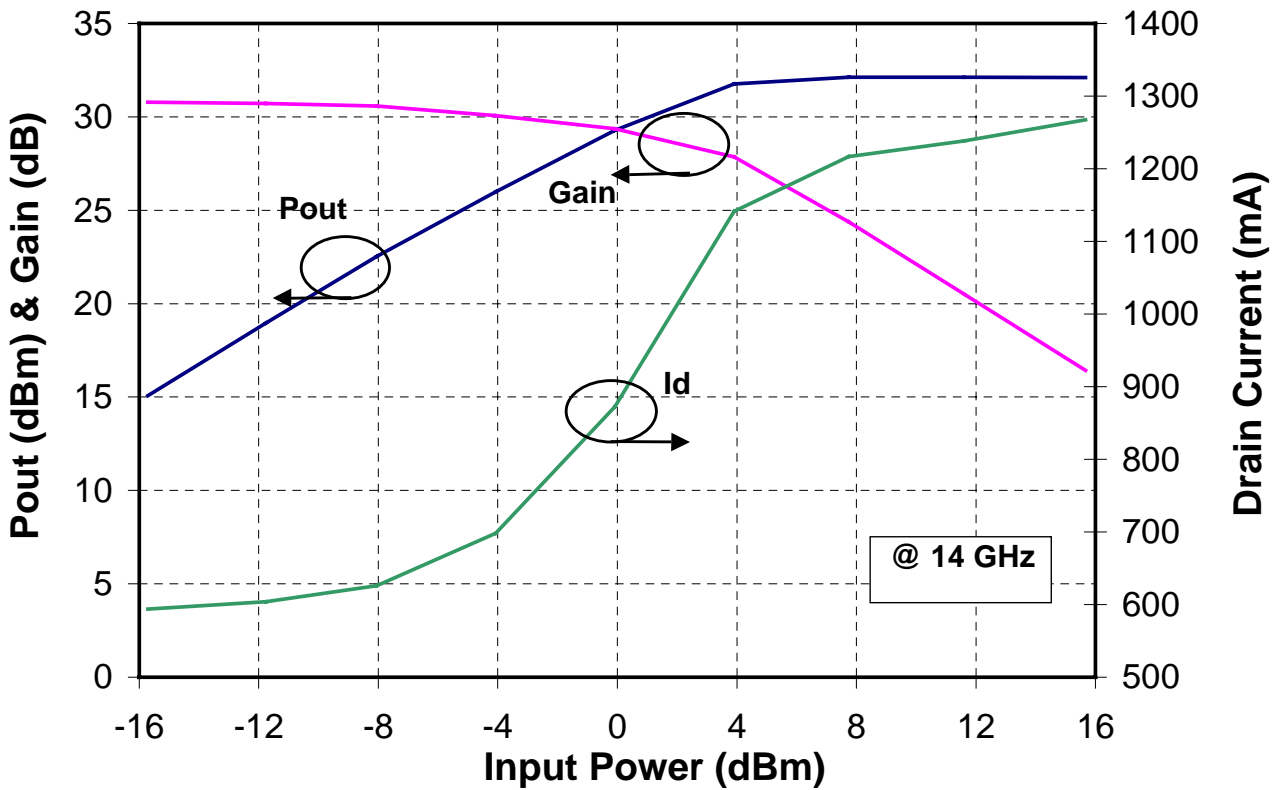

* Note:

All measured data is taken using connectorized evaluation boards. The reference plane is at RF connectors, and hence connector and board loss has not been de-embedded.

Measured Performance

Bias Conditions: $V_d = 6\text{ V}$, $I_{dq} = 600\text{ mA}$

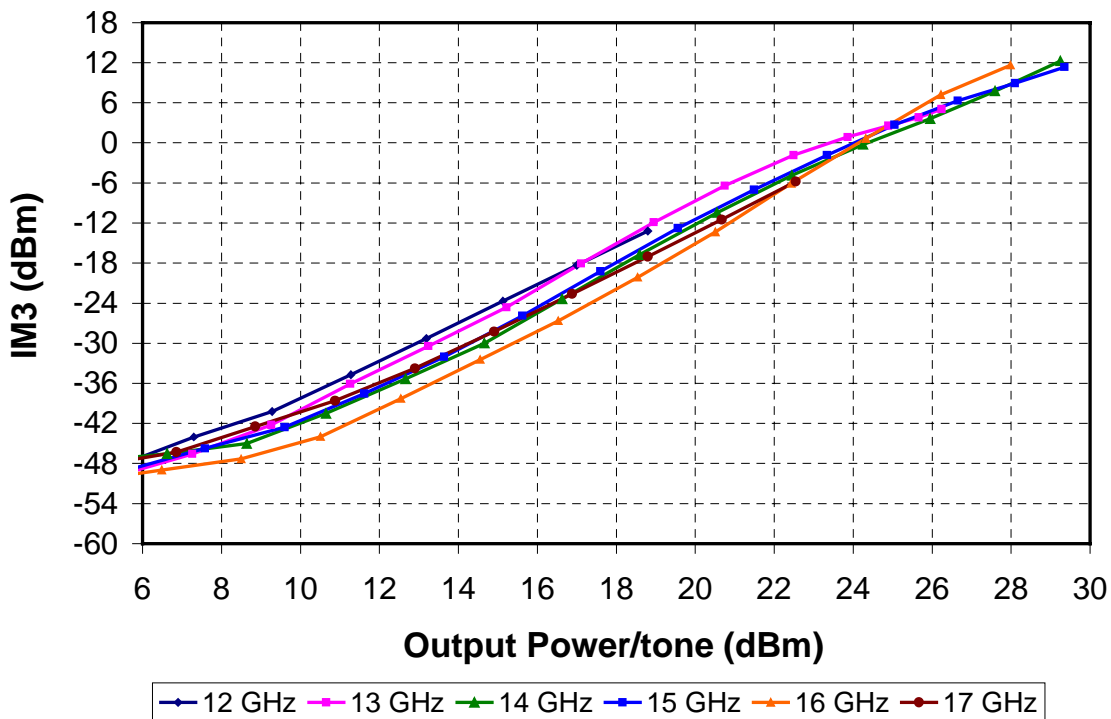
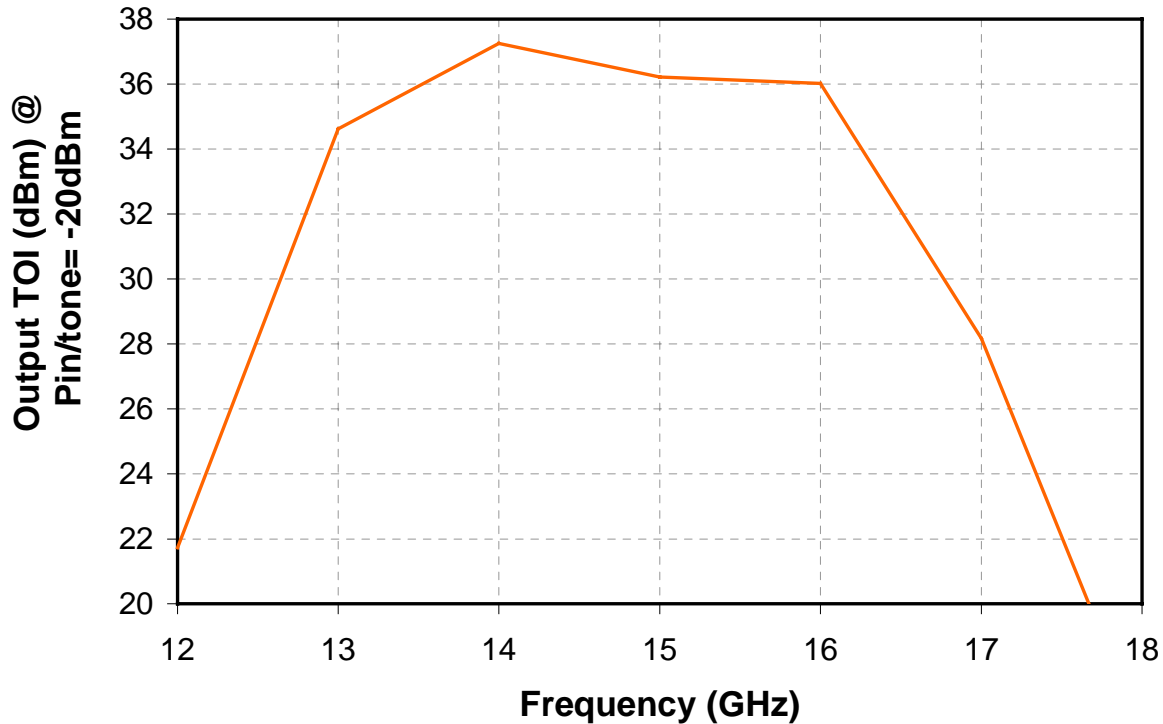

* Note:

All measured data is taken using connectorized evaluation boards. The reference plane is at RF connectors, and hence connector and board loss has not been de-embedded.

Package Pinout Diagram

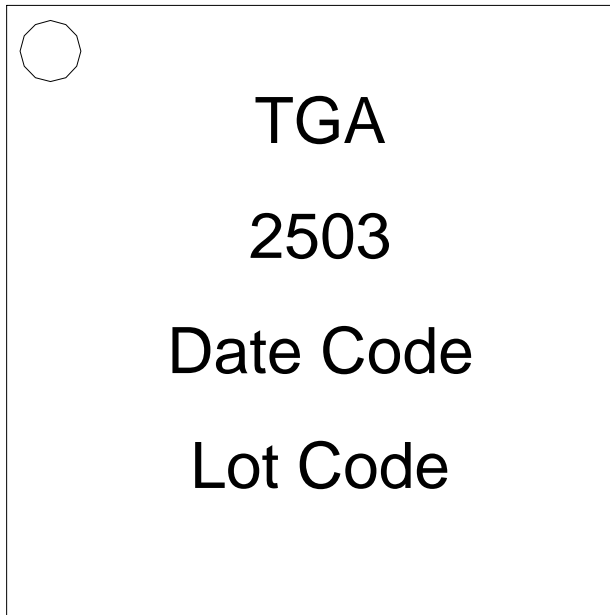

Top View

Dot indicates Pin 1

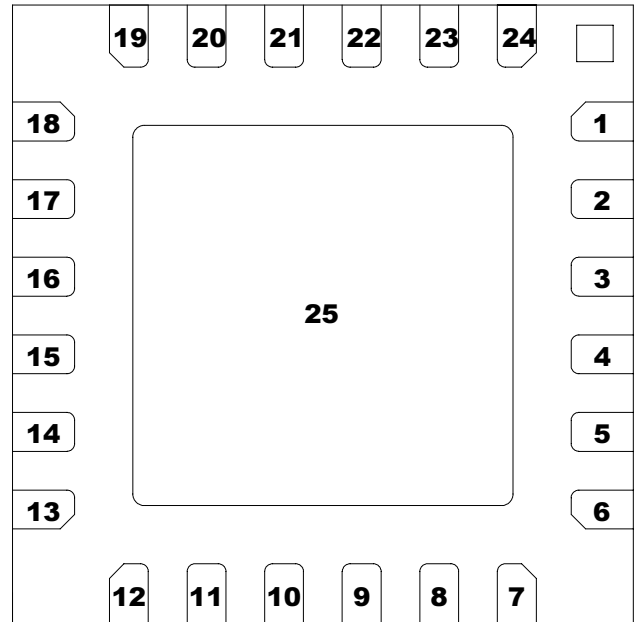

Bottom View

Pin	Description
1, 2, 4, 5, 6, 7, 9, 11, 13, 14, 15, 17, 18, 20, 22, 24	N/C
3	RF Input
8	Vg1
10	Vg2
12	Power Ref
16	RF Output
19	Vd2
21	Vd1
23	Ref
25	Gnd

Mechanical Drawing

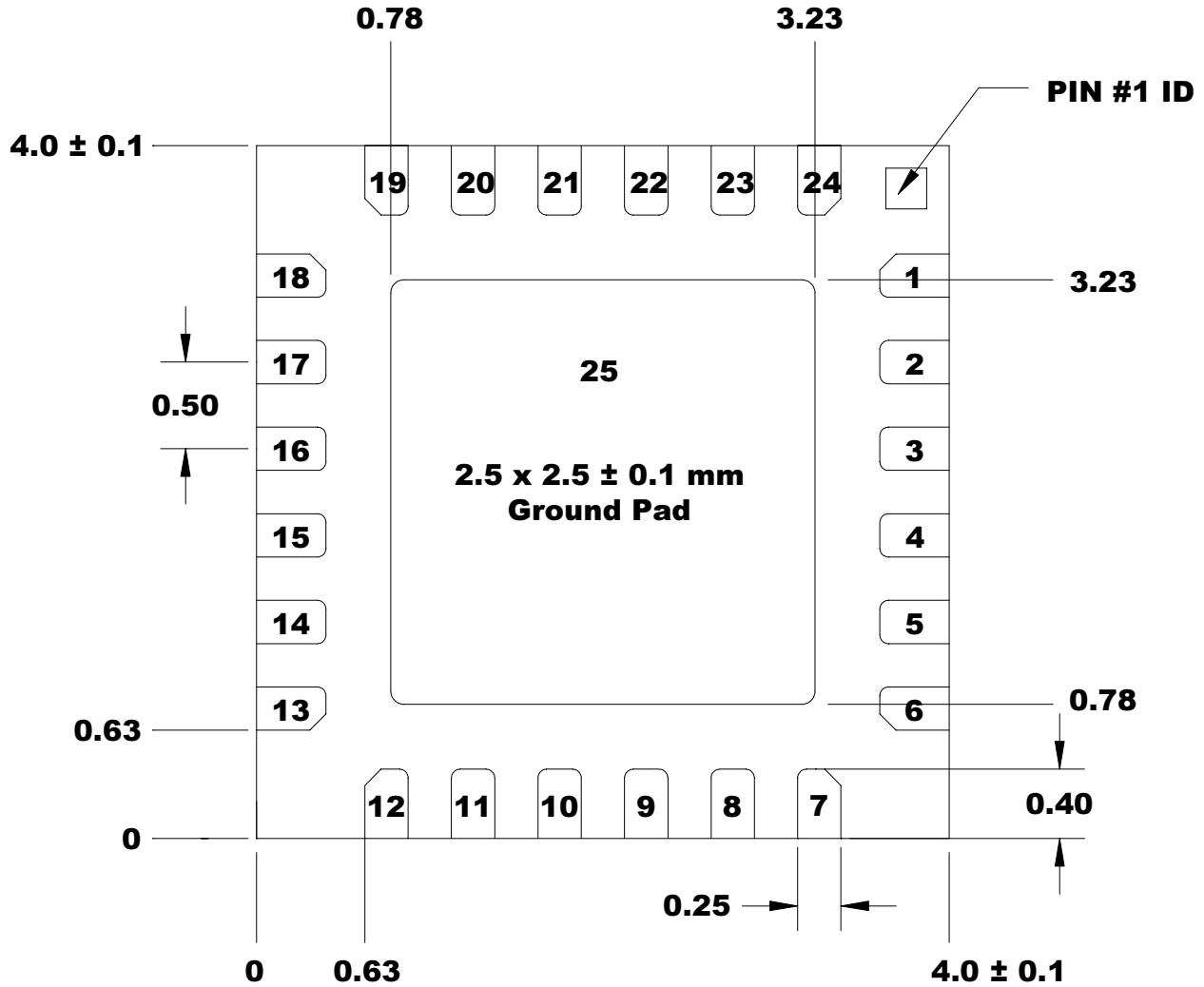

Bottom View
Tolerance: +/- 0.05
Units: mm

GaAs MMIC devices are susceptible to damage from Electrostatic Discharge. Proper precautions should be observed during handling, assembly and test.

Recommended Board Layout Assembly *

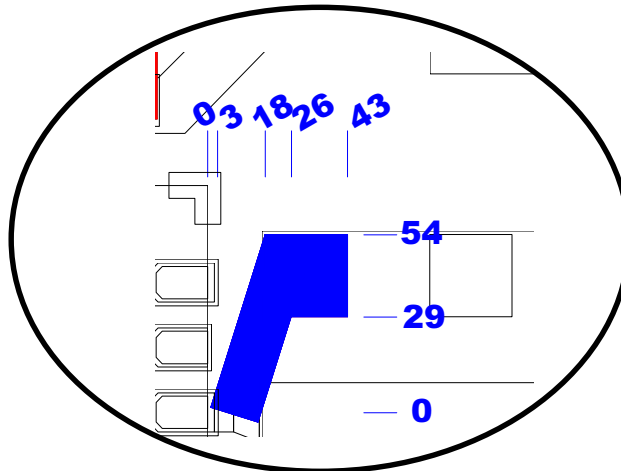
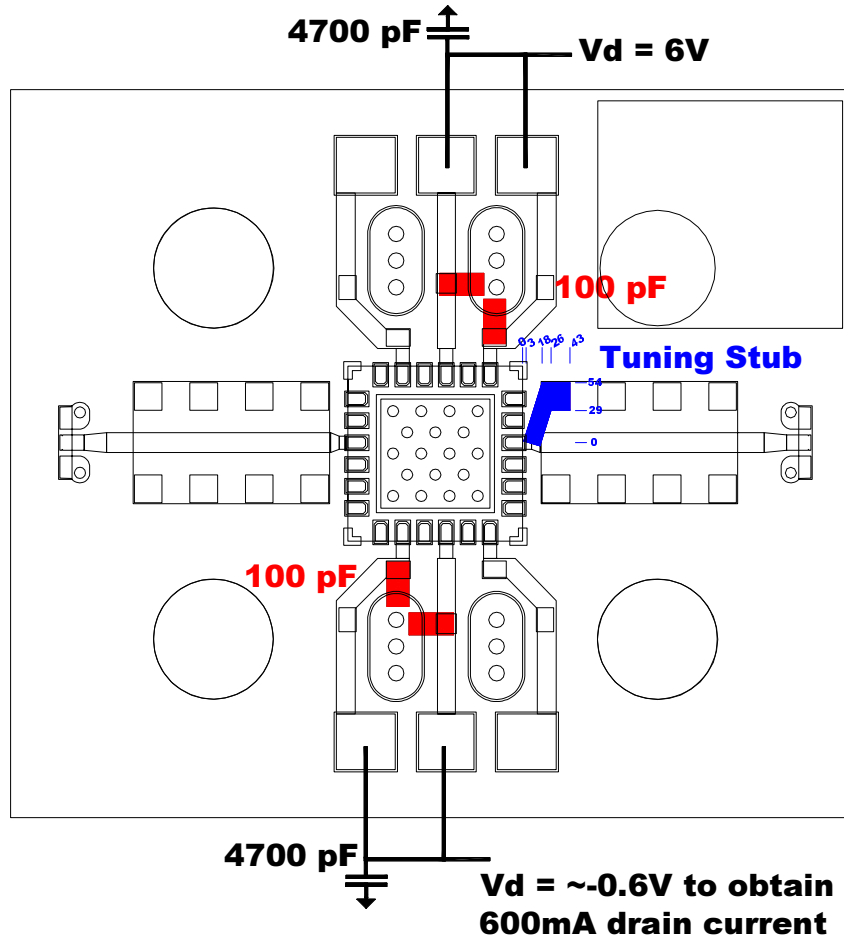

Units: mils

* This layout shows the tuning configuration used to obtain the measured data. The layout configuration may vary depending on the specific application.

PCB is RO4003 8 mil thickness, 0.5 oz standard copper cladding, with Er = 3.38.

GaAs MMIC devices are susceptible to damage from Electrostatic Discharge. Proper precautions should be observed during handling, assembly and test.

Recommended Surface Mount Package Assembly

Proper ESD precautions must be followed while handling packages.

Clean the board with acetone. Rinse with alcohol. Allow the circuit to fully dry.

TriQuint recommends using a conductive solder paste for attachment. Follow solder paste and reflow oven vendors' recommendations when developing a solder reflow profile. Typical solder reflow profiles are listed in the table below.

Hand soldering is not recommended. Solder paste can be applied using a stencil printer or dot placement. The volume of solder paste depends on PCB and component layout and should be well controlled to ensure consistent mechanical and electrical performance.

Clean the assembly with alcohol.

Typical Solder Reflow Profiles

Reflow Profile	SnPb	Pb Free
Ramp-up Rate	3 °C/sec	3 °C/sec
Activation Time and Temperature	60 – 120 sec @ 140 – 160 °C	60 – 180 sec @ 150 – 200 °C
Time above Melting Point	60 – 150 sec	60 – 150 sec
Max Peak Temperature	240 °C	260 °C
Time within 5 °C of Peak Temperature	10 – 20 sec	10 – 20 sec
Ramp-down Rate	4 – 6 °C/sec	4 – 6 °C/sec

Ordering Information

Part	Package Style
TGA2503-SM	QFN 24L 4x4 Surface Mount

GaAs MMIC devices are susceptible to damage from Electrostatic Discharge. Proper precautions should be observed during handling, assembly and test.