

Agilent HLMP-40xx, HLMP-08xx T-1 3/4, 2 mm x 5 mm Rectangular Bicolor LED Lamps

Data Sheet



Features

- Two color operation
- Three leads with one common cathode
- Option of straight or spread leads configuration
- Diffused, wide visibility range

Description

The T-1 3/4 HLMP-40xx and 2 mm by 5 mm rectangular HLMP-08xx are three leaved bicolor light sources designed for a variety of applications where dual state illumination is required in the same package. There are two LED chips, mounted on a central common cathode lead for maximum on-axis viewability. Colors between the two chips can be generated by independently pulse width modulating the LED chips.

Selection Guide

Package	Part Number	Color	Min. Luminous Intensity I _v (mcd)			I _F (mA)
			Green	Red	Yellow	
T-1 3/4	HLMP-4000	Green/HER	4.2	2.1		10
	HLMP-4000#xxx		4.2	2.1		10
	HLMP-4015	Green/Yellow	20.0		20	20
Rectangular	HLMP-0800	Green/HER	2.6	2.1		20
	HLMP-0805	Green/Yellow	2.6		1.4	20



Part Numbering System

HLMP - X X X X # X X X

Mechanical Options

- 002: Tape & Reel, Straight Leads
- 010: Right Angle Housing, Even Leads

Color Options

- 00: High Efficiency Red (HER) / High Efficiency Green
- 05/15: Yellow / High Efficiency Green

Package Options

- 40: T-1 3/4 (5 mm)
- 08: Rectangular

Package Dimensions

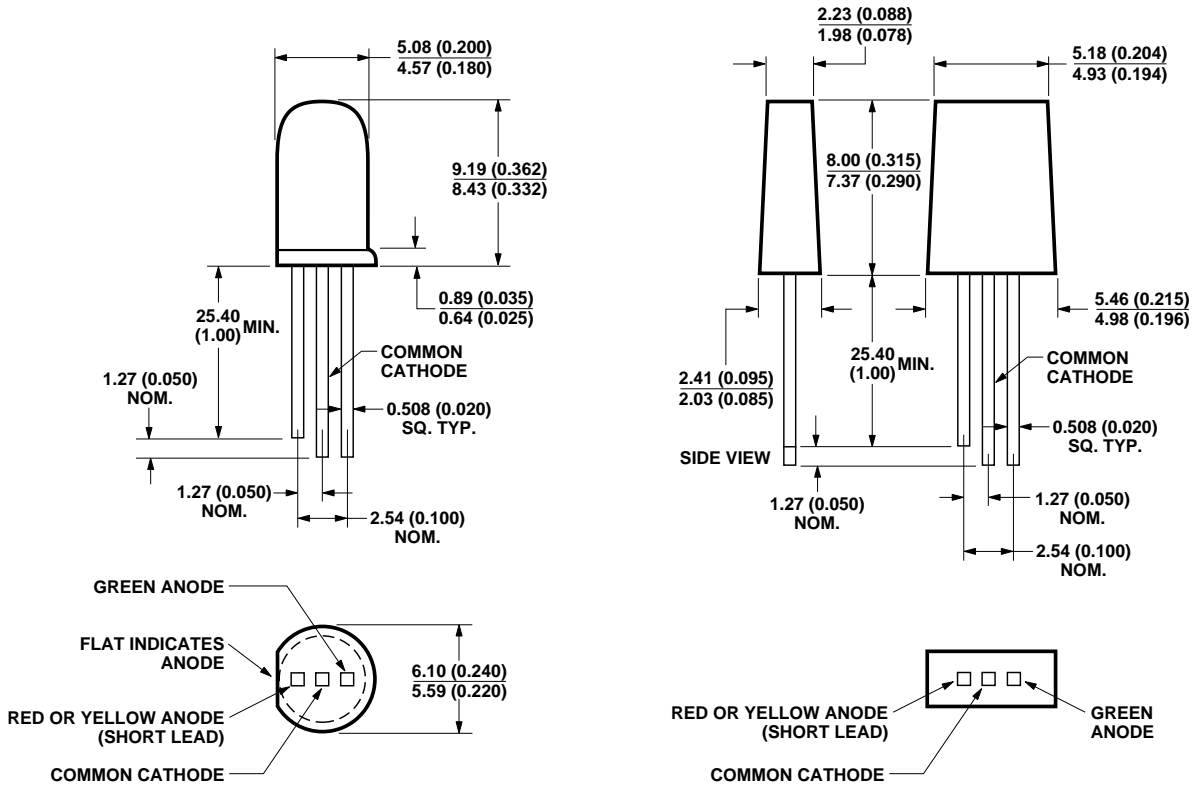

HLMP-40xx Straight Leads

HLMP-08xx Straight Leads

Notes:

- 1. All dimensions are in millimeters (inches).
- 2. Epoxy meniscus may extend about 1 mm (0.040") down the leads.

Absolute Maximum Ratings at $T_A = 25^\circ\text{C}$

Parameter	HER/Green	Yellow/Green	Units
Peak Forward Current	90	60	mA
Average Forward Current ^[1,2] (Total)	25	20	mA
DC Current ^[2] (Total)	30	20	mA
Power Dissipation ^[3] (Total)	135	135	mW
Operating Temperature Range	-20 to +100	-20 to +100	$^\circ\text{C}$
Storage Temperature Range	-55 to +100	-55 to +100	$^\circ\text{C}$
Reverse Voltage ($I_R = 100 \mu\text{A}$)	5	5	V
Transient Forward Current ^[4] (10 μsec Pulse)	500	500	mA
Solder Dipping Temperature (1.6 mm (0.063 inch) below seating plane)		260 for 5 seconds	$^\circ\text{C}$

Notes:

- See Figure 5 to establish pulsed operating conditions.
- The combined simultaneous current must not exceed the maximum.
- The combined simultaneous current must not exceed the maximum.
- The transient peak current is the maximum non-recurring current that can be applied to the device without damaging the LED die and wirebond. It is not recommended that the device be operated at peak currents beyond the peak forward current listed in the Absolute Maximum Ratings.

Electrical/Optical Characteristics at $T_A = 25^\circ\text{C}$

Symbol	Parameter	High Efficiency Red			Green			Yellow			Units	Test Condition
		Min.	Typ.	Max.	Min.	Typ.	Max.	Min.	Typ.	Max.		
λ_{PEAK}	Peak Wavelength		635			568			583		nm	20 mA
λ_d	Dominant Wavelength ^[1]		626			570			585		nm	20 mA
τ_s	Speed of Response		90			260			90		ns	
C	Capacitance		11			18			15		pF	$V_F = 0$, $f = 1 \text{ MHz}$
V_F	Forward Voltage		1.9	2.6		2.2	3.0		2.1	2.6	V	20 mA
V_R	Reverse Voltage	5			5				5		V	$I_R = 100 \mu\text{A}$
$R\theta_{\text{J-PIN}}$	Thermal Resistance		210			210			210		$^\circ\text{C/W}$	Junction-to-Cathode Lead
$2\theta_{1/2}$	Included Angle between half luminous intensity points ^[2] HLMP-40xx HLMP-08xx		65 100			65 100			65 100		degree	
η_v	Luminous Efficacy ^[3]		145			595			500		lm/W	

Notes:

- The dominant wavelength, λ_d , is derived from the CIE Chromaticity Diagram and represents the single wavelength which defines the color of the device.
- $\theta_{1/2}$ is the off-axis angle at which the luminous intensity is half the axial luminous intensity.
- Radiant intensity, I_e , in watts steradian, may be found from the equation $I_e = I_v/\eta_v$, where I_v is the luminous intensity in candelas and η_v is the luminous efficacy in lumens/watt.

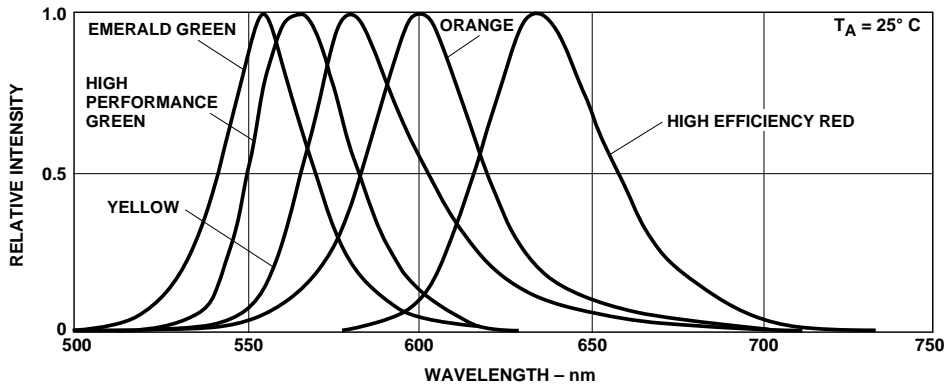

Figure 1. Relative intensity vs. wavelength.

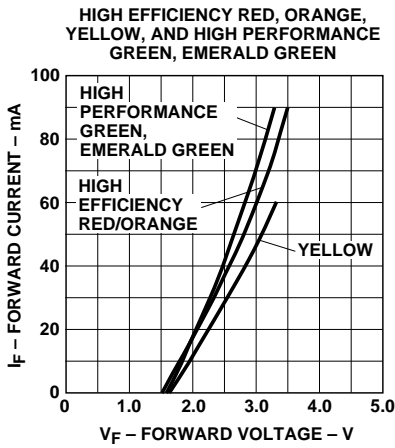

Figure 2. Forward current vs. forward voltage characteristics.

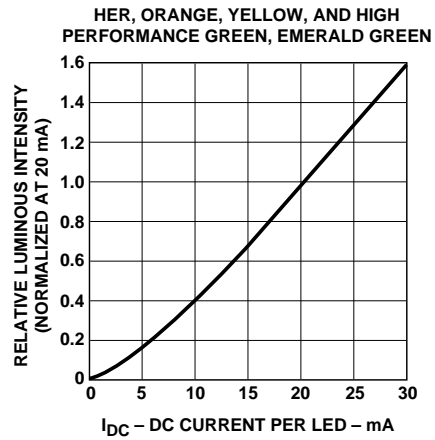

Figure 3. Relative luminous intensity vs. DC forward current.

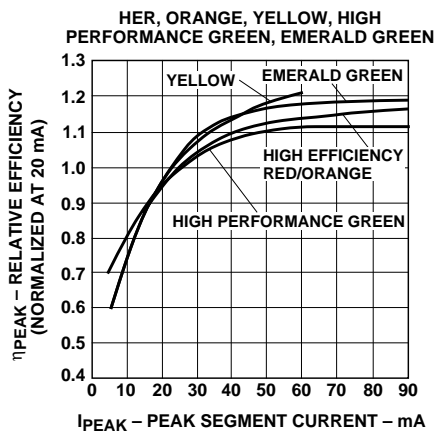

Figure 4. Relative efficiency (luminous intensity per unit current) vs. peak LED current.

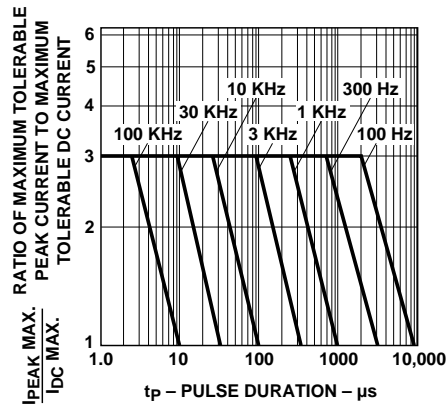

Figure 5. Maximum tolerable peak current vs. pulse duration. (I_{DC} Max. as per maximum ratings.)

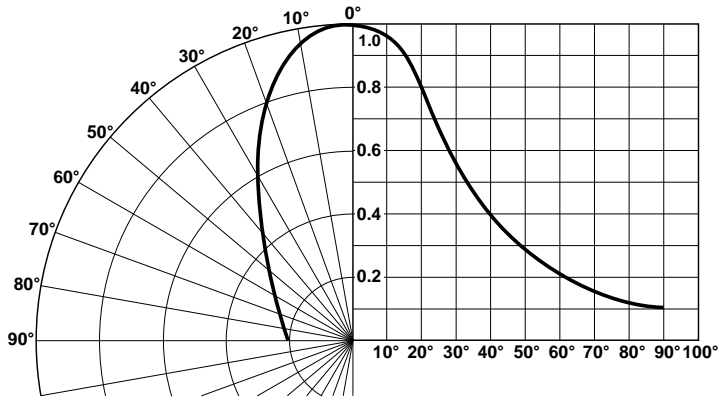

Figure 6. Relative luminous intensity vs. angular displacement for HLMP-40xx.

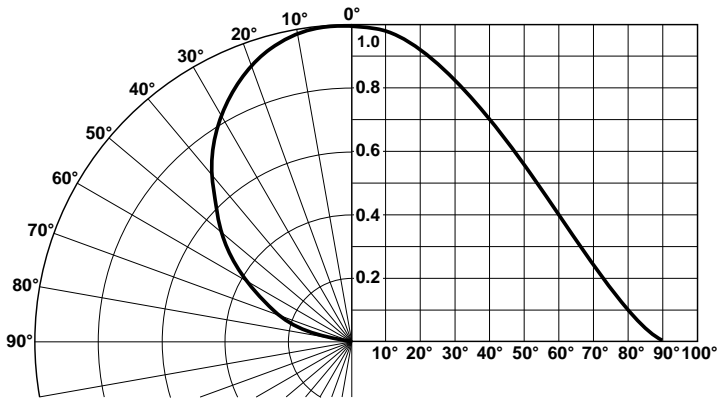

Figure 7. Relative luminous intensity vs. angular displacement for HLMP-08xx.

Mechanical Option Matrix

Mechanical Option Code	Definition
002	Tape & Reel, straight leads, minimum increment 1300 pcs/bag
010	Right Angle Housing, even leads, minimum increment 500 pcs/bag

Note:

All categories are established for classification of products. Products may not be available in all categories. Please contact your local Agilent representative for further clarification/information.

www.agilent.com/semiconductors

For product information and a complete list of distributors, please go to our web site.

For technical assistance call:

Americas/Canada: +1 (800) 235-0312 or
(916) 788-6763

Europe: +49 (0) 6441 92460

China: 10800 650 0017

Hong Kong: (+65) 6756 2394

India, Australia, New Zealand: (+65) 6755 1939

Japan: (+81 3) 3335-8152 (Domestic/International), or 0120-61-1280 (Domestic Only)

Korea: (+65) 6755 1989

Singapore, Malaysia, Vietnam, Thailand,
Philippines, Indonesia: (+65) 6755 2044

Taiwan: (+65) 6755 1843

Data subject to change.

Copyright © 2003 Agilent Technologies, Inc.

Obsoletes 5988-3775EN

May 30, 2003

5988-9672EN



Agilent Technologies