



Features

- Radial Leaded Devices
- Cured, flame retardant epoxy polymer insulating material meets UL 94V-0 requirements
- RoHS compliant*
- Agency recognition:   

Applications

Almost anywhere there is a low voltage power supply and a load to be protected, including:

- Computers & peripherals
- General electronics
- Automotive applications

MF-R Series - PTC Resettable Fuses

Electrical Characteristics

Model	V max. Volts	I max. Amps	I _{hold}	I _{trip}	Initial Resistance		1 Hour (R ₁) Post-Trip Resistance	Max. Time To Trip		Tripped Power Dissipation
			Amperes at 23 °C		Ohms at 23 °C		Ohms at 23 °C	Amperes at 23 °C	Seconds at 23 °C	Watts at 23 °C
			Hold	Trip	Min.	Max.	Max.			Typ.
MF-R005	60	40	0.05	0.10	7.3	11.1	22.0	0.5	5.0	0.22
MF-R010	60	40	0.10	0.20	2.50	4.50	7.50	0.5	4.0	0.38
MF-R017	60	40	0.17	0.34	2.00	3.20	8.00	0.85	3.0	0.48
MF-R020	60	40	0.20	0.40	1.50	2.84	4.40	1.0	2.2	0.40
MF-R025	60	40	0.25	0.50	1.00	1.95	3.00	1.25	2.5	0.45
MF-R030	60	40	0.30	0.60	0.76	1.36	2.10	1.5	3.0	0.50
MF-R040	60	40	0.40	0.80	0.52	0.86	1.29	2.0	3.8	0.55
MF-R050	60	40	0.50	1.00	0.41	0.77	1.17	2.5	4.0	0.75
MF-R065	60	40	0.65	1.30	0.27	0.48	0.72	3.25	5.3	0.90
MF-R075	60	40	0.75	1.50	0.18	0.40	0.60	3.75	6.3	0.90
MF-R090	60	40	0.90	1.80	0.14	0.31	0.47	4.5	7.2	1.00
MF-R090-0-9	30	40	0.90	1.80	0.07	0.12	0.22	4.5	5.9	0.60
MF-R110	30	40	1.10	2.20	0.10	0.18	0.27	5.5	6.6	0.70
MF-R135	30	40	1.35	2.70	0.065	0.115	0.17	6.75	7.3	0.80
MF-R160	30	40	1.60	3.20	0.055	0.105	0.15	8.0	8.0	0.90
MF-R185	30	40	1.85	3.70	0.040	0.07	0.11	9.25	8.7	1.00
MF-R250	30	40	2.50	5.00	0.025	0.048	0.07	12.5	10.3	1.20
MF-R250-0-10	30	40	2.50	5.00	0.025	0.048	0.07	12.5	10.3	1.20
MF-R300	30	40	3.00	6.00	0.020	0.05	0.08	15.0	10.8	2.00
MF-R400	30	40	4.00	8.00	0.010	0.03	0.05	20.0	12.7	2.50
MF-R500	30	40	5.00	10.00	0.010	0.03	0.05	25.0	14.5	3.00
MF-R600	30	40	6.00	12.00	0.005	0.02	0.04	30.0	16.0	3.50
MF-R700	30	40	7.00	14.00	0.005	0.02	0.03	35.0	17.5	3.80
MF-R800	30	40	8.00	16.00	0.005	0.02	0.03	40.0	18.8	4.00
MF-R900	30	40	9.00	18.00	0.005	0.01	0.02	45.0	*20.0	4.20
MF-R1100	16	100	11.00	22.00	0.003	0.01	0.014	40.0	20.0	4.50

*Tested at 40 amps

Environmental Characteristics

Operating/Storage Temperature	-40 °C to +85 °C
Maximum Device Surface Temperature in Tripped State	125 °C
Passive Aging	+85 °C, 1000 hours ±5 % typical resistance change
Humidity Aging	+85 °C, 85 % R.H. 1000 hours ±5 % typical resistance change
Thermal Shock	-40 °C to +85 °C, 10 times ±10 % typical resistance change
Solvent Resistance	MIL-STD-202, Method 215 No change
Vibration	MIL-STD-883C, Method 2007.1, Condition A No change

Test Procedures And Requirements For Model MF-R Series

Test	Test Conditions	Accept/Reject Criteria
Visual/Mech.	Verify dimensions and materials	Per MF physical description
Resistance	In still air @ 23 °C	R _{min} ≤ R ≤ R _{max}
Time to Trip	.5 times I _{hold} , V _{max} , 23 °C	T ≤ max. time to trip (seconds)
Hold Current	.30 min. at I _{hold}	No trip
Trip Cycle Life	V _{max} , I _{max} , 100 cycles	No arcing or burning
Trip Endurance	V _{max} , 48 hours	No arcing or burning

UL File NumberE 174545S
 CSA File NumberCA 110338
 TÜV File NumberR2057213

Additional Features

- Bulk packaging, tape and reel and Ammo-Pak available on most models
- Patents pending

MF-R Series - PTC Resettable Fuses

BOURNS®

Product Dimensions (see next page for outline drawing)

Model	A Max.	B Max.	C		D Min.	E Max.	Physical Characteristics		
			Nom.	Tol. ±			Style	Lead Dia.	Material
MF-R005	$\frac{8.0}{(0.315)}$	$\frac{8.3}{(0.327)}$	$\frac{5.1}{(0.201)}$	$\frac{0.7}{(0.028)}$	$\frac{7.6}{(0.299)}$	$\frac{3.1}{(0.122)}$	4	$\frac{0.405}{(0.016)}$	Sn/NiCu
MF-R010	$\frac{7.4}{(0.291)}$	$\frac{12.7}{(0.5)}$	$\frac{5.1}{(0.201)}$	$\frac{0.7}{(0.028)}$	$\frac{7.6}{(0.299)}$	$\frac{3.1}{(0.122)}$	1	$\frac{0.51}{(0.020)}$	Sn/NiCu
MF-R017	$\frac{7.4}{(0.291)}$	$\frac{12.7}{(0.5)}$	$\frac{5.1}{(0.201)}$	$\frac{0.7}{(0.028)}$	$\frac{7.6}{(0.299)}$	$\frac{3.1}{(0.122)}$	1	$\frac{0.51}{(0.020)}$	Sn/CuFe
MF-R020	$\frac{7.4}{(0.291)}$	$\frac{12.7}{(0.5)}$	$\frac{5.1}{(0.201)}$	$\frac{0.7}{(0.028)}$	$\frac{7.6}{(0.299)}$	$\frac{3.1}{(0.122)}$	1	$\frac{0.51}{(0.020)}$	Sn/CuFe
MF-R025	$\frac{7.4}{(0.291)}$	$\frac{12.7}{(0.5)}$	$\frac{5.1}{(0.201)}$	$\frac{0.7}{(0.028)}$	$\frac{7.6}{(0.299)}$	$\frac{3.1}{(0.122)}$	1	$\frac{0.51}{(0.020)}$	Sn/CuFe
MF-R030	$\frac{7.4}{(0.291)}$	$\frac{13.4}{(0.528)}$	$\frac{5.1}{(0.201)}$	$\frac{0.7}{(0.028)}$	$\frac{7.6}{(0.299)}$	$\frac{3.1}{(0.122)}$	1	$\frac{0.51}{(0.020)}$	Sn/CuFe
MF-R040	$\frac{7.4}{(0.291)}$	$\frac{13.7}{(0.539)}$	$\frac{5.1}{(0.201)}$	$\frac{0.7}{(0.028)}$	$\frac{7.6}{(0.299)}$	$\frac{3.1}{(0.122)}$	1	$\frac{0.51}{(0.020)}$	Sn/CuFe
MF-R050	$\frac{7.9}{(0.311)}$	$\frac{13.7}{(0.539)}$	$\frac{5.1}{(0.201)}$	$\frac{0.7}{(0.028)}$	$\frac{7.6}{(0.299)}$	$\frac{3.1}{(0.122)}$	1	$\frac{0.51}{(0.020)}$	Sn/Cu
MF-R065	$\frac{9.7}{(0.382)}$	$\frac{15.2}{(0.598)}$	$\frac{5.1}{(0.201)}$	$\frac{0.7}{(0.028)}$	$\frac{7.6}{(0.299)}$	$\frac{3.1}{(0.122)}$	1	$\frac{0.51}{(0.020)}$	Sn/Cu
MF-R075	$\frac{10.4}{(0.409)}$	$\frac{16.0}{(0.630)}$	$\frac{5.1}{(0.201)}$	$\frac{0.7}{(0.028)}$	$\frac{7.6}{(0.299)}$	$\frac{3.1}{(0.122)}$	1	$\frac{0.51}{(0.020)}$	Sn/Cu
MF-R090	$\frac{11.7}{(0.461)}$	$\frac{16.7}{(0.657)}$	$\frac{5.1}{(0.201)}$	$\frac{0.7}{(0.028)}$	$\frac{7.6}{(0.299)}$	$\frac{3.1}{(0.122)}$	1	$\frac{0.51}{(0.020)}$	Sn/Cu
MF-R090-0-9	$\frac{7.4}{(0.291)}$	$\frac{12.2}{(0.480)}$	$\frac{5.1}{(0.201)}$	$\frac{0.7}{(0.028)}$	$\frac{7.6}{(0.299)}$	$\frac{3.0}{(0.118)}$	3	$\frac{0.51}{(0.020)}$	Sn/CuFe
MF-R110	$\frac{8.9}{(0.350)}$	$\frac{14.0}{(0.551)}$	$\frac{5.1}{(0.201)}$	$\frac{0.7}{(0.028)}$	$\frac{7.6}{(0.299)}$	$\frac{3.0}{(0.118)}$	1	$\frac{0.51}{(0.020)}$	Sn/Cu
MF-R135	$\frac{8.9}{(0.350)}$	$\frac{18.9}{(0.744)}$	$\frac{5.1}{(0.201)}$	$\frac{0.7}{(0.028)}$	$\frac{7.6}{(0.299)}$	$\frac{3.0}{(0.118)}$	1	$\frac{0.51}{(0.020)}$	Sn/Cu
MF-R160	$\frac{10.2}{(0.402)}$	$\frac{16.8}{(0.661)}$	$\frac{5.1}{(0.201)}$	$\frac{0.7}{(0.028)}$	$\frac{7.6}{(0.299)}$	$\frac{3.0}{(0.118)}$	1	$\frac{0.51}{(0.020)}$	Sn/Cu
MF-R185	$\frac{12.0}{(0.472)}$	$\frac{18.4}{(0.724)}$	$\frac{5.1}{(0.201)}$	$\frac{0.7}{(0.028)}$	$\frac{7.6}{(0.299)}$	$\frac{3.0}{(0.118)}$	1	$\frac{0.51}{(0.020)}$	Sn/Cu
MF-R250	$\frac{12.0}{(0.472)}$	$\frac{18.3}{(0.720)}$	$\frac{5.1}{(0.201)}$	$\frac{0.7}{(0.028)}$	$\frac{7.6}{(0.299)}$	$\frac{3.0}{(0.118)}$	2	$\frac{0.81}{(0.032)}$	Sn/Cu
MF-R250-0-10	$\frac{12.0}{(0.472)}$	$\frac{18.3}{(0.720)}$	$\frac{5.1}{(0.201)}$	$\frac{0.7}{(0.028)}$	$\frac{7.6}{(0.299)}$	$\frac{3.0}{(0.118)}$	3	$\frac{0.51}{(0.020)}$	Sn/CuFe
MF-R300	$\frac{12.0}{(0.472)}$	$\frac{18.3}{(0.720)}$	$\frac{5.1}{(0.201)}$	$\frac{0.7}{(0.028)}$	$\frac{7.6}{(0.299)}$	$\frac{3.0}{(0.118)}$	2	$\frac{0.81}{(0.032)}$	Sn/Cu
MF-R400	$\frac{14.4}{(0.567)}$	$\frac{24.8}{(0.976)}$	$\frac{5.1}{(0.201)}$	$\frac{0.7}{(0.028)}$	$\frac{7.6}{(0.299)}$	$\frac{3.0}{(0.118)}$	2	$\frac{0.81}{(0.032)}$	Sn/Cu
MF-R500	$\frac{17.4}{(0.685)}$	$\frac{24.9}{(0.980)}$	$\frac{10.2}{(0.402)}$	$\frac{0.7}{(0.028)}$	$\frac{7.6}{(0.299)}$	$\frac{3.0}{(0.118)}$	2	$\frac{0.81}{(0.032)}$	Sn/Cu
MF-R600	$\frac{19.3}{(0.760)}$	$\frac{31.9}{(1.256)}$	$\frac{10.2}{(0.402)}$	$\frac{0.7}{(0.028)}$	$\frac{7.6}{(0.299)}$	$\frac{3.0}{(0.118)}$	2	$\frac{0.81}{(0.032)}$	Sn/Cu
MF-R700	$\frac{22.1}{(0.870)}$	$\frac{29.8}{(1.173)}$	$\frac{10.2}{(0.402)}$	$\frac{0.7}{(0.028)}$	$\frac{7.6}{(0.299)}$	$\frac{3.0}{(0.118)}$	2	$\frac{0.81}{(0.032)}$	Sn/Cu
MF-R800	$\frac{24.2}{(0.953)}$	$\frac{32.9}{(1.295)}$	$\frac{10.2}{(0.402)}$	$\frac{0.7}{(0.028)}$	$\frac{7.6}{(0.299)}$	$\frac{3.0}{(0.118)}$	2	$\frac{0.81}{(0.032)}$	Sn/Cu
MF-R900	$\frac{24.2}{(0.953)}$	$\frac{32.9}{(1.295)}$	$\frac{10.2}{(0.402)}$	$\frac{0.7}{(0.028)}$	$\frac{7.6}{(0.299)}$	$\frac{3.0}{(0.118)}$	2	$\frac{0.81}{(0.032)}$	Sn/Cu
MF-R1100	$\frac{24.2}{(0.953)}$	$\frac{32.9}{(1.295)}$	$\frac{10.2}{(0.402)}$	$\frac{0.7}{(0.028)}$	$\frac{7.6}{(0.299)}$	$\frac{3.0}{(0.118)}$	2	$\frac{0.81}{(0.032)}$	Sn/Cu

Packaging options: BULK: All models = 500 pcs. per bag.
 TAPE & REEL: MF-R005-MF-R160 - 12.7 mm device pitch = 3000 pcs. per reel;
 MF-R185-MF-R400 - 25.4mm device pitch = 1500 pcs. per reel; MF-R090-0-9 & MF-R250-0-10 = 1500 pcs. per reel.
 AMMO-PACK: MF-R005-MF-R160 - 12.7 mm device pitch = 2000 pcs. per reel;
 MF-R185-MF-R400 - 25.4 mm device pitch = 1000 pcs. per reel; MF-R090-0-9 & MF-R250-0-10 = 2000 pcs. per reel.

DIMENSIONS = $\frac{\text{MM}}{\text{(INCHES)}}$
 0.405 (26AWG)
 0.51 (24AWG)
 0.81 (20AWG)

Specifications are subject to change without notice.
 Customers should verify actual device performance in their specific applications.

MF-R Series - PTC Resettable Fuses

BOURNS®

Product Dimensions (see previous page for dimensions)

Style 1

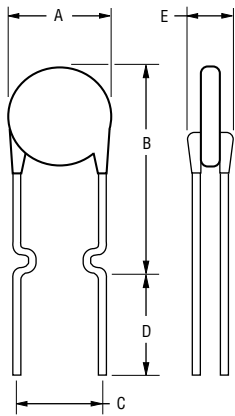

Style 2

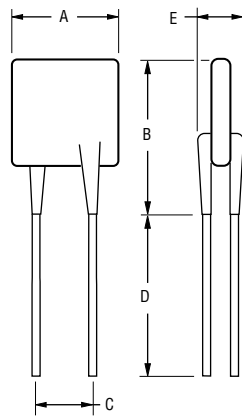

Style 3

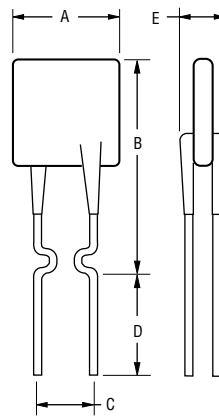

Style 4

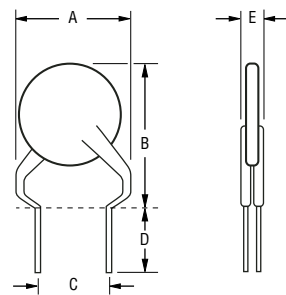

NOTE: Kinked lead option is available for board standoff. Contact factory for details.

NOTE: Also available with straight leads. Contact factory for details.

Thermal Derating Chart - I_{hold} / I_{trip} (Amps)

Model	Ambient Operating Temperature								
	-40 °C	-20 °C	0 °C	23 °C	40 °C	50 °C	60 °C	70 °C	85 °C
MF-R005	0.08 / 0.16	0.07 / 0.14	0.06 / 0.12	0.05 / 0.10	0.04 / 0.08	0.04 / 0.08	0.03 / 0.07	0.03 / 0.07	0.02 / 0.05
MF-R010	0.16 / 0.32	0.14 / 0.28	0.12 / 0.24	0.10 / 0.20	0.08 / 0.16	0.07 / 0.14	0.06 / 0.12	0.05 / 0.10	0.04 / 0.08
MF-R017	0.26 / 0.52	0.23 / 0.46	0.20 / 0.40	0.17 / 0.34	0.14 / 0.28	0.12 / 0.24	0.11 / 0.22	0.09 / 0.18	0.07 / 0.14
MF-R020	0.31 / 0.62	0.27 / 0.54	0.24 / 0.48	0.20 / 0.40	0.16 / 0.32	0.14 / 0.28	0.13 / 0.26	0.11 / 0.22	0.08 / 0.16
MF-R025	0.39 / 0.78	0.34 / 0.68	0.30 / 0.60	0.25 / 0.50	0.20 / 0.40	0.18 / 0.36	0.16 / 0.32	0.14 / 0.28	0.10 / 0.20
MF-R030	0.47 / 0.94	0.41 / 0.82	0.36 / 0.72	0.30 / 0.60	0.24 / 0.48	0.22 / 0.44	0.19 / 0.38	0.16 / 0.32	0.12 / 0.24
MF-R040	0.62 / 1.24	0.54 / 1.08	0.48 / 0.96	0.40 / 0.80	0.32 / 0.64	0.29 / 0.58	0.25 / 0.50	0.22 / 0.44	0.16 / 0.32
MF-R050	0.78 / 1.56	0.68 / 1.36	0.60 / 1.20	0.50 / 1.00	0.41 / 0.82	0.36 / 0.72	0.32 / 0.64	0.27 / 0.54	0.20 / 0.40
MF-R065	1.01 / 2.02	0.88 / 1.76	0.77 / 1.54	0.65 / 1.30	0.53 / 1.06	0.47 / 0.94	0.41 / 0.82	0.35 / 0.70	0.26 / 0.52
MF-R075	1.16 / 2.32	1.02 / 2.04	0.89 / 1.78	0.75 / 1.50	0.61 / 1.22	0.54 / 1.08	0.47 / 0.94	0.41 / 0.82	0.30 / 0.60
MF-R090	1.40 / 2.80	1.22 / 2.44	1.07 / 2.14	0.90 / 1.80	0.73 / 1.46	0.65 / 1.30	0.57 / 1.14	0.49 / 0.98	0.36 / 0.72
MF-R090-0-9	1.40 / 2.80	1.22 / 2.44	1.07 / 2.14	0.90 / 1.80	0.73 / 1.46	0.65 / 1.30	0.57 / 1.14	0.49 / 0.98	0.36 / 0.72
MF-R110	1.60 / 3.20	1.43 / 2.86	1.27 / 2.54	1.10 / 2.20	0.91 / 1.82	0.85 / 1.70	0.75 / 1.50	0.67 / 1.34	0.57 / 1.14
MF-R135	1.96 / 3.92	1.76 / 3.52	1.55 / 3.10	1.35 / 2.70	1.12 / 2.24	1.04 / 2.08	0.92 / 1.84	0.82 / 1.64	0.70 / 1.40
MF-R160	2.32 / 4.64	2.08 / 4.16	1.84 / 3.68	1.60 / 3.20	1.33 / 2.66	1.23 / 2.46	1.09 / 2.18	0.98 / 1.96	0.83 / 1.66
MF-R185	2.68 / 5.36	2.41 / 4.82	2.13 / 4.26	1.85 / 3.70	1.54 / 3.08	1.42 / 2.84	1.26 / 2.52	1.13 / 2.26	0.96 / 1.92
MF-R250	3.63 / 7.26	3.25 / 6.50	2.88 / 5.76	2.50 / 5.00	2.08 / 4.16	1.93 / 3.86	1.70 / 3.40	1.53 / 3.06	1.30 / 2.60
MF-R250-0-10	3.63 / 7.26	3.25 / 6.50	2.88 / 5.76	2.50 / 5.00	2.08 / 4.16	1.93 / 3.86	1.70 / 3.40	1.53 / 3.06	1.30 / 2.60
MF-R300	4.35 / 8.70	3.90 / 7.80	3.45 / 6.90	3.00 / 6.00	2.49 / 4.98	2.31 / 4.62	2.04 / 4.08	1.83 / 3.66	1.56 / 3.12
MF-R400	5.80 / 11.6	5.20 / 10.4	4.60 / 9.20	4.00 / 8.00	3.32 / 6.64	3.08 / 6.16	2.72 / 5.44	2.44 / 4.88	2.08 / 4.16
MF-R500	7.25 / 14.5	6.50 / 13.0	5.75 / 11.5	5.00 / 10.0	4.15 / 8.30	3.85 / 7.70	3.40 / 6.80	3.05 / 6.10	2.60 / 5.20
MF-R600	8.70 / 17.4	7.80 / 15.6	6.90 / 13.8	6.00 / 12.0	4.98 / 9.96	4.62 / 9.24	4.08 / 8.16	3.66 / 7.32	3.12 / 6.24
MF-R700	10.1 / 20.3	9.10 / 18.2	8.05 / 16.1	7.00 / 14.0	5.81 / 11.6	5.39 / 10.7	4.76 / 9.52	4.27 / 9.44	3.64 / 7.28
MF-R800	11.6 / 23.2	10.4 / 20.8	9.20 / 18.4	8.00 / 16.0	6.64 / 13.2	6.16 / 12.3	5.44 / 10.8	4.88 / 9.76	4.16 / 8.32
MF-R900	13.0 / 26.1	11.7 / 23.4	10.3 / 20.7	9.00 / 18.0	7.47 / 14.9	6.93 / 12.7	6.12 / 12.2	5.49 / 10.9	4.68 / 9.36
MF-R1100	16.1 / 32.0	14.6 / 29.2	13.1 / 26.2	11.0 / 22.1	9.40 / 18.4	8.80 / 17.6	7.80 / 15.6	6.90 / 13.8	5.20 / 10.4

Specifications are subject to change without notice. Customers should verify actual device performance in their specific applications.

MF-R Series - PTC Resettable Fuses

BOURNS®

Typical Time to Trip at 23 °C

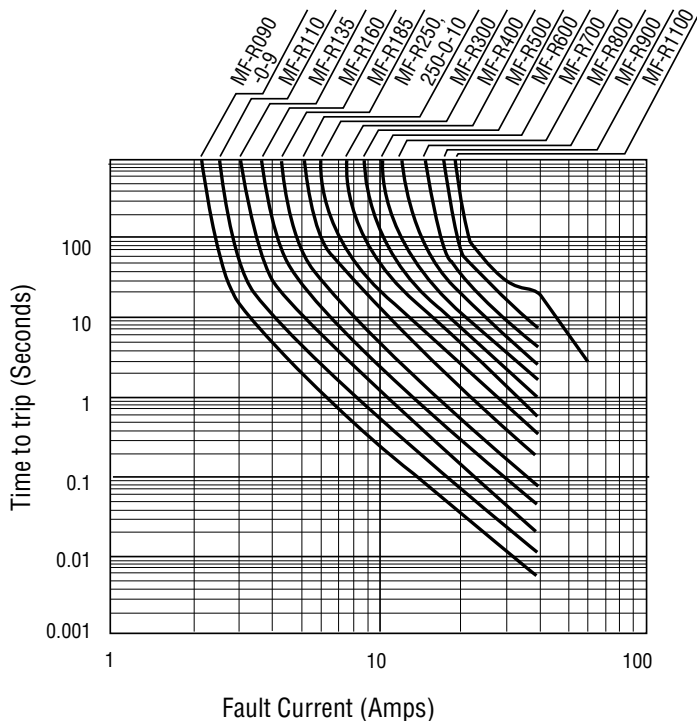
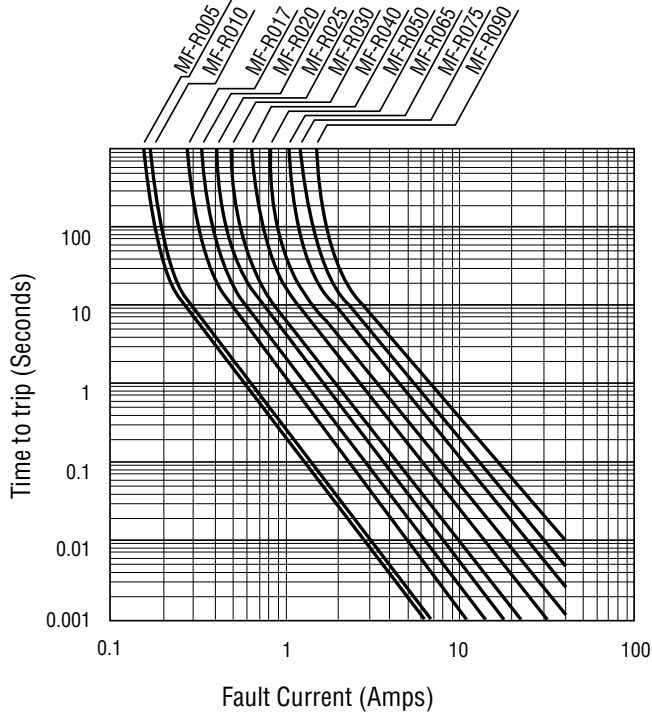

How to Order

MF - R 110 - 0 - 99

Multifuse®
 Product Designator _____
 Series _____
 R = Radial Leaded Component
 Hold Current, I_{hold} _____
 005-1100 (0.05 Amps - 11.0 Amps)
 Packaging Options _____
 - ____ = Bulk Packaging without part number suffix option
 - 0-99 = Bulk Packaging with part number suffix option
 - 2 = Tape and Reel without part number suffix option*
 - 2-99 = Tape and Reel with part number suffix option
 - AP = Ammo-Pak*
 - 0-14 = Kinked leads where straight leads are standard
 - 0-17 = Straight leads where kinked leads are standard
 Part Number Suffix Option _____
 - 99 = As of date code April 1, 2005 all MF-R models are RoHS compliant. The suffix "-99" can be used if a new part number is required to reference the RoHS compliance.

Examples:
 MF-R110Bulk packaging
 MF-R110-0-99Bulk packaging with part number suffix option
 MF-R110-2Tape and reel packaging
 MF-R110-2-99Tape and reel packaging with part number suffix option
 MF-R090-0-9-99Bulk packaging with part number suffix option
 MF-R250-0-10-99 ..Bulk packaging with part number suffix option

*Packaged per EIA486-B

Typical Part Marking: MF-R005 - R025

Represents total content. Layout may vary.

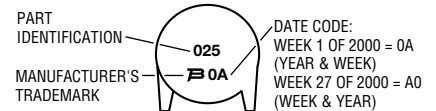

Typical Part Marking: MF-R030 - R1100

Represents total content. Layout may vary.

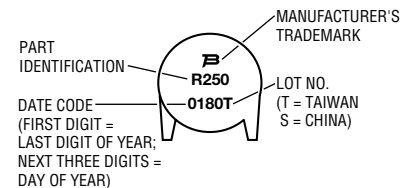

MF-R SERIES, REV. U, 02/06

**MF-R, MF-RX, MF-R/90, MF-RX/72 & MF-RX/250 Series
Tape and Reel Specifications**

BOURNS®

Devices taped using EIA468-B/IEC286-2 standards. See table below and Figures 1 and 2 for details.

Dimension Description	IEC Mark	EIA Mark	Dimensions	
			Dimensions	Tolerance
Carrier tape width	W	W	$\frac{18}{(.709)}$	$\frac{-0.5/+1.0}{(-0.02/+0.039)}$
Hold down tape width: all others	W_0	W_4	$\frac{11}{(.433)}$	min.
Hold down tape			No protrusion	
Top distance between tape edges	W_2	W_6	$\frac{3}{(.118)}$	max.
Sprocket hole position	W_1	W_5	$\frac{9}{(.354)}$	$\frac{-0.5/+0.75}{(-0.02/+0.03)}$
Sprocket hole diameter	D_0	D_0	$\frac{4}{(.157)}$	$\frac{\pm 0.2}{(\pm .0078)}$
Abscissa to plane (straight lead)	H	H	$\frac{18.5}{(.728)}$	$\frac{\pm 3.0}{(\pm .118)}$
Abscissa to plane (kinked lead)	H_0	H_0	$\frac{16}{(.63)}$	$\frac{\pm 0.5}{(\pm .02)}$
Abscissa to top (straight lead)	H_1	H_1	$\frac{38.0}{(1.496)}$	max.
Abscissa to top (kinked lead)	H_1	H_1	$\frac{32.2}{(1.268)}$	max.
Overall width w/lead protrusion (straight lead)		C_1	$\frac{55.0}{(2.165)}$	max.
Overall width w/lead protrusion (kinked lead)		C_1	$\frac{43.2}{(1.7)}$	max.
Overall width w/o lead protrusion (straight lead)		C_2	$\frac{54.0}{(2.126)}$	max.
Overall width w/o lead protrusion (kinked lead)		C_2	$\frac{42.5}{(1.673)}$	max.
Lead protrusion	l_1	L_1	$\frac{1.0}{(.039)}$	max.
Protrusion of cutout	L	L	$\frac{11}{(.433)}$	max.
Protrusion beyond hold tape	l_2	l_2	Not specified	
Sprocket hole pitch	P_0	P_0	$\frac{12.7}{(0.5)}$	$\frac{\pm 0.3}{(\pm .012)}$
Pitch tolerance			20 consecutive	± 1
Device pitch: MF-R005–MF-R160, MF-R/90 & MF-RX/72			$\frac{12.7}{(0.5)}$	
Device pitch: MF-R185–MF-R400, MF-RX110–MF-RX375			$\frac{25.4}{(1.0)}$	
Tape thickness	t	t	$\frac{0.9}{(.035)}$	max.
Tape thickness with splice: MF-R010–MF-R160		t_1	$\frac{1.5}{(.059)}$	max.
Tape thickness with splice: MF-R250–MF-R1100 MF-RX110–MF-RX375 & MF-R/90		t_1	$\frac{2.3}{(.091)}$	max.
Splice sprocket hole alignment			0	$\frac{\pm 0.3}{(\pm .012)}$
Body lateral deviation	Δh	Δh	0	$\frac{\pm 1.0}{(\pm .039)}$
Body tape plane deviation	Δp	Δp	0	$\frac{\pm 0.3}{(\pm .021)}$
Lead spacing	F	F	$\frac{5.08}{(0.2)}$	$\frac{\pm 0.2}{(\pm .008)}$
Reel width	w	W_2	$\frac{56}{(2.205)}$	max.
Reel diameter	d	a	$\frac{370}{(14.57)}$	max.
Space between flanges less device	W_1	h	$\frac{4.75}{(.187)}$	$\frac{\pm 3.25}{(\pm .128)}$

Specifications are subject to change without notice.
Customers should verify actual device performance in their specific applications.

DIMENSIONS = $\frac{\text{MM}}{\text{(INCHES)}}$

**MF-R, MF-RX, MF-R/90, MF-RX/72 & MF-RX/250 Series
Tape and Reel Specifications**



Dimension Description	IEC Mark	EIA Mark	Dimensions	
			Dimensions	Tolerance
Arbor hole diameter	<i>f</i>	<i>c</i>	$\frac{26}{(1.024)}$	$\frac{\pm 12.0}{(\pm .472)}$
Core diameter: MF-R, MF-RX, MF-R/90	<i>h</i>	<i>n</i>	$\frac{80}{(3.15)}$	max.
Box: MF-R, MF-RX, MF-R/90			$\frac{56}{(2.2)}$ $\frac{372}{(14.6)}$ $\frac{372}{(14.6)}$	max.
Consecutive missing places: MF-R, MF-RX, MF-R/90			3	max.
Empty places per reel: MF-R, MF-RX, MF-R/90			Not specified	

Taped Component Dimensions - Figure 1

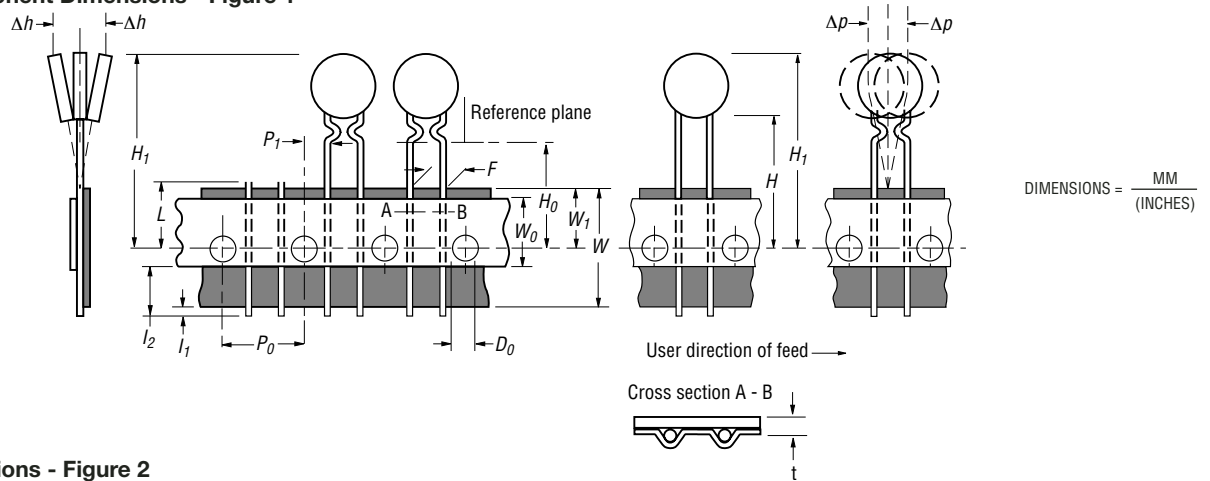

Reel Dimensions - Figure 2

