

PN2222A

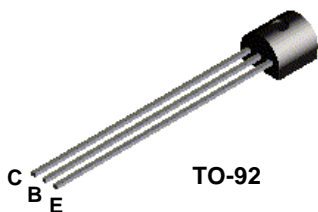

MMBT2222A

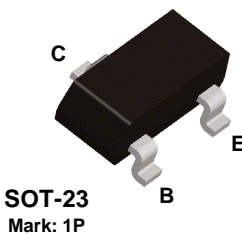

PZT2222A

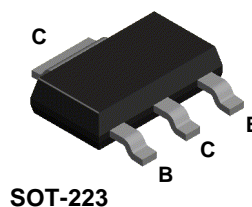

MMPQ2222

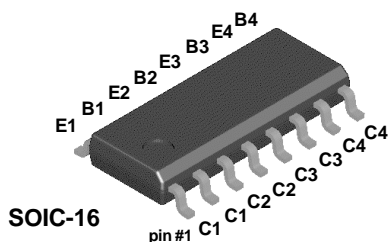

NMT2222

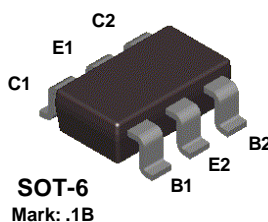

NPN General Purpose Amplifier

This device is for use as a medium power amplifier and switch requiring collector currents up to 500 mA. Sourced from Process 19.

Absolute Maximum Ratings*

TA = 25°C unless otherwise noted

Symbol	Parameter	Value	Units
V _{CEO}	Collector-Emitter Voltage	40	V
V _{CBO}	Collector-Base Voltage	75	V
V _{EBO}	Emitter-Base Voltage	6.0	V
I _C	Collector Current - Continuous	1.0	A
T _J , T _{stg}	Operating and Storage Junction Temperature Range	-55 to +150	°C

*These ratings are limiting values above which the serviceability of any semiconductor device may be impaired.

NOTES:

- 1) These ratings are based on a maximum junction temperature of 150 degrees C.
- 2) These are steady state limits. The factory should be consulted on applications involving pulsed or low duty cycle operations.

NPN General Purpose Amplifier

(continued)

Electrical Characteristics

TA = 25°C unless otherwise noted

Symbol	Parameter	Test Conditions	Min	Max	Units
OFF CHARACTERISTICS					
$V_{(BR)CEO}$	Collector-Emitter Breakdown Voltage*	$I_C = 10 \text{ mA}, I_B = 0$	40		V
$V_{(BR)CBO}$	Collector-Base Breakdown Voltage	$I_C = 10 \text{ } \mu\text{A}, I_E = 0$	75		V
$V_{(BR)EBO}$	Emitter-Base Breakdown Voltage	$I_E = 10 \text{ } \mu\text{A}, I_C = 0$	6.0		V
I_{CEX}	Collector Cutoff Current	$V_{CE} = 60 \text{ V}, V_{EB(OFF)} = 3.0 \text{ V}$		10	nA
I_{CBO}	Collector Cutoff Current	$V_{CB} = 60 \text{ V}, I_E = 0$ $V_{CB} = 60 \text{ V}, I_E = 0, T_A = 150^\circ\text{C}$		0.01 10	μA μA
I_{EBO}	Emitter Cutoff Current	$V_{EB} = 3.0 \text{ V}, I_C = 0$		10	nA
I_{BL}	Base Cutoff Current	$V_{CE} = 60 \text{ V}, V_{EB(OFF)} = 3.0 \text{ V}$		20	nA

ON CHARACTERISTICS

h_{FE}	DC Current Gain	$I_C = 0.1 \text{ mA}, V_{CE} = 10 \text{ V}$ $I_C = 1.0 \text{ mA}, V_{CE} = 10 \text{ V}$ $I_C = 10 \text{ mA}, V_{CE} = 10 \text{ V}$ $I_C = 10 \text{ mA}, V_{CE} = 10 \text{ V}, T_A = -55^\circ\text{C}$ $I_C = 150 \text{ mA}, V_{CE} = 10 \text{ V}^*$ $I_C = 150 \text{ mA}, V_{CE} = 1.0 \text{ V}^*$ $I_C = 500 \text{ mA}, V_{CE} = 10 \text{ V}^*$	35 50 75 35 100 50 40	300	
$V_{CE(sat)}$	Collector-Emitter Saturation Voltage*	$I_C = 150 \text{ mA}, I_B = 15 \text{ mA}$ $I_C = 500 \text{ mA}, I_B = 50 \text{ mA}$		0.3 1.0	V V
$V_{BE(sat)}$	Base-Emitter Saturation Voltage*	$I_C = 150 \text{ mA}, I_B = 15 \text{ mA}$ $I_C = 500 \text{ mA}, I_B = 50 \text{ mA}$	0.6	1.2 2.0	V V

SMALL SIGNAL CHARACTERISTICS (except MMPQ2222 and NMT2222)

f_T	Current Gain - Bandwidth Product	$I_C = 20 \text{ mA}, V_{CE} = 20 \text{ V}, f = 100 \text{ MHz}$	300		MHz
C_{obo}	Output Capacitance	$V_{CB} = 10 \text{ V}, I_E = 0, f = 100 \text{ kHz}$		8.0	pF
C_{ibo}	Input Capacitance	$V_{EB} = 0.5 \text{ V}, I_C = 0, f = 100 \text{ kHz}$		25	pF
$r_b'C_C$	Collector Base Time Constant	$I_C = 20 \text{ mA}, V_{CB} = 20 \text{ V}, f = 31.8 \text{ MHz}$		150	pS
NF	Noise Figure	$I_C = 100 \text{ } \mu\text{A}, V_{CE} = 10 \text{ V},$ $R_S = 1.0 \text{ k}\Omega, f = 1.0 \text{ kHz}$		4.0	dB
$Re(h_{ie})$	Real Part of Common-Emitter High Frequency Input Impedance	$I_C = 20 \text{ mA}, V_{CE} = 20 \text{ V}, f = 300 \text{ MHz}$		60	Ω

SWITCHING CHARACTERISTICS (except MMPQ2222 and NMT2222)

t_d	Delay Time	$V_{CC} = 30 \text{ V}, V_{BE(OFF)} = 0.5 \text{ V},$		10	ns
t_r	Rise Time	$I_C = 150 \text{ mA}, I_{B1} = 15 \text{ mA}$		25	ns
t_s	Storage Time	$V_{CC} = 30 \text{ V}, I_C = 150 \text{ mA},$		225	ns
t_f	Fall Time	$I_{B1} = I_{B2} = 15 \text{ mA}$		60	ns

*Pulse Test: Pulse Width $\leq 300 \text{ } \mu\text{s}$, Duty Cycle $\leq 2.0\%$

Spice Model

NPN (Is=14.34f Xti=3 Eg=1.11 Vaf=74.03 Bf=255.9 Ne=1.307 Ise=14.34f Ikf=.2847 Xtb=1.5 Br=6.092 Nc=2 Isc=0 Ikr=0 Rc=1 Cjc=7.306p Mjc=.3416 Vjc=.75 Fc=.5 Cje=22.01p Mje=.377 Vje=.75 Tr=46.91n Tf=411.1p Itf=.6 Vtf=1.7 Xtf=3 Rb=10)

PN2222A / MMBT2222A / MMPQ2222 / NMT2222 / PZT2222A

NPN General Purpose Amplifier

(continued)

PN2222A / MMBT2222A / MM2222A / NMT2222 / PZT2222A

Thermal Characteristics

TA = 25°C unless otherwise noted

Symbol	Characteristic	Max		Units
		PN2222A	*PZT2222A	
P _D	Total Device Dissipation Derate above 25°C	625	1,000	mW
		5.0	8.0	mW/°C
R _{θJC}	Thermal Resistance, Junction to Case	83.3		°C/W
R _{θJA}	Thermal Resistance, Junction to Ambient	200	125	°C/W

Symbol	Characteristic	Max		Units
		**MMBT2222A	MMPQ2222	
P _D	Total Device Dissipation Derate above 25°C	350	1,000	mW
		2.8	8.0	mW/°C
R _{θJA}	Thermal Resistance, Junction to Ambient Effective 4 Die Each Die	357		°C/W
			125	°C/W
			240	°C/W

* Device mounted on FR-4 PCB 36 mm X 18 mm X 1.5 mm; mounting pad for the collector lead min. 6 cm².

** Device mounted on FR-4 PCB 1.6" X 1.6" X 0.06."

Typical Characteristics

Typical Pulsed Current Gain vs Collector Current

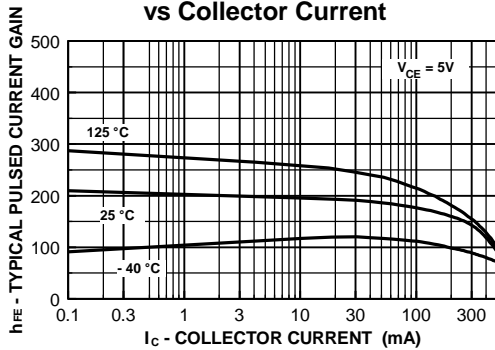

Collector-Emitter Saturation Voltage vs Collector Current

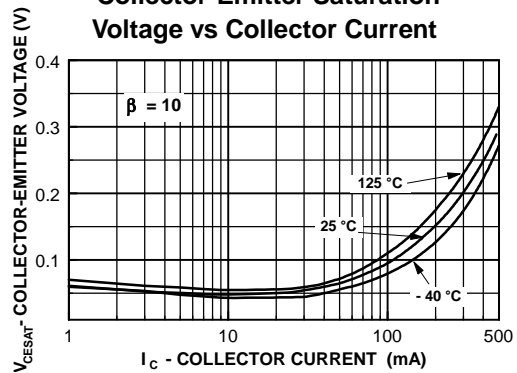

Base-Emitter Saturation Voltage vs Collector Current

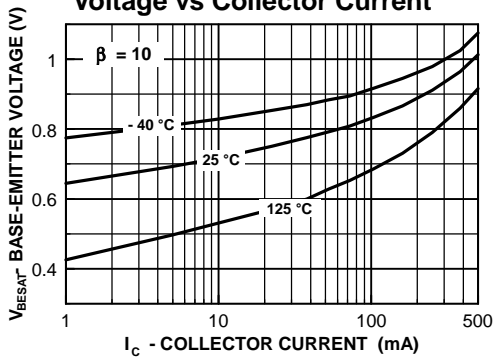

Base-Emitter ON Voltage vs Collector Current

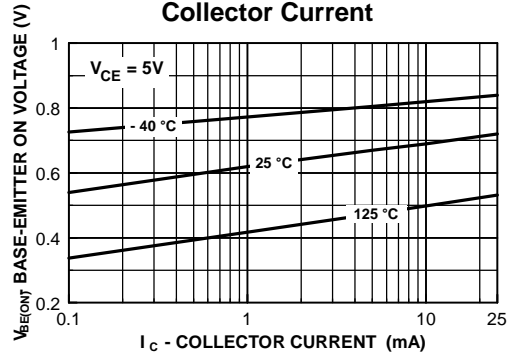

NPN General Purpose Amplifier

(continued)

PN2222A / MMBT2222A / MMIPQ2222 / NMT2222 / PZT2222A

Typical Characteristics (continued)

Collector-Cutoff Current vs Ambient Temperature

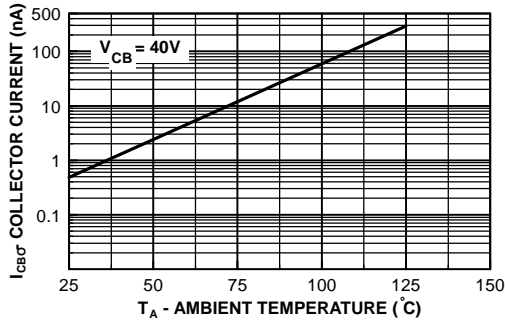

Emitter Transition and Output Capacitance vs Reverse Bias Voltage

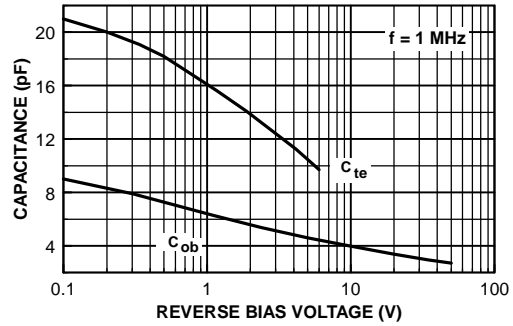

Turn On and Turn Off Times vs Collector Current

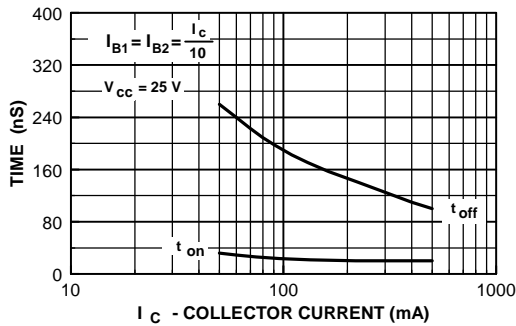

Switching Times vs Collector Current

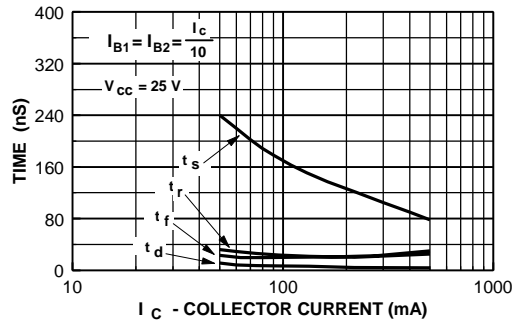

Power Dissipation vs Ambient Temperature

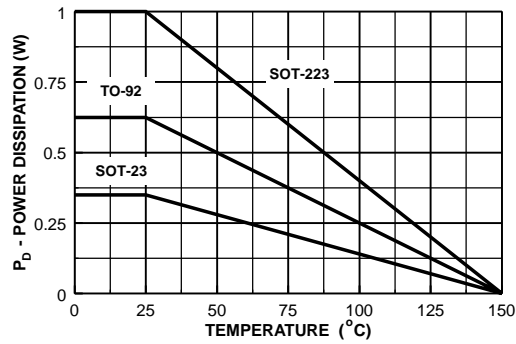

Test Circuits

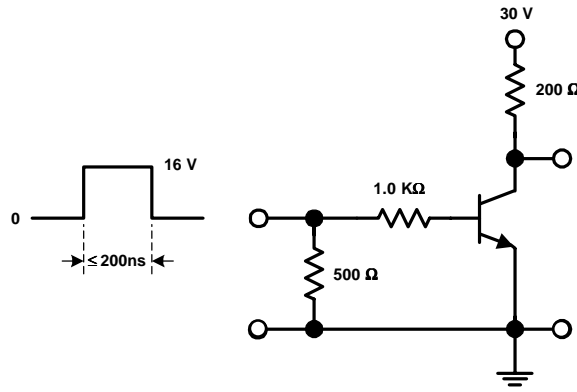

FIGURE 1: Saturated Turn-On Switching Time

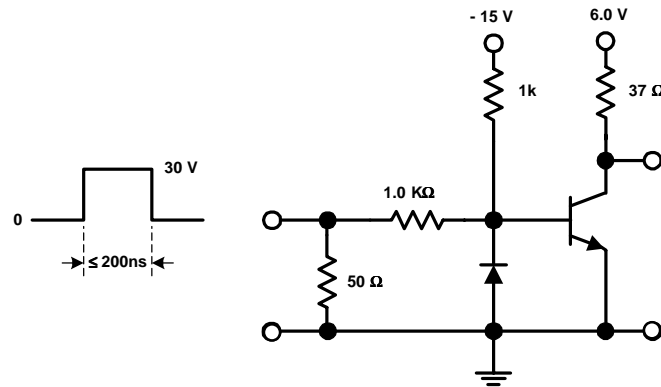

FIGURE 2: Saturated Turn-Off Switching Time

TRADEMARKS

The following are registered and unregistered trademarks Fairchild Semiconductor owns or is authorized to use and is not intended to be an exhaustive list of all such trademarks.

ACEx™	HiSeC™	SuperSOT™-8
Bottomless™	ISOPLANAR™	SyncFET™
CoolFET™	MICROWIRE™	TinyLogic™
CROSSVOLT™	POP™	UHC™
E ² CMOS™	PowerTrench®	VCX™
FACT™	QFET™	
FACT Quiet Series™	QS™	
FAST®	Quiet Series™	
FASTr™	SuperSOT™-3	
GTO™	SuperSOT™-6	

DISCLAIMER

FAIRCHILD SEMICONDUCTOR RESERVES THE RIGHT TO MAKE CHANGES WITHOUT FURTHER NOTICE TO ANY PRODUCTS HEREIN TO IMPROVE RELIABILITY, FUNCTION OR DESIGN. FAIRCHILD DOES NOT ASSUME ANY LIABILITY ARISING OUT OF THE APPLICATION OR USE OF ANY PRODUCT OR CIRCUIT DESCRIBED HEREIN; NEITHER DOES IT CONVEY ANY LICENSE UNDER ITS PATENT RIGHTS, NOR THE RIGHTS OF OTHERS.

LIFE SUPPORT POLICY

FAIRCHILD'S PRODUCTS ARE NOT AUTHORIZED FOR USE AS CRITICAL COMPONENTS IN LIFE SUPPORT DEVICES OR SYSTEMS WITHOUT THE EXPRESS WRITTEN APPROVAL OF FAIRCHILD SEMICONDUCTOR CORPORATION. As used herein:

1. Life support devices or systems are devices or systems which, (a) are intended for surgical implant into the body, or (b) support or sustain life, or (c) whose failure to perform when properly used in accordance with instructions for use provided in the labeling, can be reasonably expected to result in significant injury to the user.
2. A critical component is any component of a life support device or system whose failure to perform can be reasonably expected to cause the failure of the life support device or system, or to affect its safety or effectiveness.

PRODUCT STATUS DEFINITIONS

Definition of Terms

Datasheet Identification	Product Status	Definition
Advance Information	Formative or In Design	This datasheet contains the design specifications for product development. Specifications may change in any manner without notice.
Preliminary	First Production	This datasheet contains preliminary data, and supplementary data will be published at a later date. Fairchild Semiconductor reserves the right to make changes at any time without notice in order to improve design.
No Identification Needed	Full Production	This datasheet contains final specifications. Fairchild Semiconductor reserves the right to make changes at any time without notice in order to improve design.
Obsolete	Not In Production	This datasheet contains specifications on a product that has been discontinued by Fairchild semiconductor. The datasheet is printed for reference information only.