

**NPN Silicon Switching Transistor Array**

- High DC current gain: 0.1mA to 100mA
- Low collector-emitter saturation voltage
- Two ( galvanic) internal isolated Transistors with good matching in one package
- Complementary type: SMBT3906S (PNP)

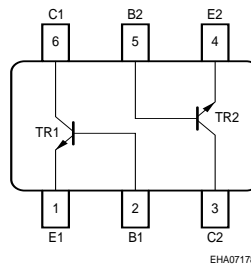
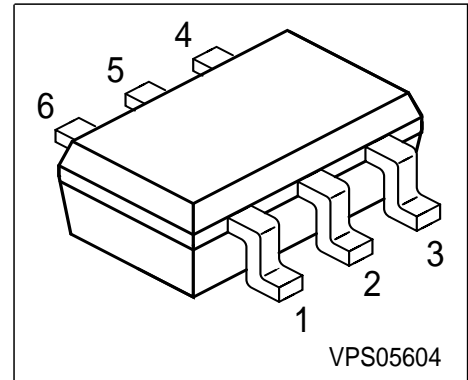

Type	Marking	Pin Configuration					Package	
SMBT3904S	s1A	1=E1	2=B1	3=C2	4=E2	5=B2	6=C1	SOT363

**Maximum Ratings**

Parameter	Symbol	Value	Unit
Collector-emitter voltage	$V_{CEO}$	40	V
Collector-base voltage	$V_{CBO}$	60	
Emitter-base voltage	$V_{EBO}$	6	
DC collector current	$I_C$	200	mA
Total power dissipation, $T_S = 115\text{ °C}$	$P_{tot}$	250	mW
Junction temperature	$T_j$	150	°C
Storage temperature	$T_{stg}$	-65 ... 150	

**Thermal Resistance**

Junction - soldering point <sup>1)</sup>	$R_{thJS}$	≤140	K/W
--	------------	------	-----

<sup>1)</sup>For calculation of  $R_{thJA}$  please refer to Application Note Thermal Resistance

**Electrical Characteristics** at  $T_A = 25^\circ\text{C}$ , unless otherwise specified.

Parameter	Symbol	Values			Unit
		min.	typ.	max.	
<b>DC Characteristics</b>					
Collector-emitter breakdown voltage $I_C = 1 \text{ mA}, I_B = 0$	$V_{(BR)CEO}$	40	-	-	V
Collector-base breakdown voltage $I_C = 10 \mu\text{A}, I_E = 0$	$V_{(BR)CBO}$	60	-	-	
Emitter-base breakdown voltage $I_E = 10 \mu\text{A}, I_C = 0$	$V_{(BR)EBO}$	6	-	-	
Collector cutoff current $V_{CB} = 30 \text{ V}, I_E = 0$	$I_{CBO}$	-	-	50	nA
DC current gain 1) $I_C = 100 \mu\text{A}, V_{CE} = 1 \text{ V}$ $I_C = 1 \text{ mA}, V_{CE} = 1 \text{ V}$ $I_C = 10 \text{ mA}, V_{CE} = 1 \text{ V}$ $I_C = 50 \text{ mA}, V_{CE} = 1 \text{ V}$ $I_C = 100 \text{ mA}, V_{CE} = 1 \text{ V}$	$h_{FE}$	40 70 100 60 30	- - - - -	- - 300 - -	-
Collector-emitter saturation voltage1) $I_C = 10 \text{ mA}, I_B = 1 \text{ mA}$ $I_C = 50 \text{ mA}, I_B = 5 \text{ mA}$	$V_{CEsat}$	- -	- -	0.2 0.3	V
Base-emitter saturation voltage 1) $I_C = 10 \text{ mA}, I_B = 1 \text{ mA}$ $I_C = 50 \text{ mA}, I_B = 5 \text{ mA}$	$V_{BEsat}$	0.65 -	- -	0.85 0.95	

 1) Pulse test:  $t < 300 \mu\text{s}$ ;  $D < 2\%$

**Electrical Characteristics** at  $T_A = 25^\circ\text{C}$ , unless otherwise specified.

Parameter	Symbol	Values			Unit
		min.	typ.	max.	
<b>AC Characteristics</b>					
Transition frequency $I_C = 10\text{ mA}, V_{CE} = 20\text{ V}, f = 100\text{ MHz}$	$f_T$	300	-	-	MHz
Collector-base capacitance $V_{CB} = 5\text{ V}, f = 1\text{ MHz}$	$C_{cb}$	-	-	4	pF
Emitter-base capacitance $V_{EB} = 0.5\text{ V}, f = 1\text{ MHz}$	$C_{eb}$	-	-	8	
Short-circuit input impedance $I_C = 1\text{ mA}, V_{CE} = 10\text{ V}, f = 1\text{ kHz}$	$h_{11e}$	1	-	10	k $\Omega$
Open-circuit reverse voltage transf.ratio $I_C = 1\text{ mA}, V_{CE} = 10\text{ V}, f = 1\text{ kHz}$	$h_{12e}$	0.5	-	8	$10^{-4}$
Short-circuit forward current transf.ratio $I_C = 1\text{ mA}, V_{CE} = 10\text{ V}, f = 1\text{ kHz}$	$h_{21e}$	100	-	400	-
Open-circuit output admittance $I_C = 1\text{ mA}, V_{CE} = 10\text{ V}, f = 1\text{ kHz}$	$h_{22e}$	1	-	40	$\mu\text{S}$
Noise figure $I_C = 100\text{ }\mu\text{A}, V_{CE} = 5\text{ V}, R_S = 1\text{ k}\Omega,$ $f = 1\text{ kHz}, \Delta f = 200\text{ Hz}$	$F$	-	-	5	dB
Delay time $V_{CC} = 3\text{ V}, I_C = 10\text{ mA}, I_{B1} = 1\text{ mA},$ $V_{BE(\text{off})} = 0.5\text{ V}$	$t_d$	-	-	35	ns
Rise time $V_{CC} = 3\text{ V}, I_C = 10\text{ mA}, I_{B1} = 1\text{ mA},$ $V_{BE(\text{off})} = 0.5\text{ V}$	$t_r$	-	-	35	
Storage time $V_{CC} = 3\text{ V}, I_C = 10\text{ mA}, I_{B1}=I_{B2} = 1\text{ mA}$	$t_{stg}$	-	-	200	
Fall time $V_{CC} = 3\text{ V}, I_C = 10\text{ mA}, I_{B1}=I_{B2} = 1\text{ mA}$	$t_f$	-	-	50	

**Test circuit**

**Delay and rise time**

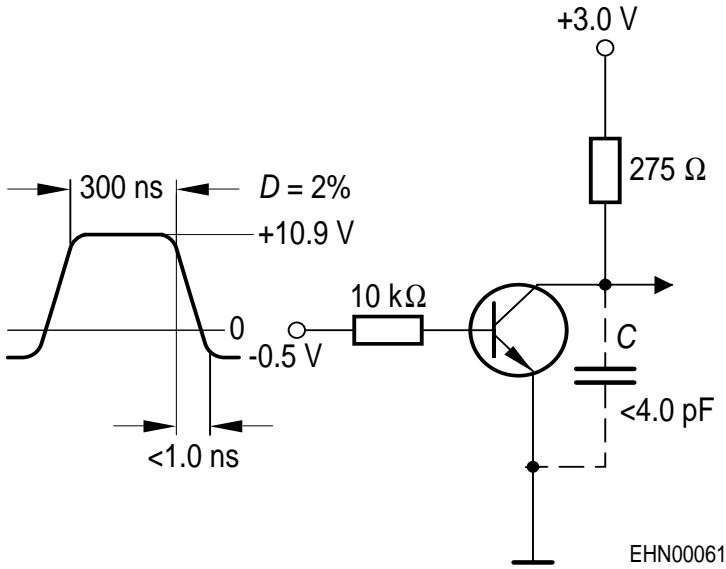

**Storage time and fall time**

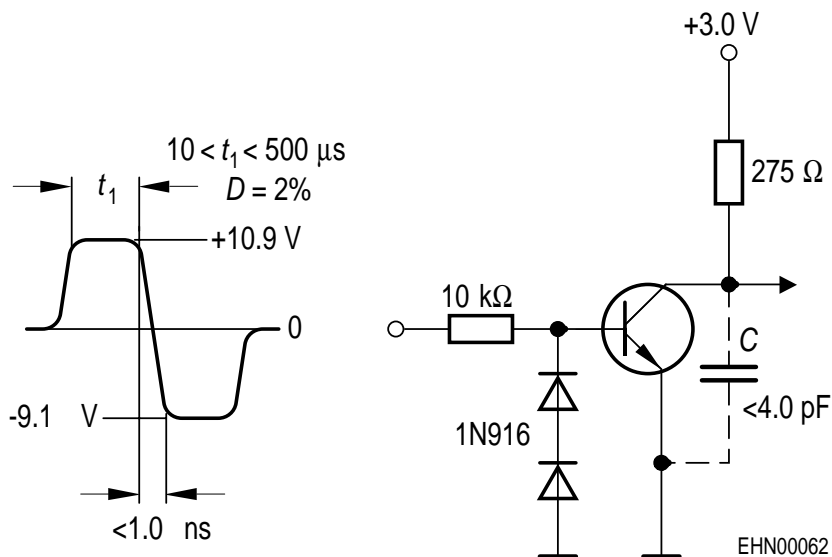

**Total power dissipation  $P_{tot} = f(T_S)$**

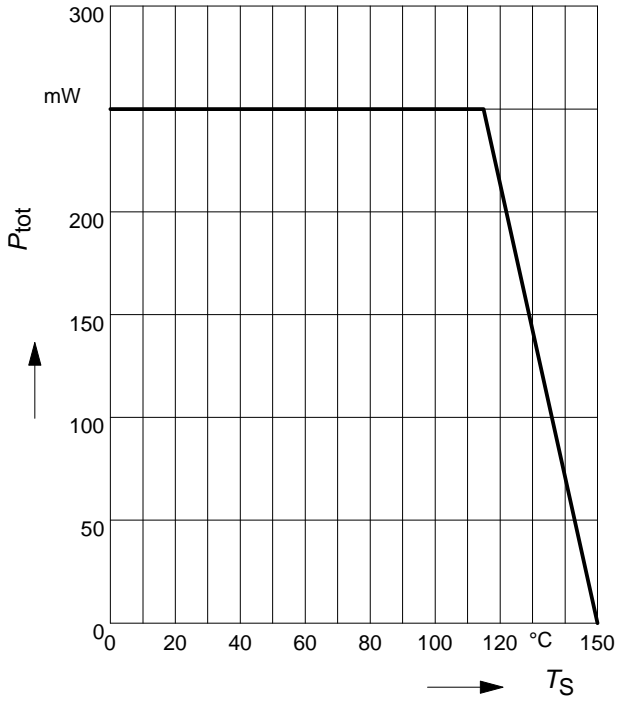

**Permissible Pulse Load  $R_{thJS} = f(t_p)$**

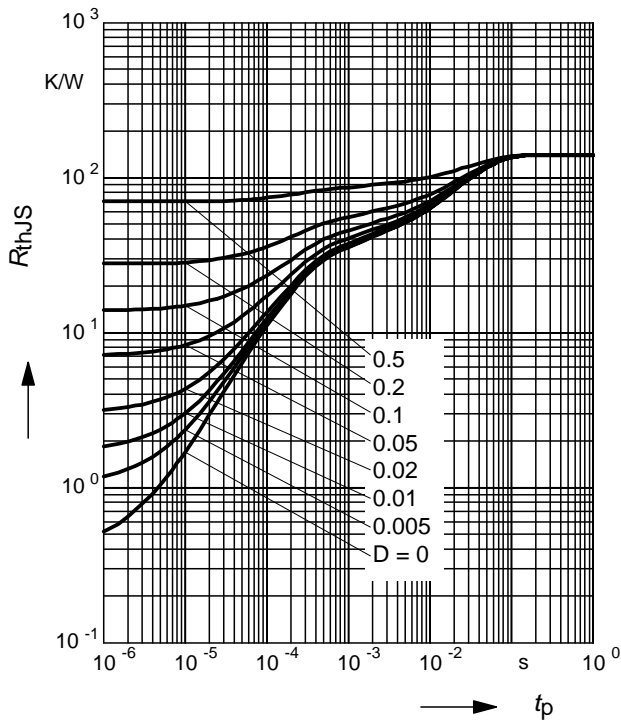

**Permissible Pulse Load**

$P_{totmax} / P_{totDC} = f(t_p)$

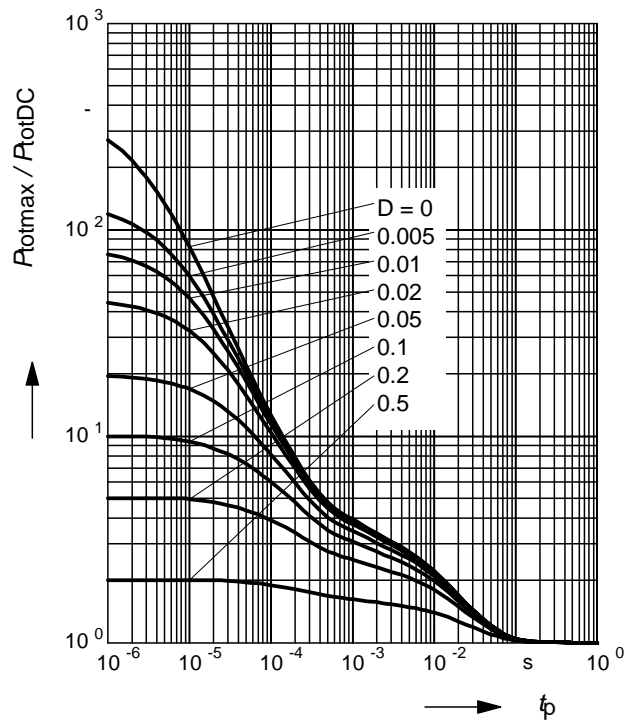

**DC current gain  $h_{FE} = f(I_C)$**

$V_{CE} = 10V$ , normalized

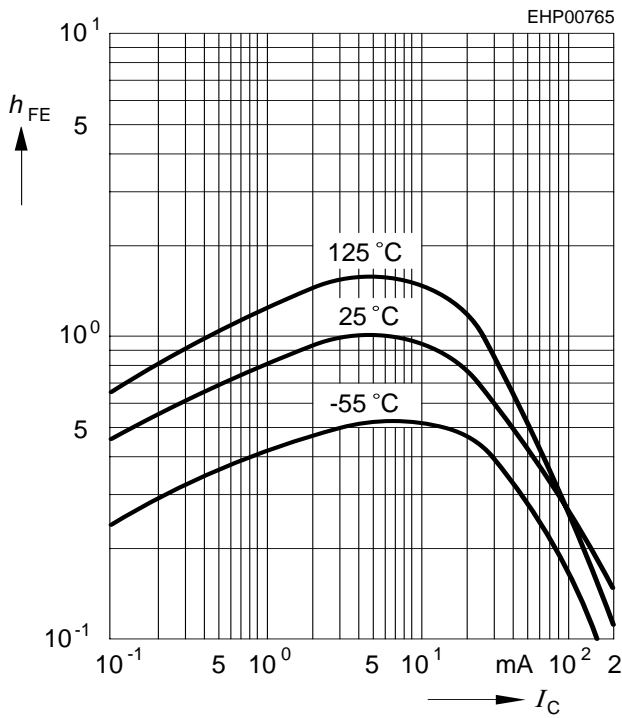

**Saturation voltage  $I_C = f(V_{BEsat}, V_{CEsat})$**

$h_{FE} = 10$

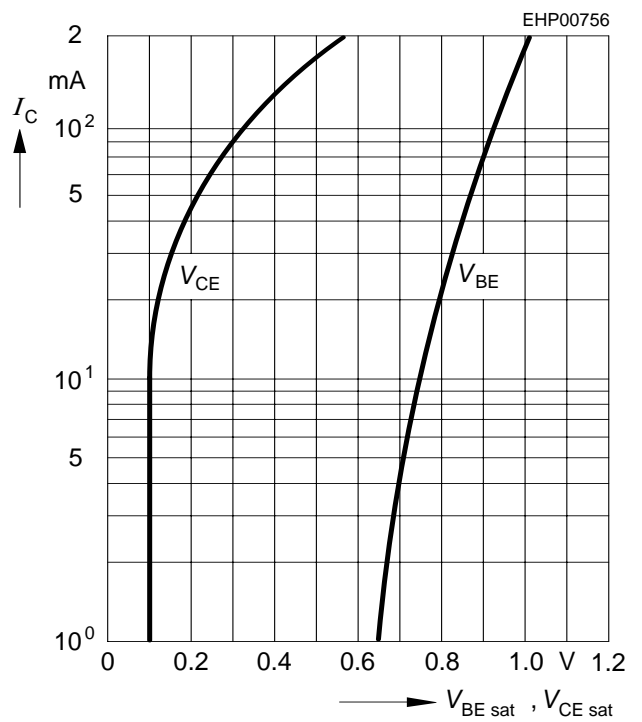

**Short-circuit forward current transfer ratio  $h_{21e} = f(I_C)$**

$V_{CE} = 10V, f = 1MHz$

$V_{CE} = 10V, f = 1MHz$

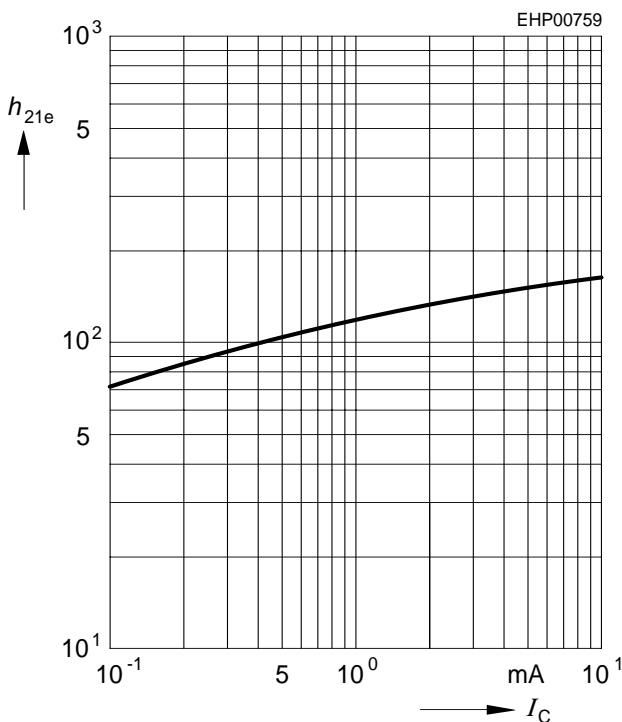

**Open-circuit output admittance  $h_{22e} = f(I_C)$**

$h_{22e} = f(I_C)$

$V_{CE} = 10V, f = 1MHz$

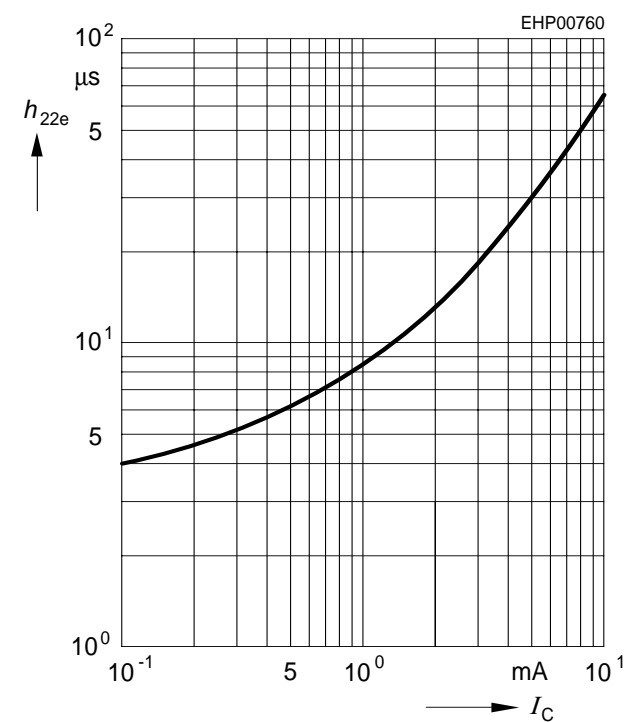

Delay time  $t_d = f(I_C)$

Rise time  $t_r = f(I_C)$

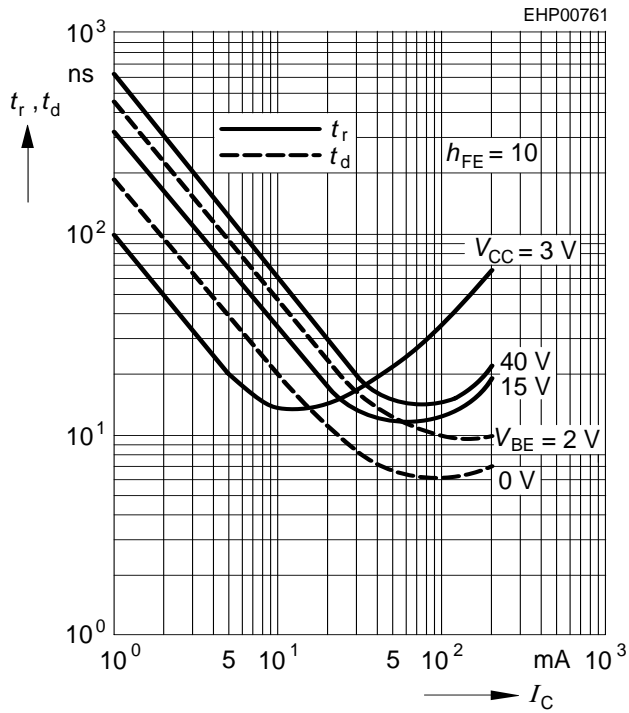

Storage time  $t_{stg} = f(I_C)$

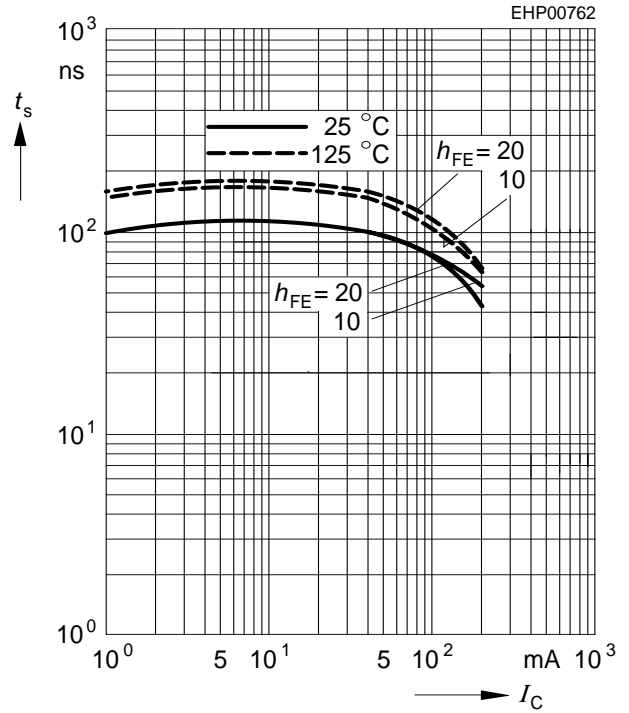

Fall time  $t_f = f(I_C)$

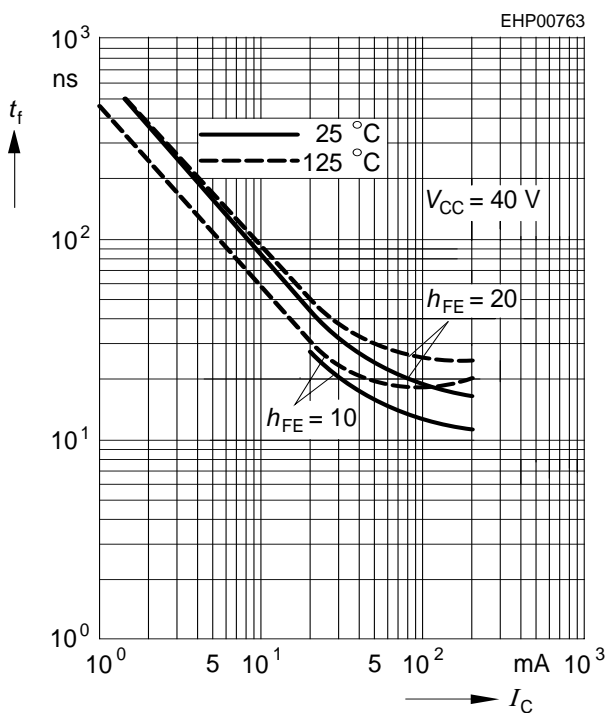

Rise time  $t_r = f(I_C)$

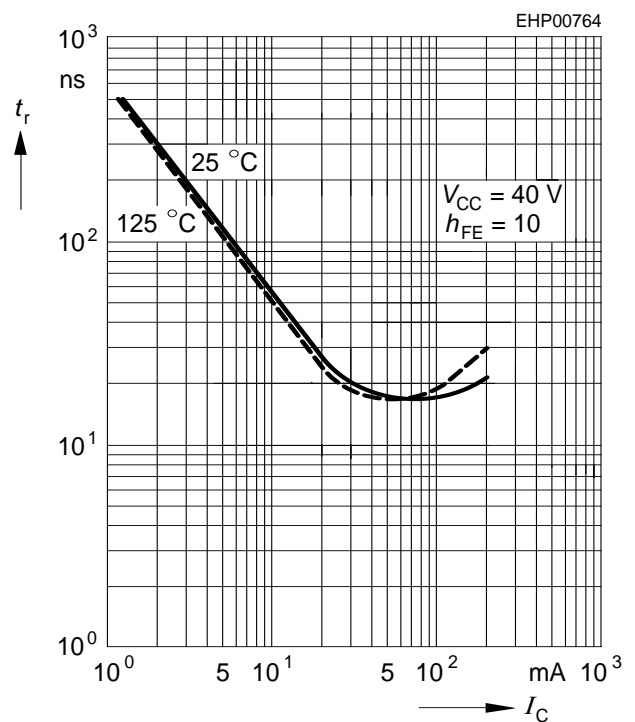

**Input impedance**

$$h_{11e} = f(I_C)$$

$V_{CE} = 10V, f = 1kHz$

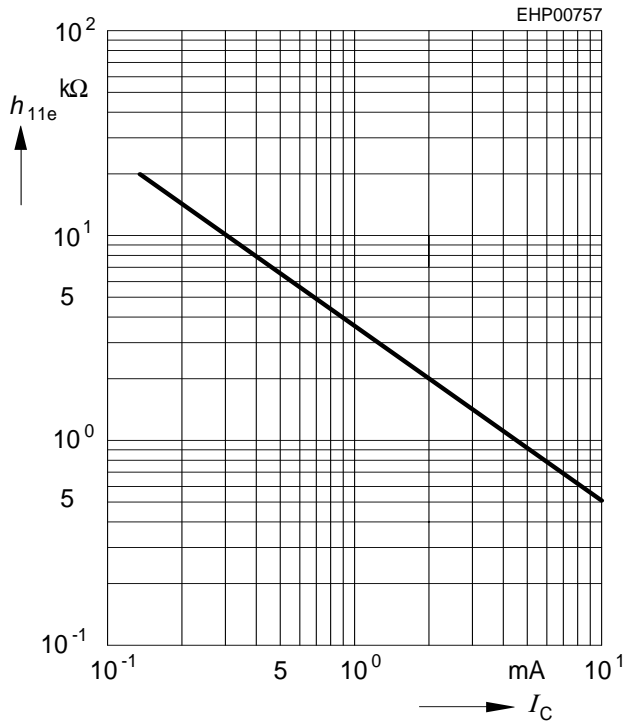

**Open-circuit reverse voltage transfer ratio**

$$h_{12e} = f(I_C)$$

$V_{CE} = 10V, f = 1kHz$

