

# SHINDENGEN

## Schottky Rectifiers (SBD)

Single

# D5S6M

## 60V 5A

### FEATURES

- Tj150
- $P_{RRSM}$  avalanche guaranteed
- Fully Isolated Molding

### APPLICATION

- Switching power supply
- DC/DC converter
- Home Appliances, Office Equipment
- Telecommunication

### OUTLINE DIMENSIONS

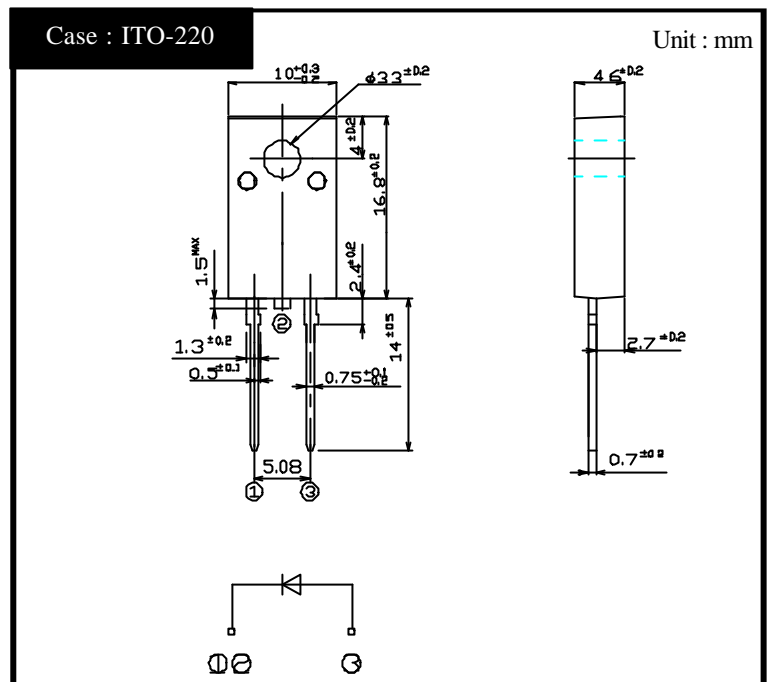

### RATINGS

Absolute Maximum Ratings (If not specified T<sub>c</sub>=25 )

Item	Symbol	Conditions	Ratings	Unit
Storage Temperature	T <sub>stg</sub>		-55 ~ 150	
Operating Junction Temperature	T <sub>j</sub>		150	
Maximum Reverse Voltage	V <sub>RM</sub>		60	V
Repetitive Peak Surge Reverse Voltage	V <sub>RRSM</sub>	Pulse width 0.5ms, duty 1/40	65	V
Average Rectified Forward Current	I <sub>O</sub>	50Hz sine wave, R-load, T <sub>c</sub> =130	5	A
Peak Surge Forward Current	I <sub>FSM</sub>	50Hz sine wave, Non-repetitive 1 cycle peak value, T <sub>j</sub> =125	100	A
Repetitive Peak Surge Reverse Power	P <sub>RRSM</sub>	Pulse width 10 μs, T <sub>j</sub> = 25	330	W
Dielectric Strength	V <sub>dis</sub>	Terminals to case, AC 1 minute	1.5	kV
Mounting Torque	TOR	(Recommended torque 0.3N·m)	0.5	N·m

Electrical Characteristics (If not specified T<sub>c</sub>=25 )

Item	Symbol	Conditions	Ratings	Unit
Forward Voltage	V <sub>F</sub>	I <sub>F</sub> =5A, Pulse measurement	Max.0.58	V
Reverse Current	I <sub>R</sub>	V <sub>R</sub> =V <sub>RM</sub> , Pulse measurement	Max. 4.5	mA
Junction Capacitance	C <sub>j</sub>	f=1MHz, V <sub>R</sub> =10V	Typ.260	pF
Thermal Resistance	j <sub>c</sub>	junction to case	Max.4.5	/W
	c <sub>f</sub>	case to heatsink	Max.1.5	

# D5S6M

# Forward Voltage

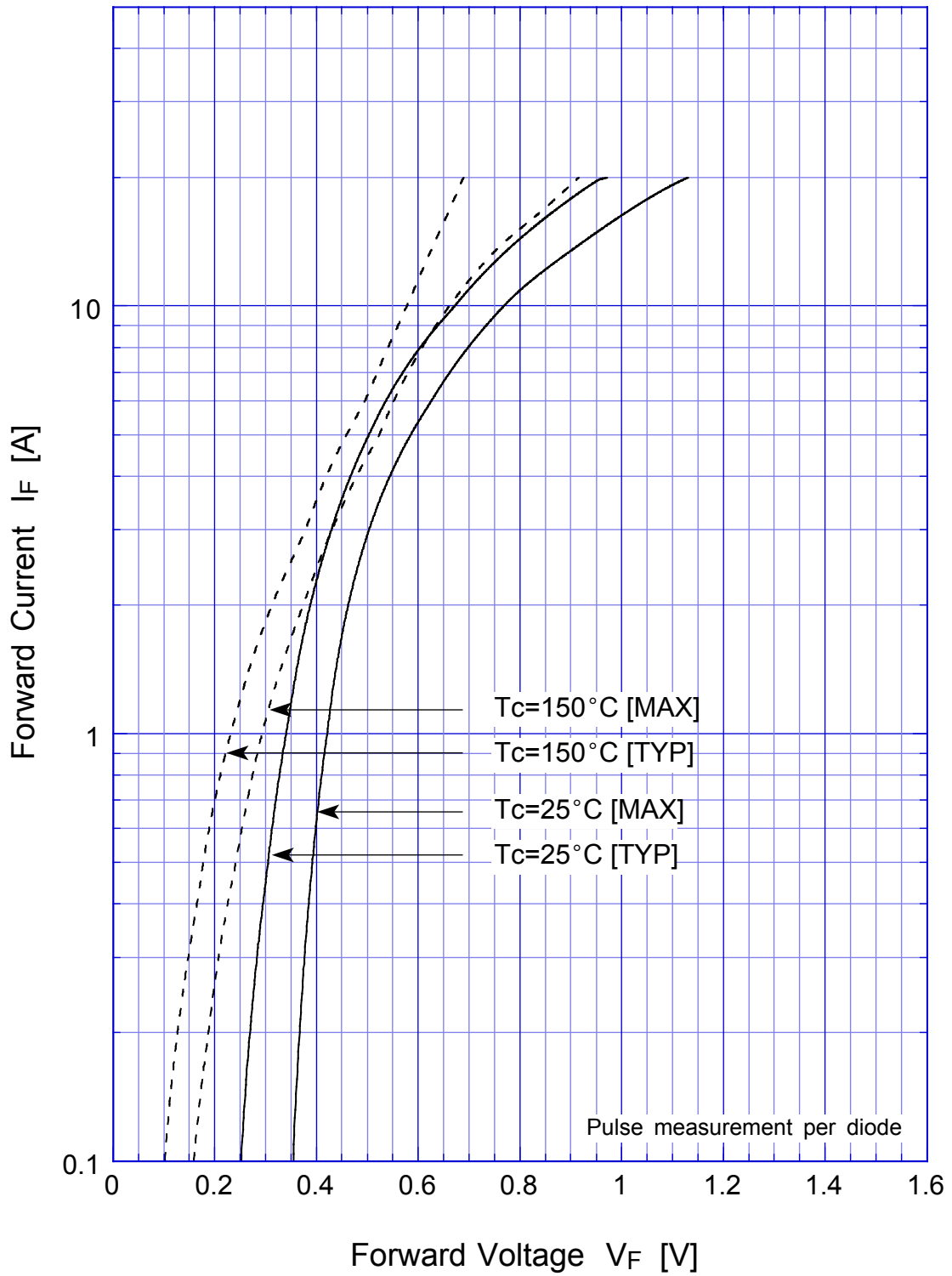

# D5S6M

## Junction Capacitance

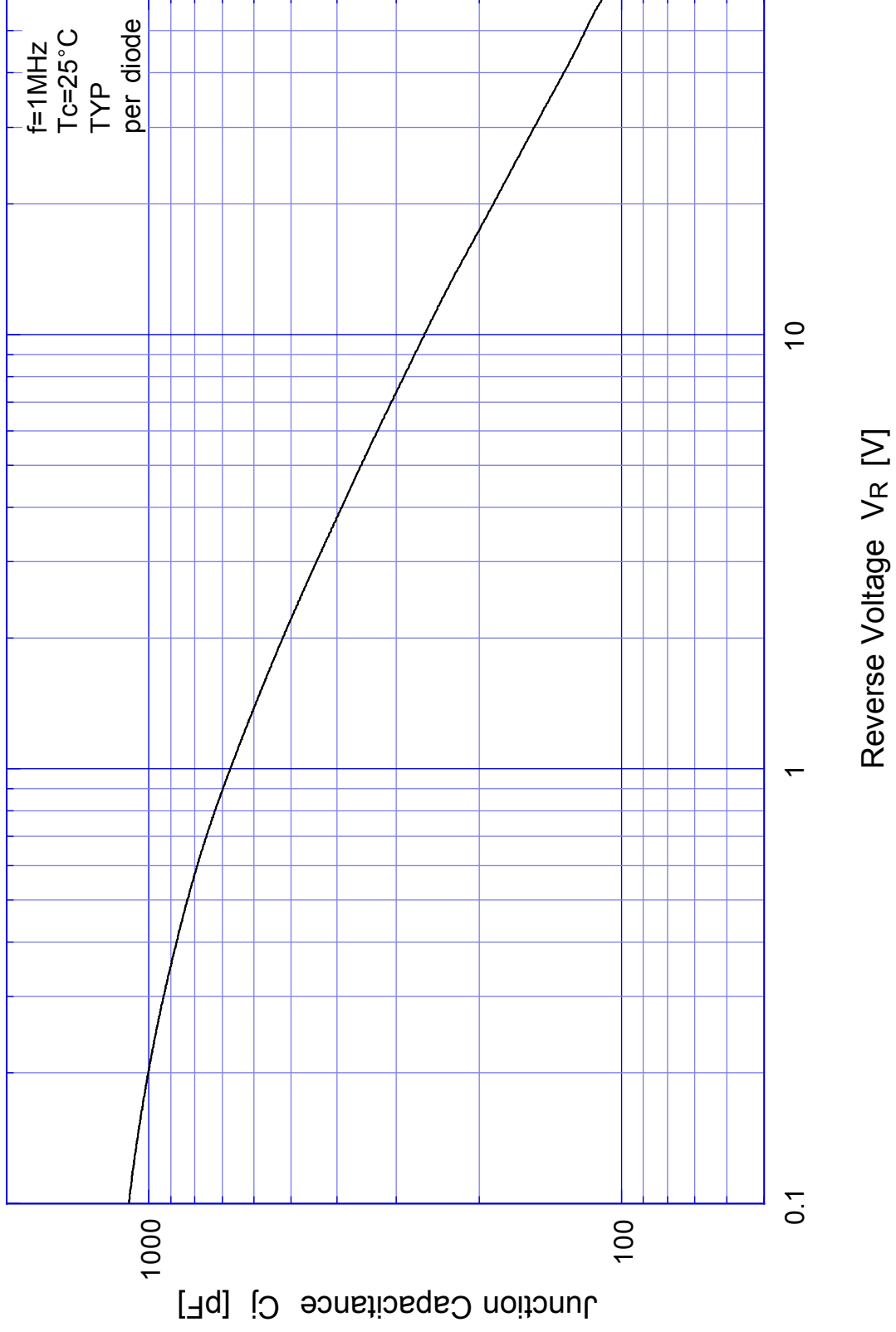

# D5S6M

# Reverse Current

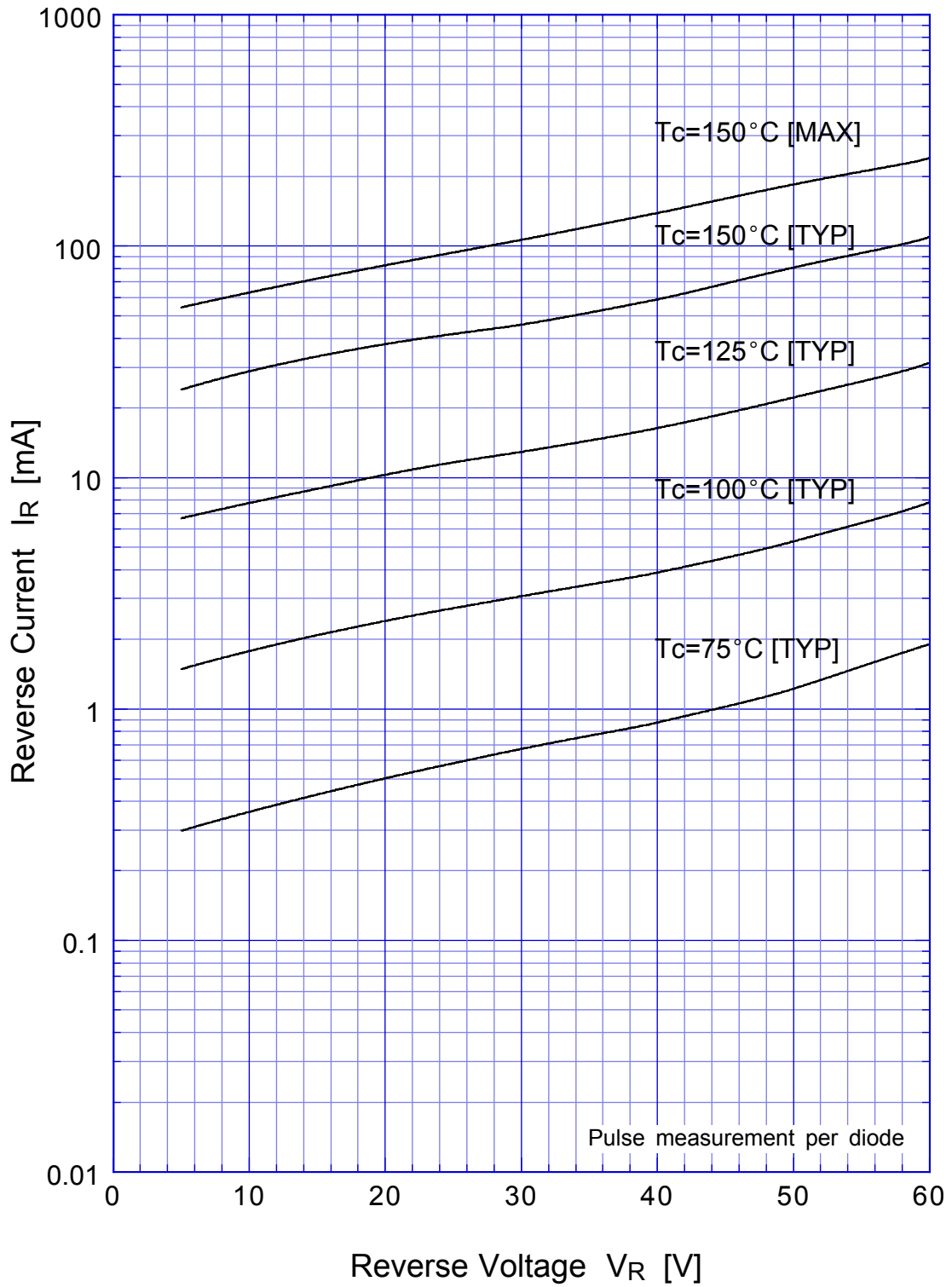

# D5S6M

## Reverse Power Dissipation

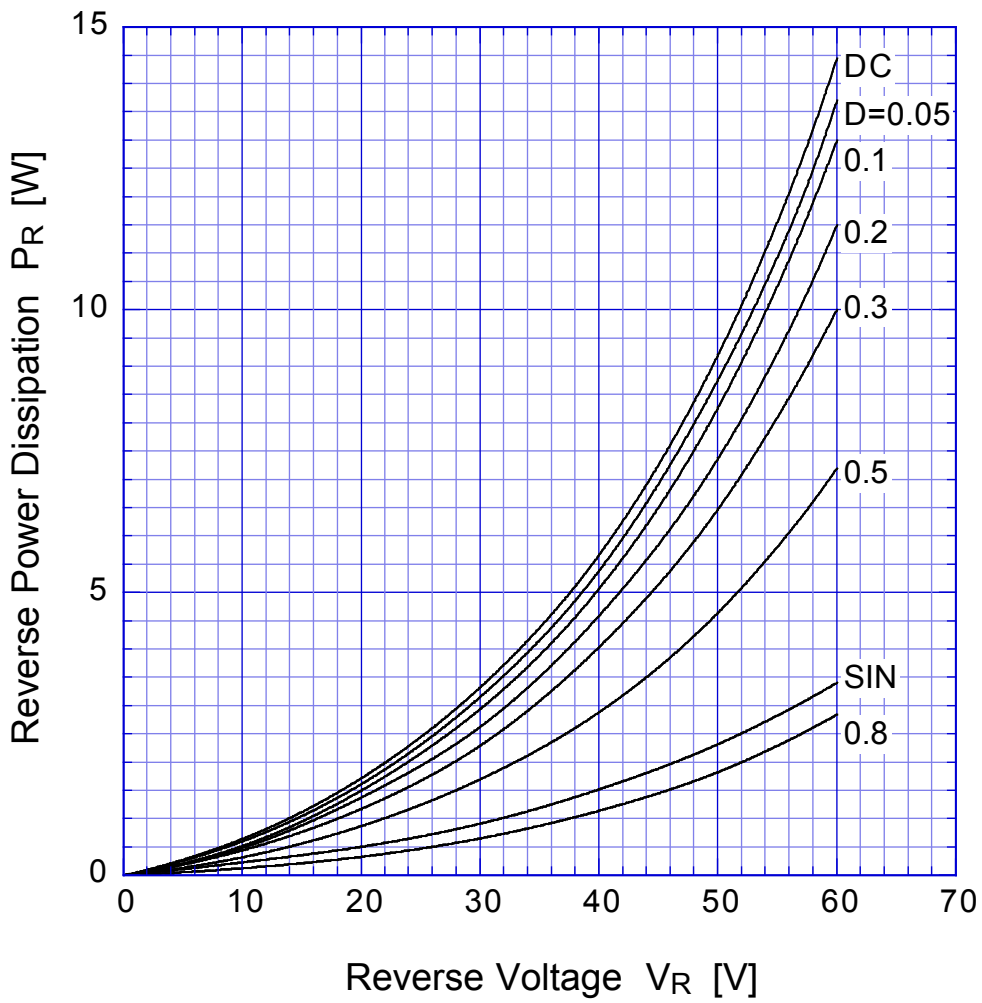

$T_j = 150^\circ\text{C}$

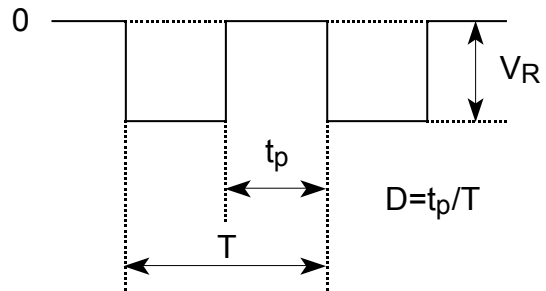

# D5S6M

## Forward Power Dissipation

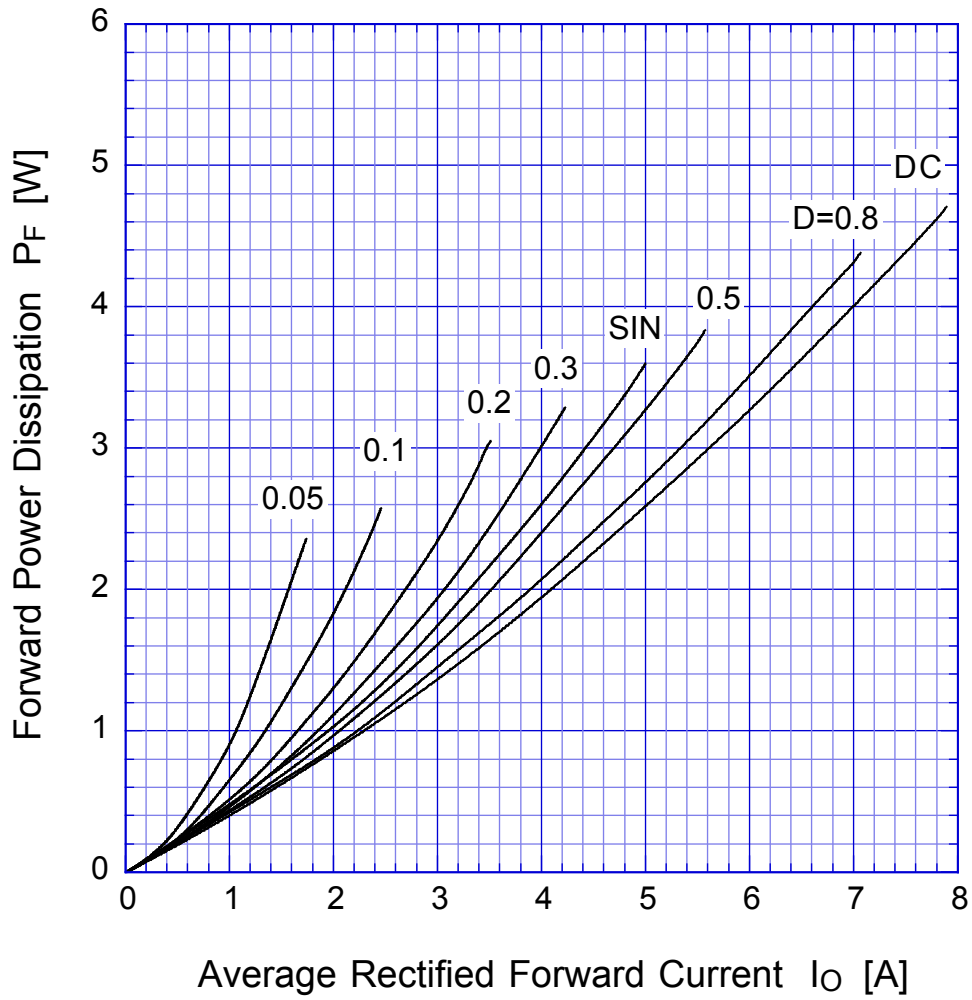

$T_j = 150^\circ\text{C}$

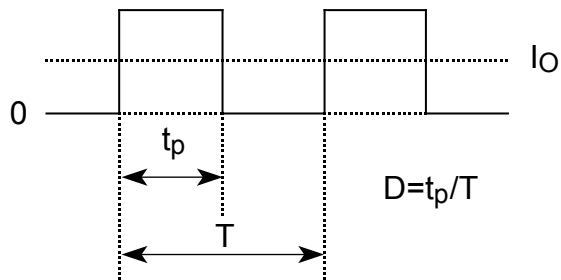

# D5S6M

# Derating Curve

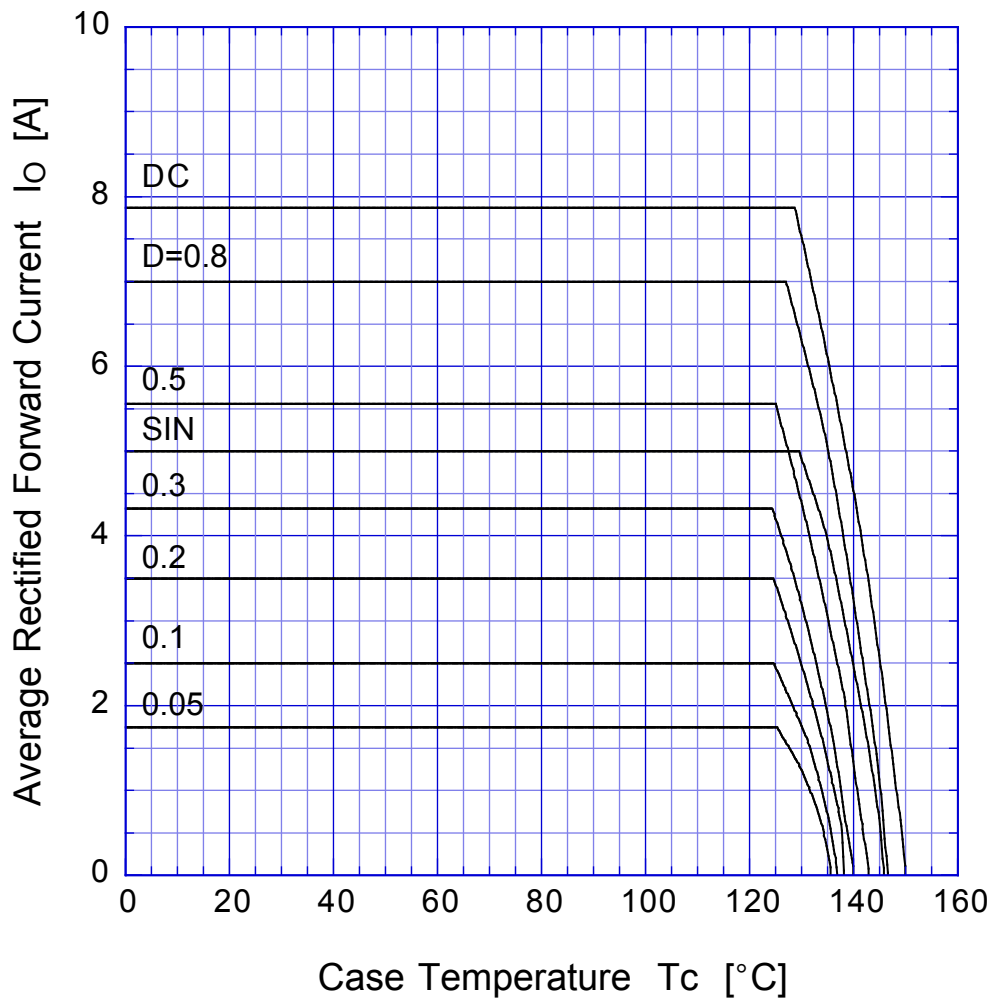

$V_R = 30V$



# D5S6M

# Derating Curve

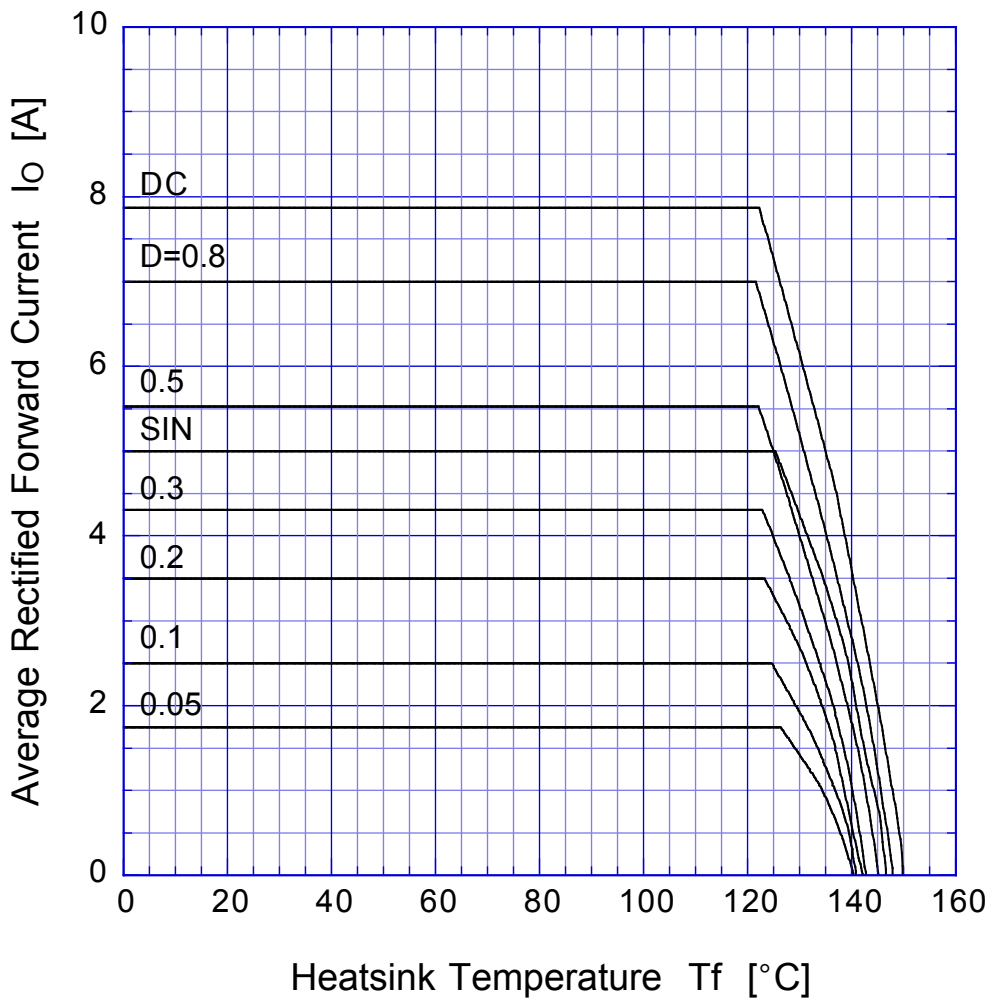

$V_R = 30V$

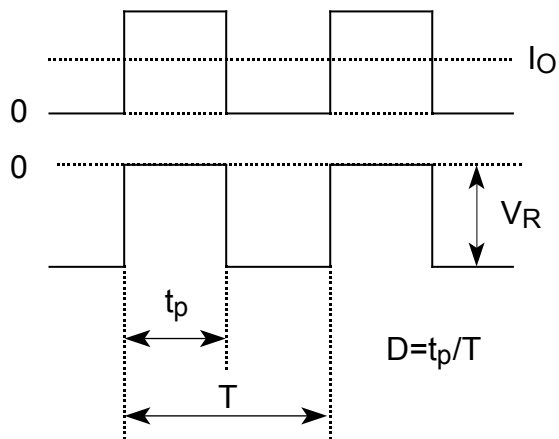



# D5S6M

## Peak Surge Forward Capability

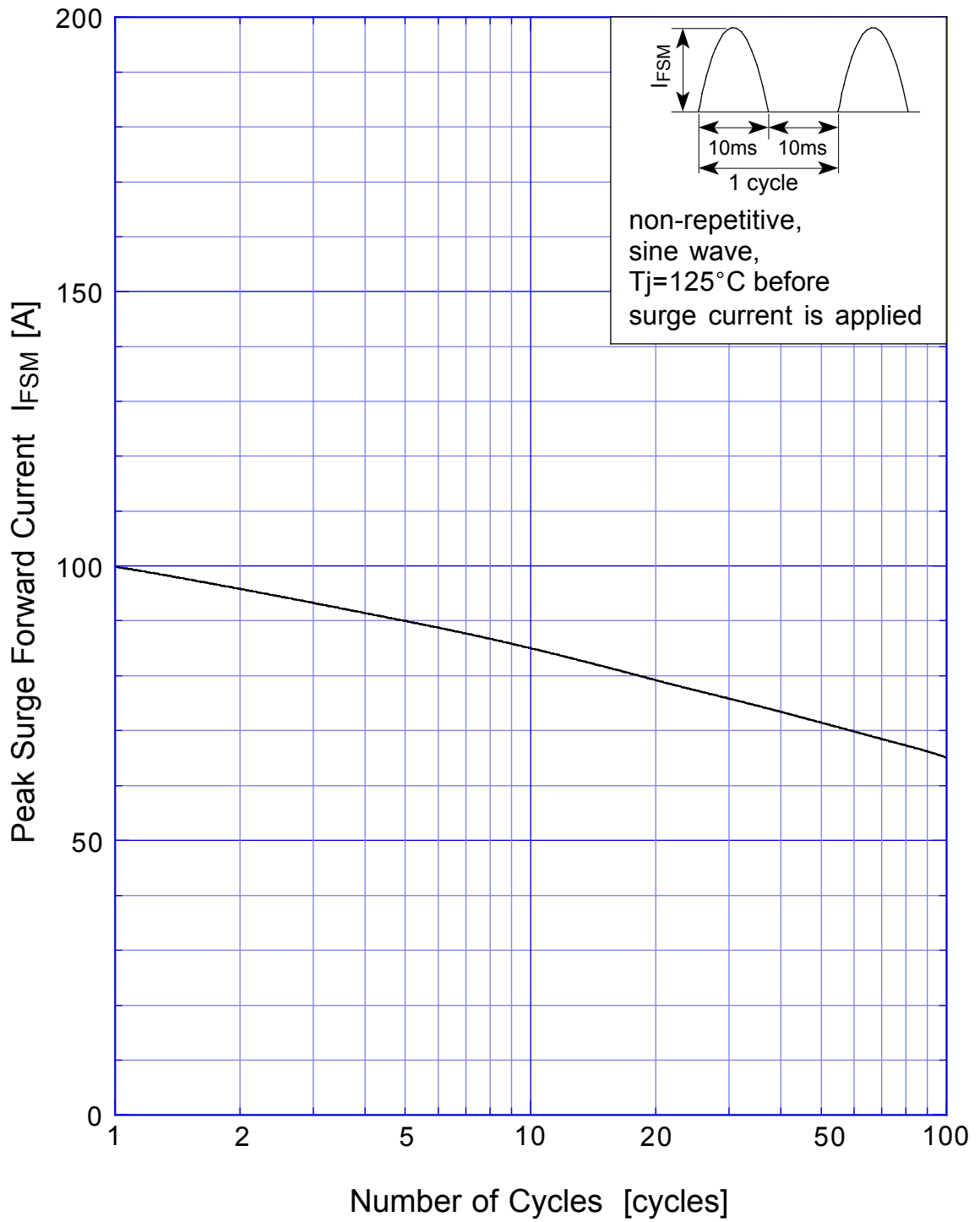

# SBD Repetitive Surge Reverse Power Derating Curve

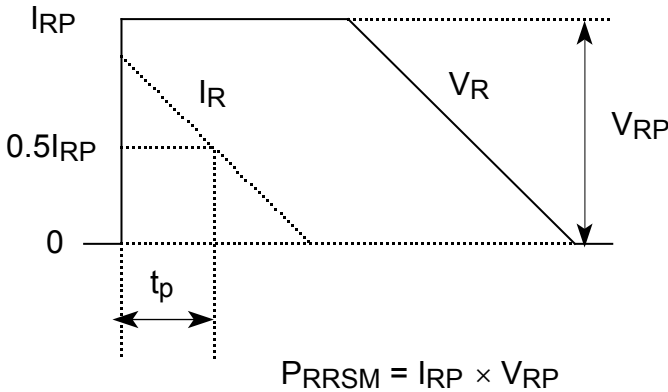
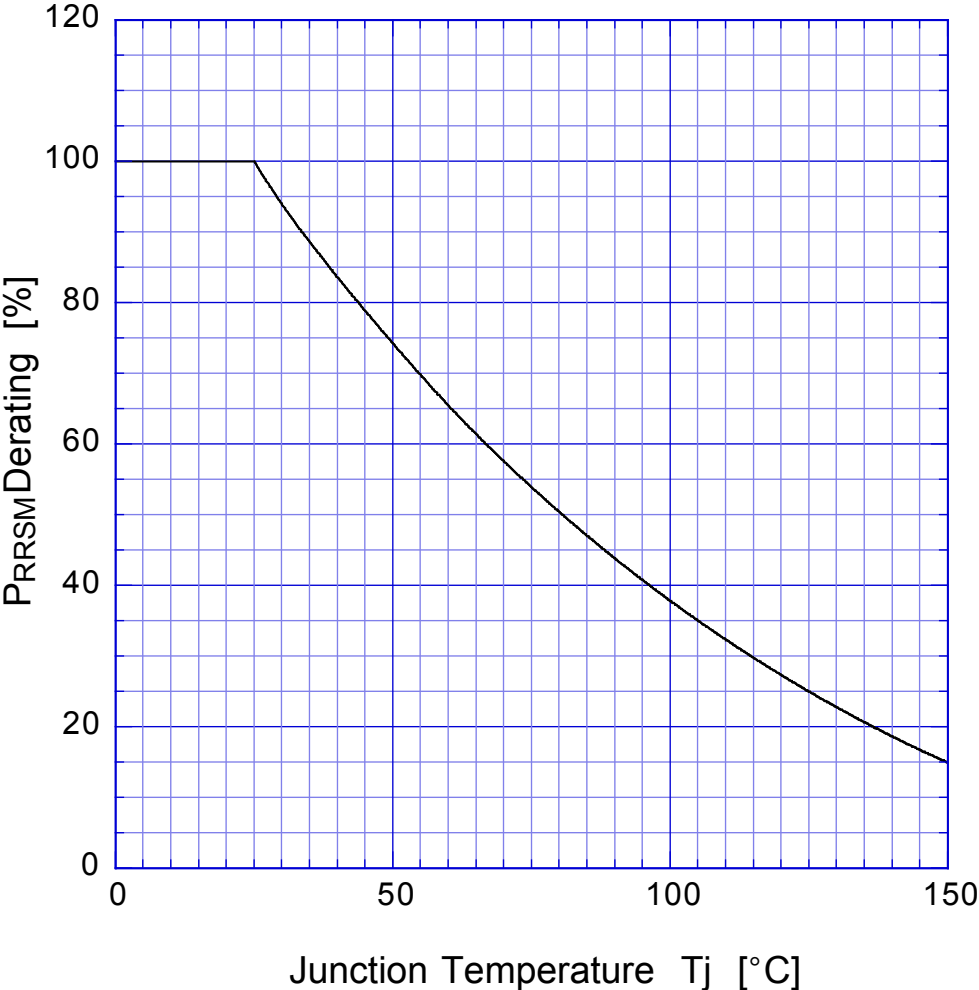

# SBD

## Repetitive Surge Reverse Power Capability

