

## Features

- Low offset voltage—0.5 mV typ., 2 mV max
- Low supply current—13 mA typ., 17 mA max
- Very high Slew Rate—200 V/ $\mu$ s
- Wide gain-bandwidth—150 MHz
- Power bandwidth—6.5 MHz
- Fast settling—70 ns
- Input voltage noise—6 nV/ $\sqrt{\text{Hz}}$
- MIL-STD-883 Rev. C compliant
- Improved replacement for HA5190/5195

## Applications

- Fast, precise D/A converters
- High speed sample-and-hold circuits
- Pulse and video amplifiers
- Wideband amplifiers

## Ordering Information

Part No.	Temp. Range	Package	Outline #
EL2190G	-55°C to +125°C	12-Pin TO-8	MDP0002
EL2190G/883B	55°C to +125°C	12-Pin TO-8	MDP0002
EL2190J	55°C to +125°C	14-Pin CerDIP	MDP0014
EL2190J/883B	55°C to +125°C	14-Pin CerDIP	MDP0014
EL2190L/883B	55°C to +125°C	20-Pad LCC	MDP0007
EL2195CJ	0°C to +75°C	14-Pin CerDIP	MDP0014
EL2195CG	0°C to +75°C	12-Pin TO-8	MDP0002

59628778402 is the SMD version of this device.

## General Description

The EL2190/EL2195 are an improved design over the HA5190/HA5195 monolithic operational amplifiers. The EL2190/EL2195 feature a zener zapped trim design for tighter offset voltage, and a supply current 40% less than the previous generation devices. Employing patented circuit techniques and monolithic Complementary Bipolar construction, these devices are capable of delivering a 200 V/ $\mu$ s slew rate and 70 ns settling times with only 13 mA supply current. These truly differential amplifiers are designed to operate at gains  $\geq 5$  without the need for external compensation. Other outstanding EL2190/EL2195 features are 150 MHz gain-bandwidth product and 6.5 MHz full power bandwidth. In addition to these dynamic characteristics, these amplifiers also have excellent input characteristics such as 2 mV max offset voltage and 6.0 nV/ $\sqrt{\text{Hz}}$  input voltage noise (at 1 kHz).

These devices make ideal output amplifiers for accurate, high speed D/A converters or the main components in high speed sample and hold circuits. 150 MHz gain-bandwidth-product, 6.5 MHz power bandwidth, and 2 mV maximum offset voltage all make the EL2190/EL2195 well suited for a variety of pulse and wideband video amplifier applications.

The EL2190 is specified over the -55°C to +125°C range while the EL2195 is specified from 0°C to +75°C.

Elantec's EL2190/883B complies with MIL-STD-883 Revision C in all aspects, including burn-in at 125°C. Elantec's facilities comply with MIL-I-45208A and other applicable quality specifications. For information on Elantec's military processing, see the Elantec document, QRA-2: *Elantec's Military Processing Monolithic Products*.

## Connection Diagrams

### CerDIP Package

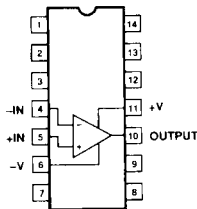

Top View

2190-1

### 20-Lead LCC

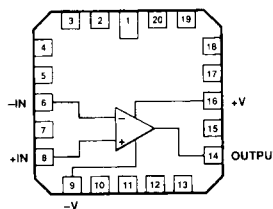

Top View

2190-2

### 12-Lead TO-8

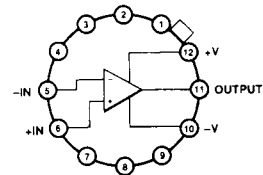

Top View

Note: Case tied to pin 10.

2190-3

Note: Non-designated pins are no connects and are not electrically connected internally.

# EL2190/EL2195

## Wideband, Fast Settling Operational Amplifier

EL2190/EL2195

### Absolute Maximum Ratings ( $T_A = 25^\circ\text{C}$ )

Voltage between V+ and V-	35V	Operating Temperature Range	
Differential Input Voltage	6V	EL2190	-55°C to +125°C
Output Current	50 mA (Peak)	EL2195	0°C to +75°C
	30 mA (Continuous)	Operating Junction Temperature	
Internal Power Dissipation	See Curves	CerDIP, Ceramic LCC, TO-8	175°C
		Lead Temperature	
		(Soldering, 5 seconds)	300°C
		Storage Temperature Range	-65°C to +150°C

#### Important Note:

All parameters having Min/Max specifications are guaranteed. The Test Level column indicates the specific device testing actually performed during production and Quality Inspection. Elantec performs most electrical tests using modern high-speed automatic test equipment, specifically the LTX77 Series system. Unless otherwise noted, all tests are pulsed tests, therefore  $T_J = T_C = T_A$ .

Test Level	Test Procedure
I	100% production tested and QA sample tested per QA test plan QCX0002.
II	100% production tested at $T_A = 25^\circ\text{C}$ and QA sample tested at $T_A = 25^\circ\text{C}$ , $T_{MAX}$ and $T_{MIN}$ per QA test plan QCX0002.
III	QA sample tested per QA test plan QCX0002.
IV	Parameter is guaranteed (but not tested) by Design and Characterization Data.
V	Parameter is typical value at $T_A = 25^\circ\text{C}$ for information purposes only.

### DC Electrical Characteristics $V_S = \pm 15\text{V}$ , $R_L = 200\Omega$ ; unless otherwise specified

Parameter	Description	Temp	EL2190				EL2195				Units
			Min	Typ	Max	Test Level	Min	Typ	Max	Test Level	
V <sub>OS</sub>	Offset Voltage	+25°C		0.5	2	I		0.5	2	I	mV
		Full			6	I			6	III	mV
TCV <sub>OS</sub>	Average Offset Voltage Drift	Full		20		V		20		V	$\mu\text{V}/^\circ\text{C}$
I <sub>B</sub>	Bias Current	+25°C		5	15	I		5	15	I	$\mu\text{A}$
		Full			20	I			20	III	$\mu\text{A}$
I <sub>OS</sub>	Offset Current	+25°C		1	4	I		1	4	I	$\mu\text{A}$
		Full			6	I			6	III	$\mu\text{A}$
R <sub>IN</sub>	Input Resistance	+25°C		10		V		10		V	k $\Omega$
C <sub>IN</sub>	Input Capacitance	+25°C		1		V		1		V	pF
V <sub>CM</sub>	Common Mode Input Range	Full	$\pm 6$	$\pm 10$		I	$\pm 6$	$\pm 10$		II	V
e <sub>IN</sub>	Input Noise Voltage (f = 1 kHz, R <sub>G</sub> = 0 $\Omega$ )	+25°C		6		V		6		V	nV/ $\sqrt{\text{Hz}}$
A <sub>VOL</sub>	Large Signal Voltage Gain (Notes 1, 2)	+25°C	15k	30k		I	10k	30k		I	V/V
		Full	5k			I	5k			III	V/V
CMRR	Common-Mode Rejection Ratio (Note 3)	Full	74	90		I	74	90		II	dB

1

# EL2190/EL2195

## Wideband, Fast Settling Operational Amplifier

### DC Electrical Characteristics $V_S = \pm 15V$ , $R_L = 200\Omega$ ; unless otherwise specified — Contd.

Parameter	Description	Temp	EL2190				EL2195				Units
			Min	Typ	Max	Test Level	Min	Typ	Max	Test Level	
$V_O$	Output Voltage Swing (Notes 1, 11)	Full	$\pm 5$	$\pm 8$		I	$\pm 5$	$\pm 8$		II	V
		Full	$\pm 11$	$\pm 12$		I	$\pm 11$	$\pm 12$		II	V
$I_O$	Output Current	Full	$\pm 25$	$\pm 50$		I	$\pm 25$	$\pm 50$		II	mA
$R_O$	Output Resistance	+25°C		30		V		30		V	$\Omega$
$I_S$	Supply Current	Full		13	17	I		13	17	II	mA
PSRR	Power Supply Rejection Ratio (Note 8)	Full	70	80		I	70	80		II	dB

### AC Electrical Characteristics $V_S = \pm 15V$ , $R_L = 200\Omega$ ; unless otherwise specified

Parameter	Description	Test Conditions	EL2190				EL2195				Units
			Min	Typ	Max	Test Level	Min	Typ	Max	Test Level	
GBW	Gain-Bandwidth Product (Notes 4, 5)	+25°C		150		V		150		V	MHz
FPBW	Full Power Bandwidth (Notes 2, 6)	+25°C	5	6.5		I	5	6.5		I	MHz
$t_r$	Rise Time (Note 7)	+25°C		7	18	IV		7	18	IV	ns
OS	Overshoot (Note 7)	+25°C		25		V		25		V	%
SR	Slew Rate (Note 7)	+25°C	160	200		I	160	200		I	V/ $\mu$ s
$t_s$	Settling Time (Notes 9, 10) 5V Step to 0.1% 5V Step to 0.05%	+25°C		50		V		50		V	ns
		+25°C		70		V		70		V	ns

Note 1:  $R_L = 200\Omega$ ,  $C_L < 10$  pF.

Note 2:  $V_O = \pm 5V$ .

Note 3: Two tests are performed.  $V_{CM} = 0V$  to +5V and  $V_{CM} = 0V$  to -5V.

Note 4:  $V_O = 90$  mV.

Note 5:  $A_V = 10$ .

Note 6: Full Power Bandwidth guaranteed based on slew rate measurement using:  $FPBW = \frac{\text{Slew Rate}}{2\pi V_{\text{peak}}}$ .

Note 7: Refer to Test Circuits section of data sheet.

Note 8: Two tests are performed.  $V^+ = +15V$ , and  $V^-$  is changed from 10V to 20V.  $V^- = -15V$ , and  $V^+$  is changed from +10V to +20V.

Note 9: Settling time measurements are made with techniques in the following reference: "Take The Guesswork Out of Settling-Time Measurements," EDN, September 19, 1985.

Note 10:  $R_L = 1k$ ,  $A_V = -5$ .

Note 11:  $R_L = 1k$ .

# EL2190/EL2195

## Wideband, Fast Settling Operational Amplifier

EL2190/EL2195

### Typical Performance Curves

Input Offset Voltage vs Supply Voltage

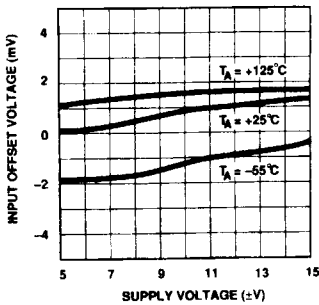

Supply Current vs Supply Voltage

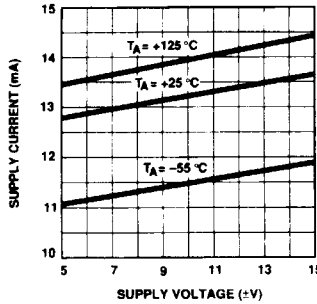

Input Currents vs Temperature

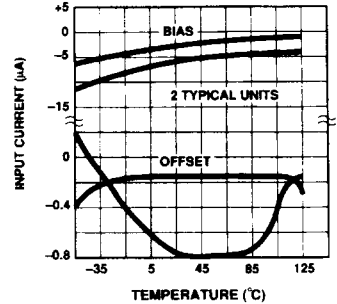

Input Offset Voltage vs Temperature (3 Typical Units)

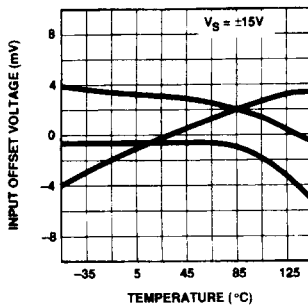

Voltage Gain vs Supply Voltage

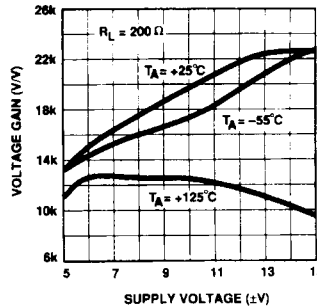

±Slew Rate vs Supply Voltage

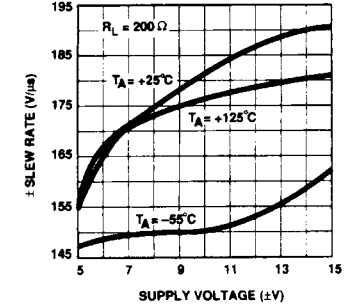

Open Loop Voltage Gain vs Frequency

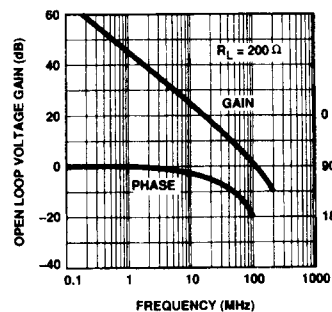

Output Voltage Swing vs Frequency

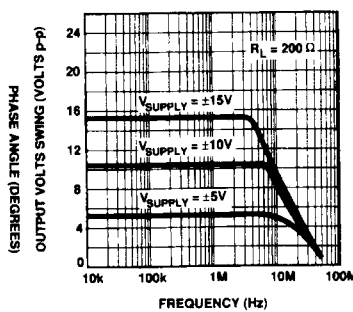

Gain Bandwidth Product at 10 MHz vs Supply Voltage

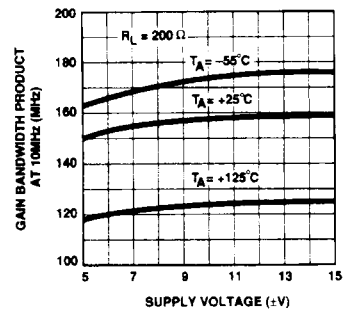

2190-4

1

# EL2190/EL2195

## Wideband, Fast Settling Operational Amplifier

### Typical Performance Curves — Contd.

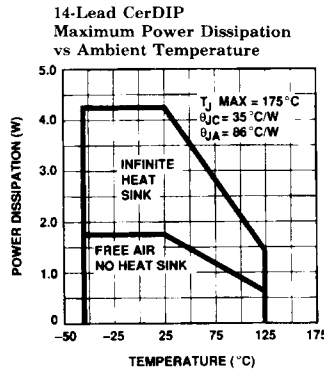
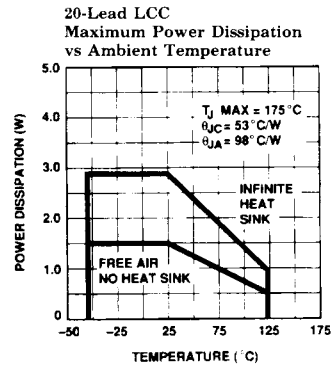
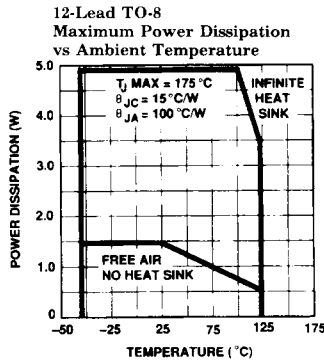
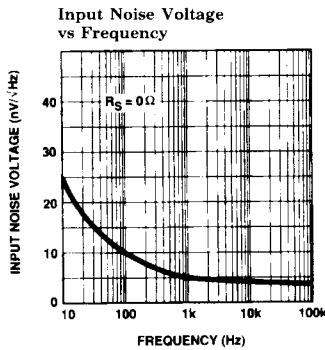
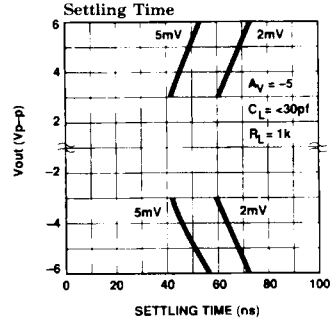
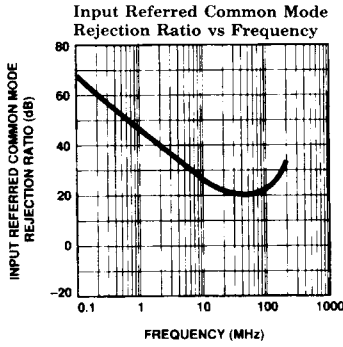
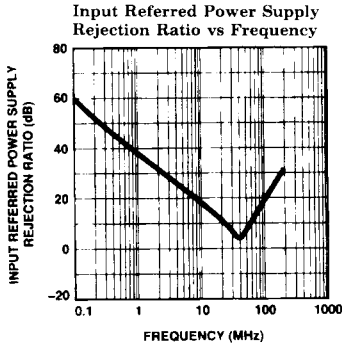

# EL2190/EL2195

## Wideband, Fast Settling Operational Amplifier

EL2190/EL2195

### Typical Performance Curves — Contd.

**Large Signal Response**

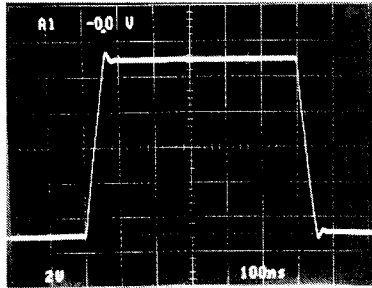

$V_{IN} = \pm 1V$   
 $V_O = \pm 5V$

2190-6

**Small Signal Response**

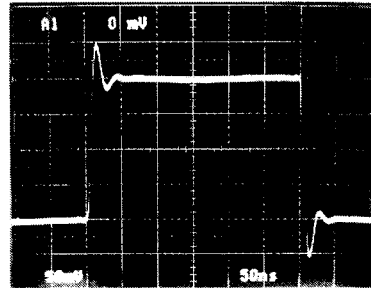

$V_{IN} = \pm 20\text{ mV}$   
 $V_O = \pm 100\text{ mV}$

2190-7

### Burn-In Circuit

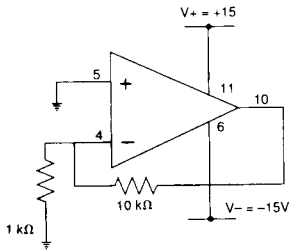

2190-8

Pin numbers are for 14-lead cerDIP. Burn-in circuit is identical for all package types.

### Test Circuit

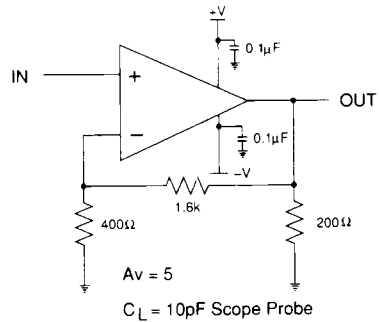

2190-9

1

# EL2190/EL2195

Wideband, Fast Settling Operational Amplifier

## Schematic

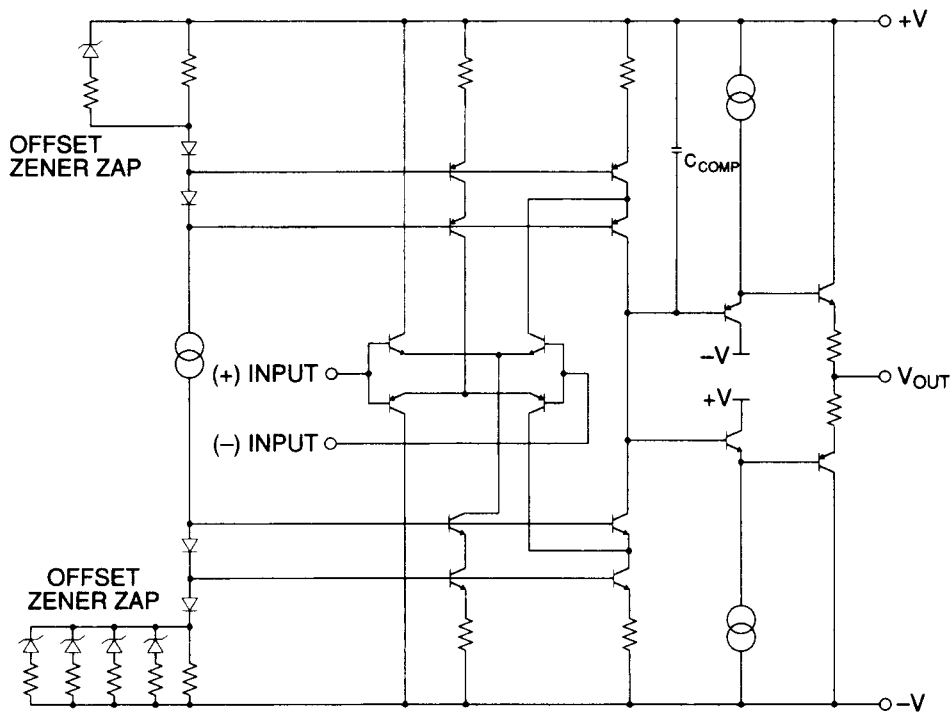

2190-10

# EL2190/EL2195

## Wideband, Fast Settling Operational Amplifier

EL2190/EL2195

### EL2190 Macromodel

```

* Connections:  + input
*               |
*               | -input
*               | |
*               | | + Vsupply
*               | | - Vsupply
*               | |
*               | | output
*               | |

```

```
.subckt M2190 5 4 11 6 10
```

**\* Input Stage**

```

ie 37 6 2mA
r6 36 37 60
r7 38 37 60
rc1 11 30 75
rc2 11 39 75
q1 30 5 36 qn
q2 39 4 38 qna
ediff 33 0 39 30 7.25
rdiff 33 0 1Meg

```

**\* Compensation Section**

```

ga 0 34 33 0 2.6m
rh 34 0 1.5Meg
ch 34 0 3.5pF
rc 34 40 600
cc 40 0 7pF

```

**\* Poles**

```

ep 41 0 40 0 1
rpa 41 42 75
cpa 42 0 5pF
rpb 42 43 50
cpb 43 0 5pF

```

**\* Output Stage**

```

ios1 11 50 1.25mA
ios2 51 6 1.25mA
q3 6 43 50 qp
q4 11 43 51 qn
q5 11 50 52 qn
q6 6 51 53 qp
ros1 52 10 25
ros2 10 53 25

```

**\* Power Supply Current**

```
ips 11 6 8.5mA
```

**\* Models**

```

.model qn npn(is = 800E-18 bf = 200 tf = 0.2nS)
.model qna npn(is = 864E-18 bf = 250 tf = 0.2nS)
.model qp pnp(is = 800E-18 bf = 60 tf = 0.2nS)
.ends

```

1



# EL2190/EL2195

Wideband, Fast Settling Operational Amplifier

## EL2190 Macromodel — Contd.

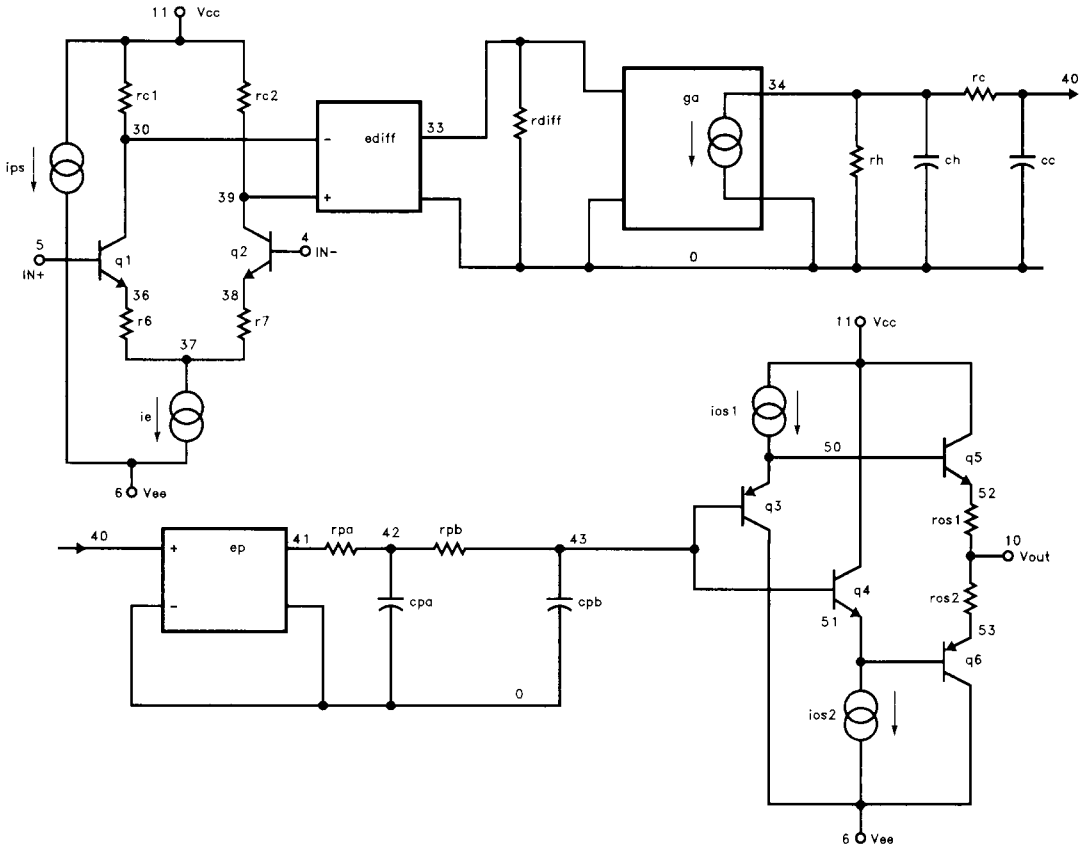

2190-11