

February 2, 1998

TEL:805-498-2111 FAX:805-498-3804 WEB:http://www.semtech.com

DESCRIPTION

The SC1714 is a 3-terminal negative voltage regulator with an output voltage rated at 3.3V below the positive supply voltage. Designed to be an improved plug in replacement for the BA714, it offers a low typical supply current of 12 μ A, a high output current sinking capability of 5mA, and a low negative temperature coefficient. It also features output overload protection. The SC1714 is ideal as a power source for liquid crystal displays.

FEATURES

- Low power supply current.
- Low negative TC.
- High output sinking capability.
- Output overload protection.

APPLICATIONS

- Printing calculators
- Cameras
- Voltage reference for instrumentation

TYPICAL APPLICATION CIRCUIT

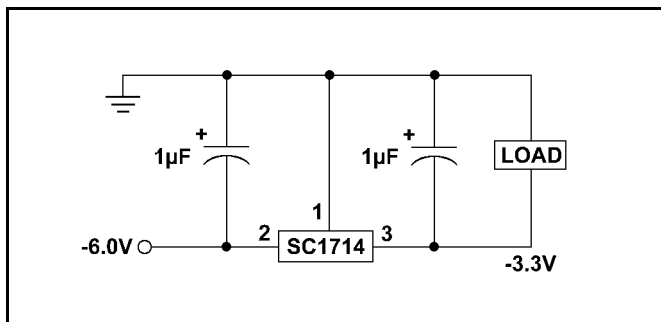

ORDERING INFORMATION

DEVICE ⁽¹⁾	PACKAGE
SC1714ZS5	TO-92

Note:

(1) Add suffix 'TR' for tape and reel.

ABSOLUTE MAXIMUM RATINGS

Parameter	Symbol	Maximum	Units
Supply Voltage	V_{CC}	12.5	V
Power Dissipation	P_D	300	mW
Operating Temperature Range	T_A	-25 to 75	$^{\circ}$ C
Storage Temperature Range	T_{STG}	-55 to 125	$^{\circ}$ C
Output Current	I_{OUT}	50	mA

PIN CONFIGURATION

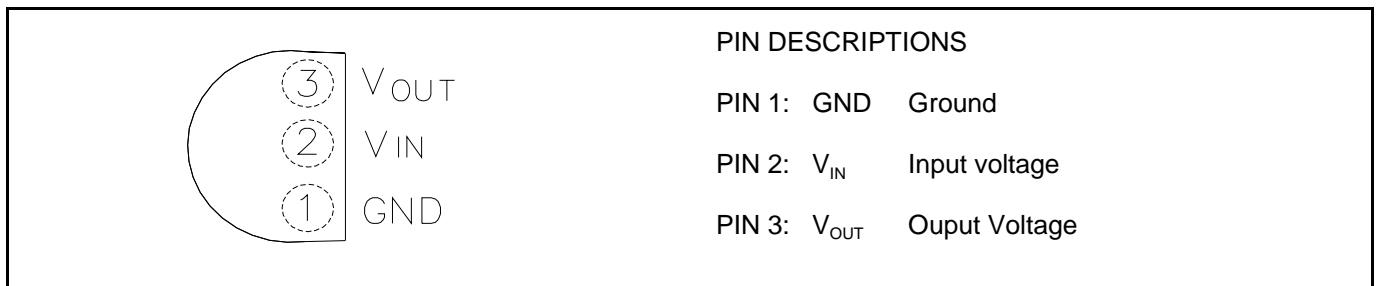

February 2, 1998

ELECTRICAL CHARACTERISTICS

 Unless otherwise specified, $T_A = 25^\circ\text{C}$, $V_{CC} = 6.0\text{V}$

Parameter	Symbol	Conditions	Min	Typ	Max	Units
Output Voltage	V_{OUT}	$V_{CC} = 4-12\text{V}$, $I_{OUT} = 50-300\mu\text{A}$ $T_A = 0^\circ\text{C}-40^\circ\text{C}$	3.2		3.4	V
Supply Current	I_{CC}	$R_L = \infty$		12	17	μA
Output Voltage to Supply Voltage Ratio	V_{OUT}/V_{CC}	$R_L = \infty$		1		mV/V
Output Short Circuit Current	I_{OS}			5	10	mA

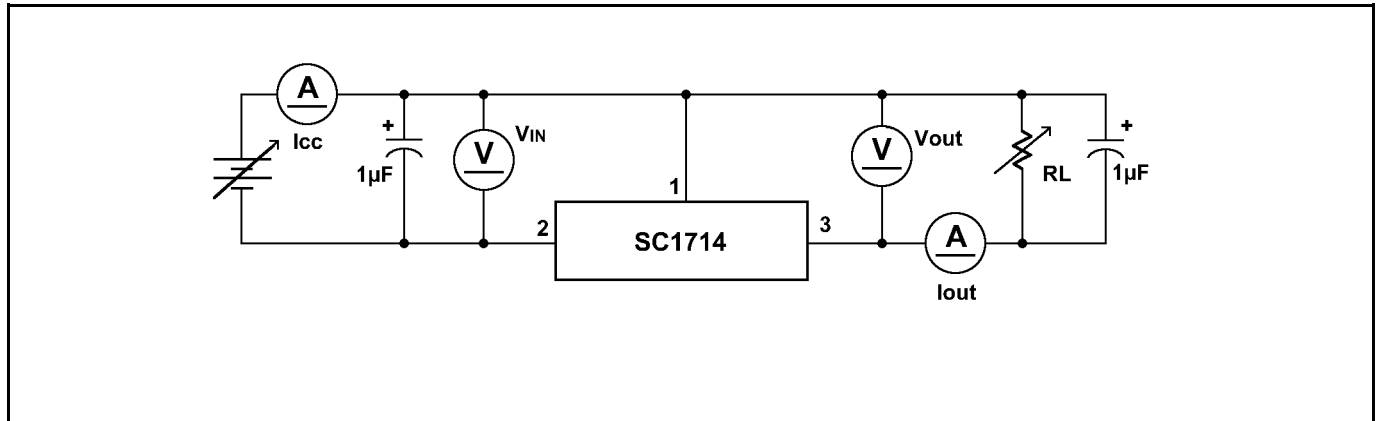
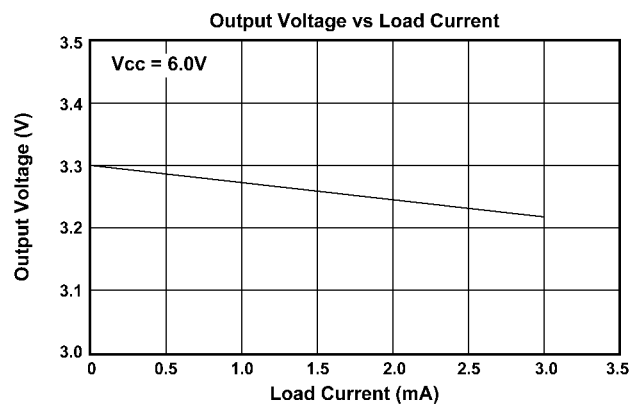
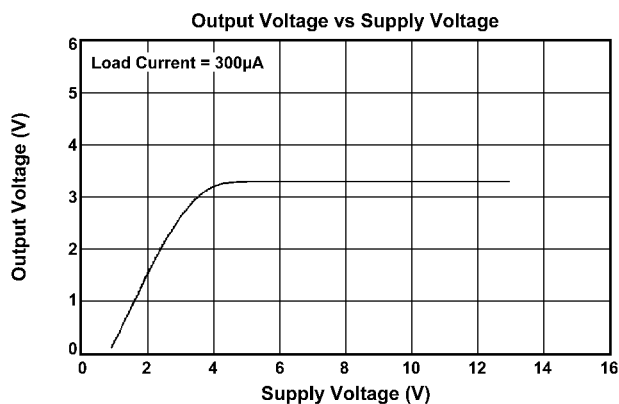
TEST CIRCUIT

TYPICAL PERFORMANCE CHARACTERISTICS

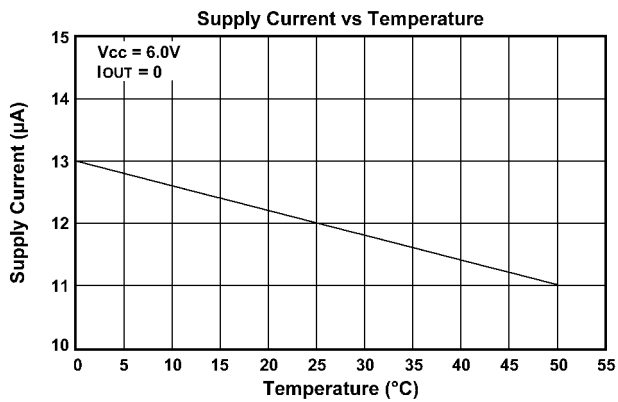
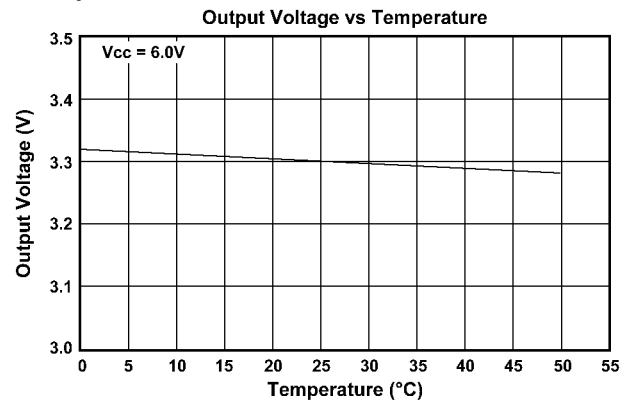
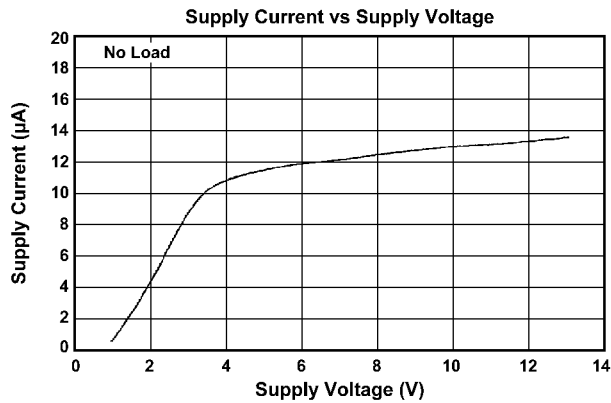
February 2, 1998

TYPICAL PERFORMANCE CHARACTERISTICS (cont.)

DEVICE OUTLINE - TO-92
