

27- 32 GHz 0.7 Watt Power Amplifier

TGA1073B-SCC

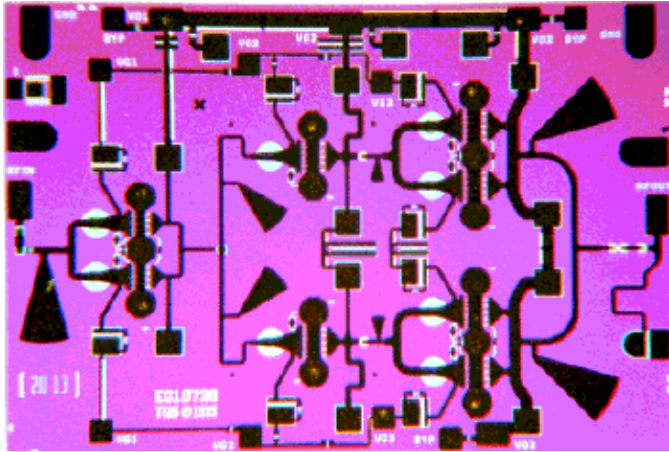

Key Features and Performance

- 0.25 um pHEMT Technology
- 25 dB Nominal Gain @ 28 GHz
- 28.5 dBm Nominal Pout @ P1dB (7V)
- -38 dBc IMR3 @ 18 dBm SCL
- Bias 6 - 8 V @ 420 mA
- Chip Dimensions 3.12mm x 2.15mm

Primary Applications

- Point-to-Point Radio
- Point-to-Multipoint Communications

The TriQuint TGA1073B-SCC is a three stage HPA MMIC design using TriQuint’s proven 0.25 um Power pHEMT process. The TGA1073B is designed to support a variety of millimeter wave applications including point-to-point digital radio and LMDS/LMCS and Ka band satellite ground terminals.

The three stage design consists of a 2 x 300um input stage driving a 2 x 600um interstage followed by a 4 x 600um output stage.

The TGA1073B provides 28.5 dBm nominal output power at 1dB compression across 27-32GHz. Typical small signal gain is 25 dB at 28GHz and 18dB at 32GHz.

The TGA1073B requires minimum off-chip components. Each device is 100% DC and RF tested on-wafer to ensure performance compliance. The device is available in chip form.

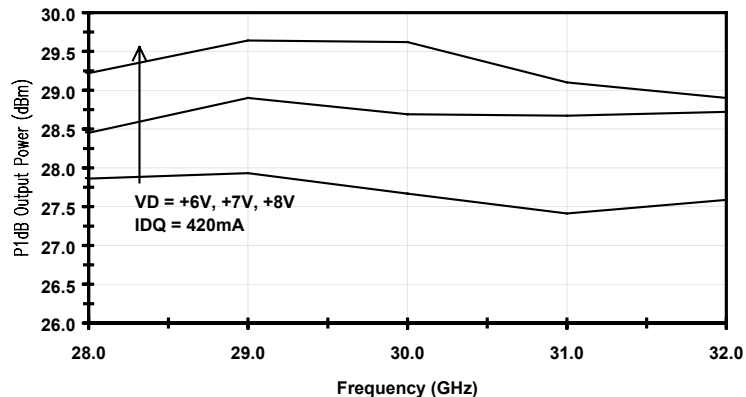
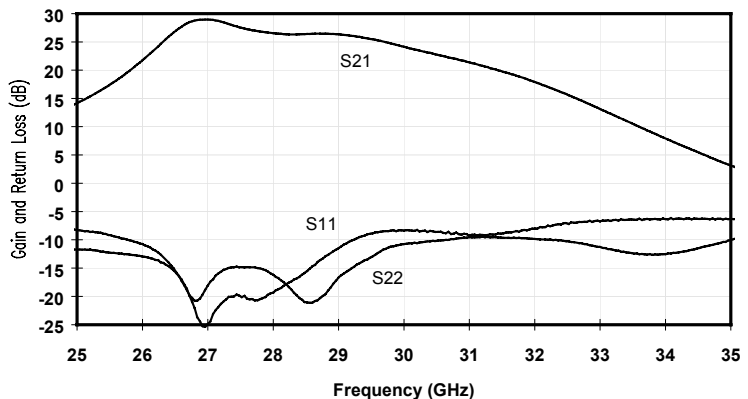

MAXIMUM RATINGS

SYMBOL	PARAMETER ^{4/}	VALUE	NOTES
V ⁺	POSITIVE SUPPLY VOLTAGE	11V	
I ⁺	POSITIVE SUPPLY CURRENT	630 mA	<u>1/</u>
I ⁻	NEGATIVE GATE CURRENT	35.2 mA	
P _{IN}	INPUT CONTINUOUS WAVE POWER	23 dBm	
P _D	POWER DISSIPATION	6.93 W	
T _{CH}	OPERATING CHANNEL TEMPERATURE	150 °C	<u>2/</u> <u>3/</u>
T _M	MOUNTING TEMPERATURE (30 SECONDS)	320 °C	
T _{STG}	STORAGE TEMPERATURE	-65 to 150 °C	

- 1/ Total current for all stages.
- 2/ These ratings apply to each individual FET.
- 3/ Junction operating temperature will directly affect the device median time to failure (T_M). For maximum life, it is recommended that junction temperatures be maintained at the lowest possible levels.
- 4/ These ratings represent the maximum operable values for the device.

DC SPECIFICATIONS (100%)
(T_A = 25 °C ± 5 °C)

NOTES	SYMBOL	TEST CONDITIONS ^{2/}	LIMITS		UNITS
			MIN	MAX	
	I _{DSS1,2}	STD	60	282	mA
	G _{M1,2}	STD	132	318	mS
<u>1/</u>	V _{P1,2}	STD	0.5	1.5	V
<u>1/</u>	V _{P3}	STD	0.5	1.5	V
<u>1/</u>	V _{P4}	STD	0.5	1.5	V
<u>1/</u>	V _{P5,6}	STD	0.5	1.5	V
<u>1/</u>	V _{P7,8}	STD	0.5	1.5	V
<u>1/</u>	V _{BVGD1-8}	STD	11	30	V
<u>1/</u>	V _{BVGS1,2}	STD	11	30	V

- 1/ V_P, V_{BVGD}, and V_{BVGS} are negative.
- 2/ The measurement conditions are subject to change at the manufacture's discretion (with appropriate notification to the buyer).

RF SPECIFICATIONS

(T_A = 25°C ± 5°C)

NOTE	TEST	MEASUREMENT CONDITIONS 6V @ 420mA	VALUE			UNITS
			MIN	TYP	MAX	
<u>1/</u>	SMALL-SIGNAL GAIN MAGNITUDE	27 – 30 GHz	20	25		dB
		31 – 32 GHz	16	20		dB
	POWER OUTPUT AT 1 dB GAIN COMPRESSION	27 – 32 GHz	26.5	28.5		dBm
<u>1/</u>	INPUT RETURN LOSS MAGNITUDE	27 – 32 GHz		-10		dB
<u>1/</u>	OUTPUT RETURN LOSS MAGNITUDE	27 – 32 GHz		-10		dB
<u>2/</u>	OUTPUT THIRD ORDER INTERCEPT			37		dBm

1/ RF probe data is taken at 1 GHz steps.

2/ Minimum output third-order-intercept (OTOI) is generally 6dB minimum above the 1dB compression point (P1dB). Calculations are based on standard two-tone testing with each tone approximately 10dB below the nominal P1dB. Factors that may affect OTOI performance include device bias, measurement frequency, operating temperature, output interface and output power level for each tone.

RELIABILITY DATA

PARAMETER	BIAS CONDITIONS		P _{DISS} (W)	R _{θJC} (C/W)	T _{CH} (°C)	T _M (HRS)
	V _D (V)	I _D (mA)				
R _{θJC} Thermal resistance (channel to backside of c/p)	6	420	2.52	22.58	126.9	8.0 E6

Note: Assumes eutectic attach using 1.5 mil thick 80/20 AuSn mounted to a 20mil CuMo Carrier at 70°C baseplate temperature. Worst case condition with no RF applied, 100% of DC power is dissipated.

TGA1073B Average Performance

Sample Size = 11499 devices

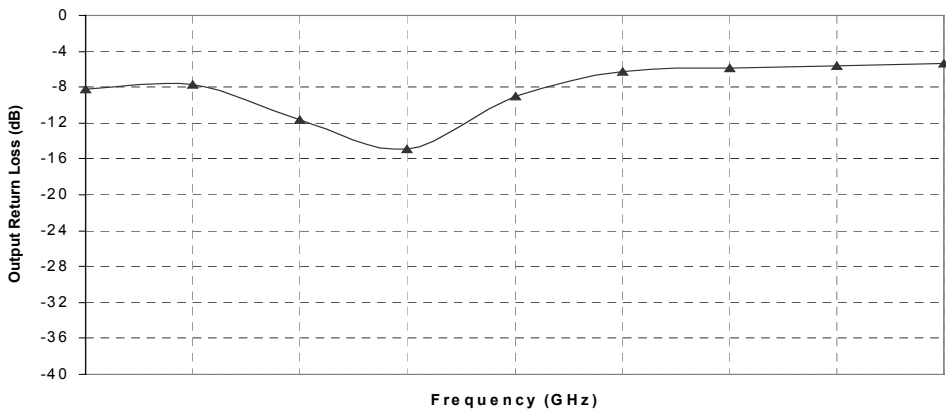
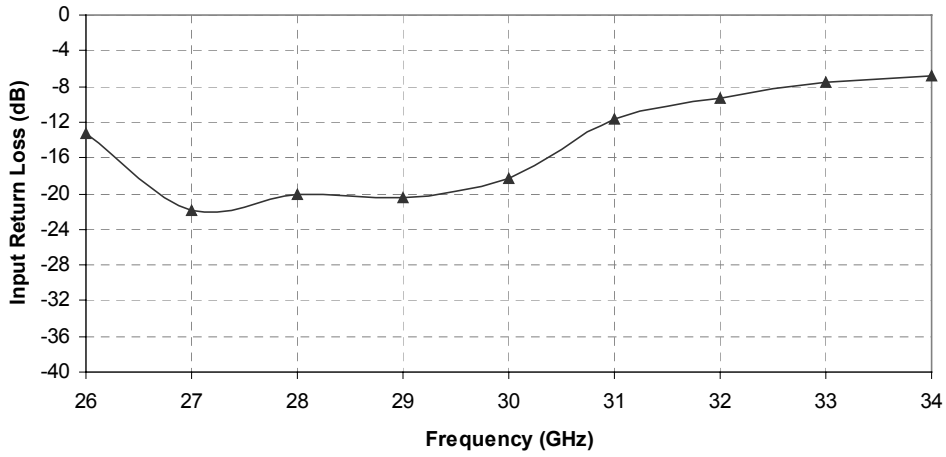
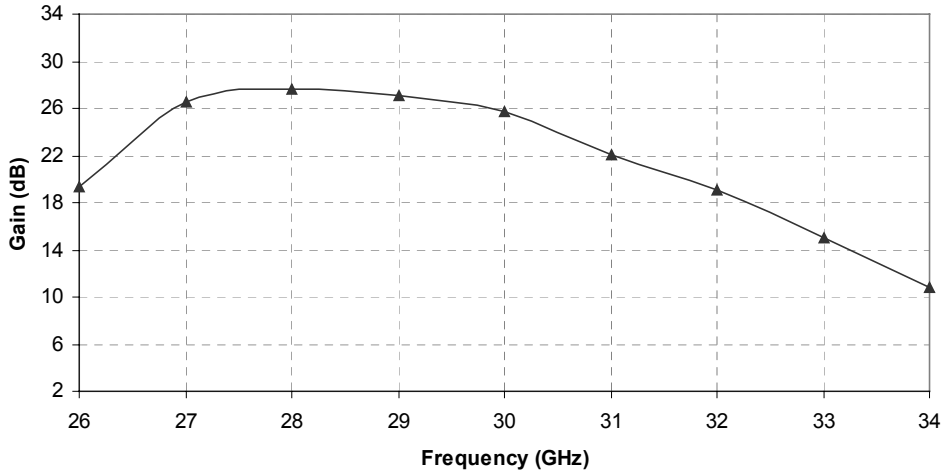

Mechanical Characteristics

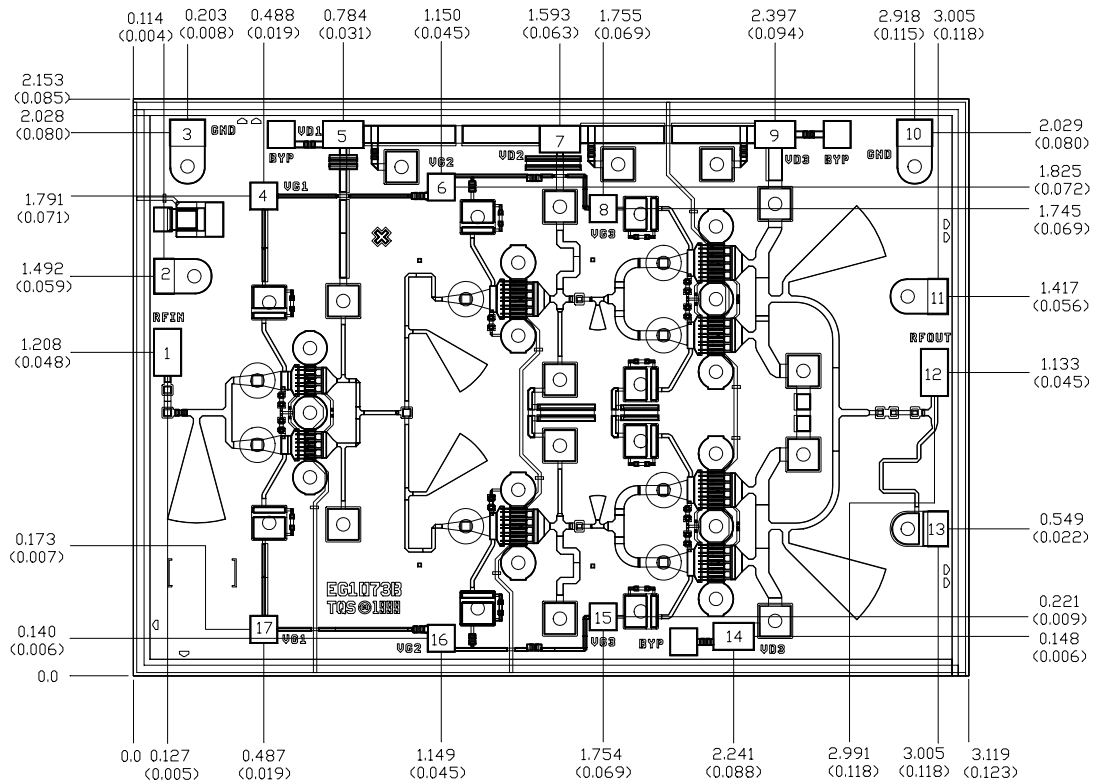

Units: millimeters (inches)
 Thickness: 0.1016 (0.004)
 Chip edge to bond pad dimensions are shown to center of bond pad
 Chip size tolerance: +/- 0.051 (0.002)

Bond Pad #1 (RF Input)	0.105 x 0.180 (0.004 x 0.007)
Bond Pad #2 (GND)	0.078 x 0.136 (0.003 x 0.005)
Bond Pad #3 (GND)	0.103 x 0.136 (0.004 x 0.005)
Bond Pad #4 (VG1)	0.105 x 0.105 (0.004 x 0.004)
Bond Pad #5 (VD1)	0.105 x 0.155 (0.004 x 0.006)
Bond Pad #6 (VG2)	0.105 x 0.105 (0.004 x 0.004)
Bond Pad #7 (VD2)	0.105 x 0.155 (0.004 x 0.006)
Bond Pad #8 (VG3)	0.105 x 0.105 (0.004 x 0.004)
Bond Pad #9 (VD3)	0.105 x 0.155 (0.004 x 0.006)
Bond Pad #10 (GND)	0.103 x 0.136 (0.004 x 0.005)
Bond Pad #11 (GND)	0.078 x 0.136 (0.003 x 0.005)
Bond Pad #12 (RF Output)	0.105 x 0.180 (0.004 x 0.007)
Bond Pad #13 (GND)	0.078 x 0.136 (0.003 x 0.005)
Bond Pad #14 (VD3)	0.105 x 0.155 (0.004 x 0.006)
Bond Pad #15 (VG3)	0.105 x 0.105 (0.004 x 0.004)
Bond Pad #16 (VG2)	0.105 x 0.105 (0.004 x 0.004)
Bond Pad #17 (VG1)	0.105 x 0.105 (0.004 x 0.004)

Chip Assembly and Bonding Diagram

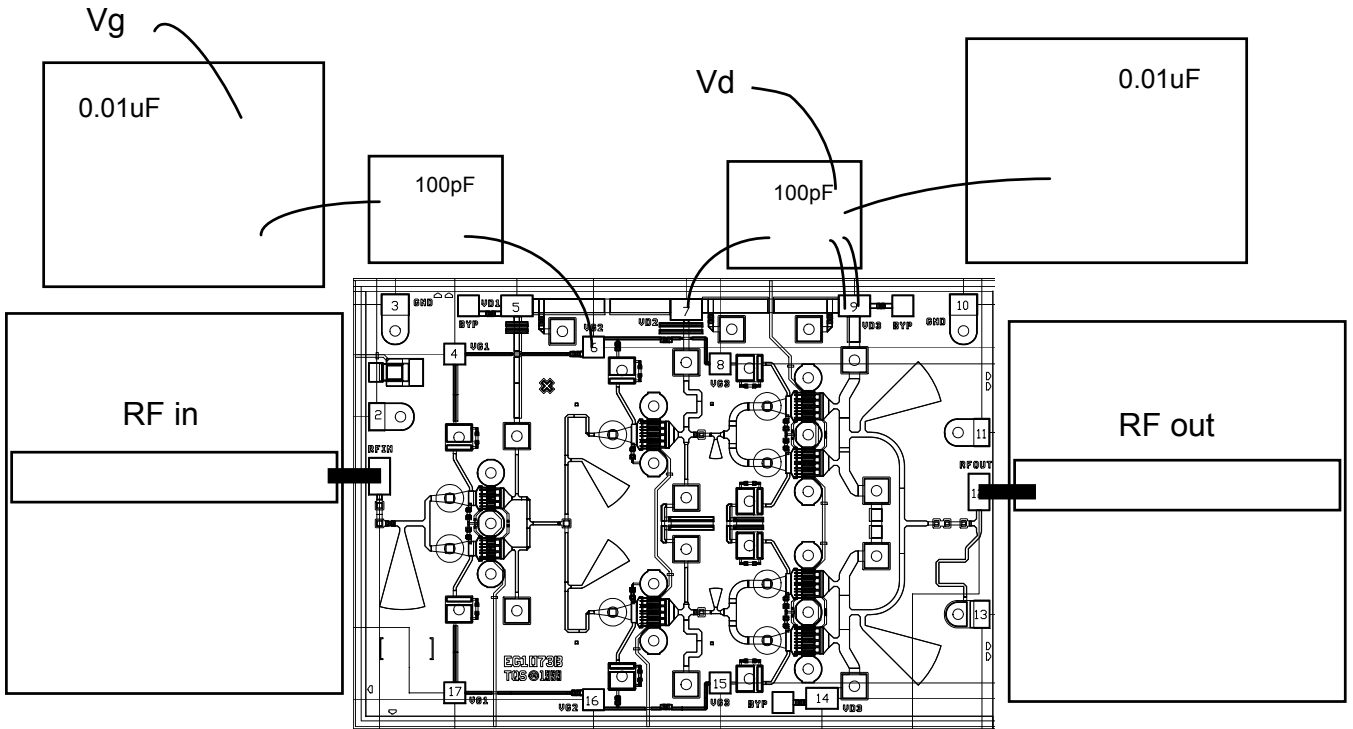

Recommended:

- Solder MMIC to carrier using AuSn 80/20
- Bond MMIC RF in and RF out with 5mil Au ribbon
- Ribbon should be as short as possible
- Bond DC Lines as shown with 1 mil bondwires

Reflow process assembly notes:

- AuSn (80/20) solder with limited exposure to temperatures at or above 300°C
- alloy station or conveyor furnace with reducing atmosphere
- no fluxes should be utilized
- coefficient of thermal expansion matching is critical for long-term reliability
- storage in dry nitrogen atmosphere

Component placement and adhesive attachment assembly notes:

- vacuum pencils and/or vacuum collets preferred method of pick up
- avoidance of air bridges during placement
- force impact critical during auto placement
- organic attachment can be used in low-power applications
- curing should be done in a convection oven; proper exhaust is a safety concern
- microwave or radiant curing should not be used because of differential heating
- coefficient of thermal expansion matching is critical

Interconnect process assembly notes:

- thermosonic ball bonding is the preferred interconnect technique
- force, time, and ultrasonics are critical parameters
- aluminum wire should not be used
- discrete FET devices with small pad sizes should be bonded with 0.0007-inch wire
- maximum stage temperature: 200°C

GaAs MMIC devices are susceptible to damage from Electrostatic Discharge. Proper precautions should be observed during handling, assembly and test.