

SBD Type :11DQ09

FEATURES

- * Miniature Size
- * Low Forward Voltage drop
- * Low Power Loss, High Efficiency
- * High Surge Capability
- * 30 Volts thru 100 Volts Types Available
- * 52mm Inside Tape Spacing Package Available

OUTLINE DRAWING

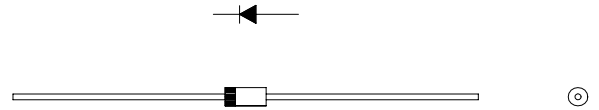

Maximum Ratings

Approx Net Weight:0.32g

Rating		Symbol	11DQ09			Unit
Repetitive Peak Reverse Voltage		V_{RRM}	90			V
Average Rectified Output Current	Without Fin or P.C.Board	I_O	1.0	$T_a=38^{\circ}C^*$	50Hz Half Sine Wave Resistive Load	A
	P.C.Board mounted		1.0	$T_a=80^{\circ}C^*$		
RMS Forward Current		$I_{F(RMS)}$	1.57			A
Surge Forward Current		I_{FSM}	40	50Hz Half Sine Wave, 1cycle, Non-repetitive		A
Operating Junction Temperature Range		T_{jw}	- 40 to + 150			$^{\circ}C$
Storage Temperature Range		T_{stg}	- 40 to + 150			$^{\circ}C$

Electrical • Thermal Characteristics

Characteristics	Symbol	Conditions	Min.	Typ.	Max.	Unit
Peak Reverse Current	I_{RM}	$T_j= 25^{\circ}C, V_{RM}= V_{RRM}$	-	-	0.5	mA
Peak Forward Voltage	V_{FM}	$T_j= 25^{\circ}C, I_{FM}= 1.0A$	-	-	0.85	V
Thermal Resistance (Junction to Ambient)	$R_{th(j-a)}$	Without Fin or P.C.Board	-	-	130	$^{\circ}C/W$
		P.C.Board mounted	-	-	81	

*:Print Lands=5x5mm,Both Sides

11DQ09 OUTLINE DRAWING (Dimensions in mm)

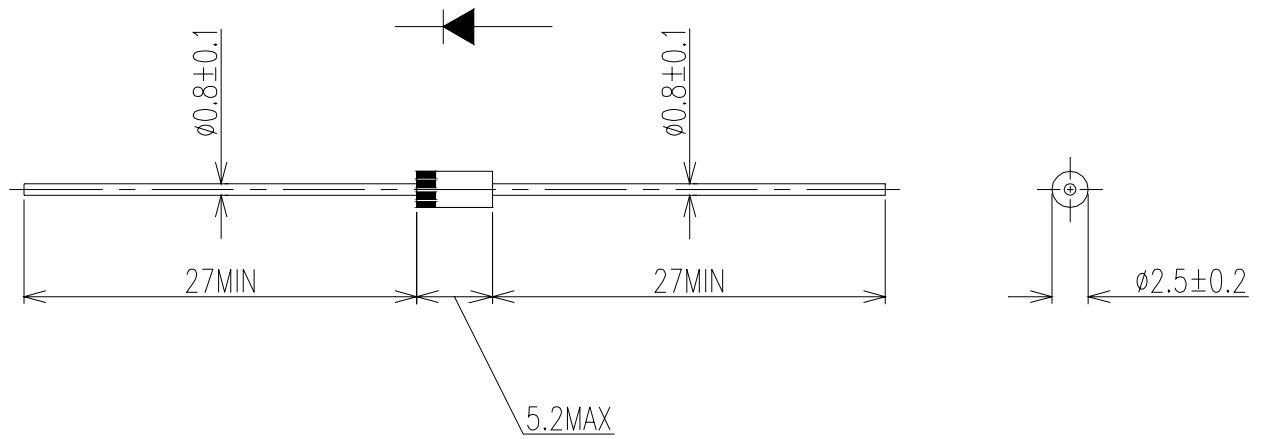

FORWARD CURRENT VS. VOLTAGE

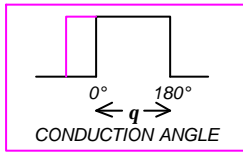
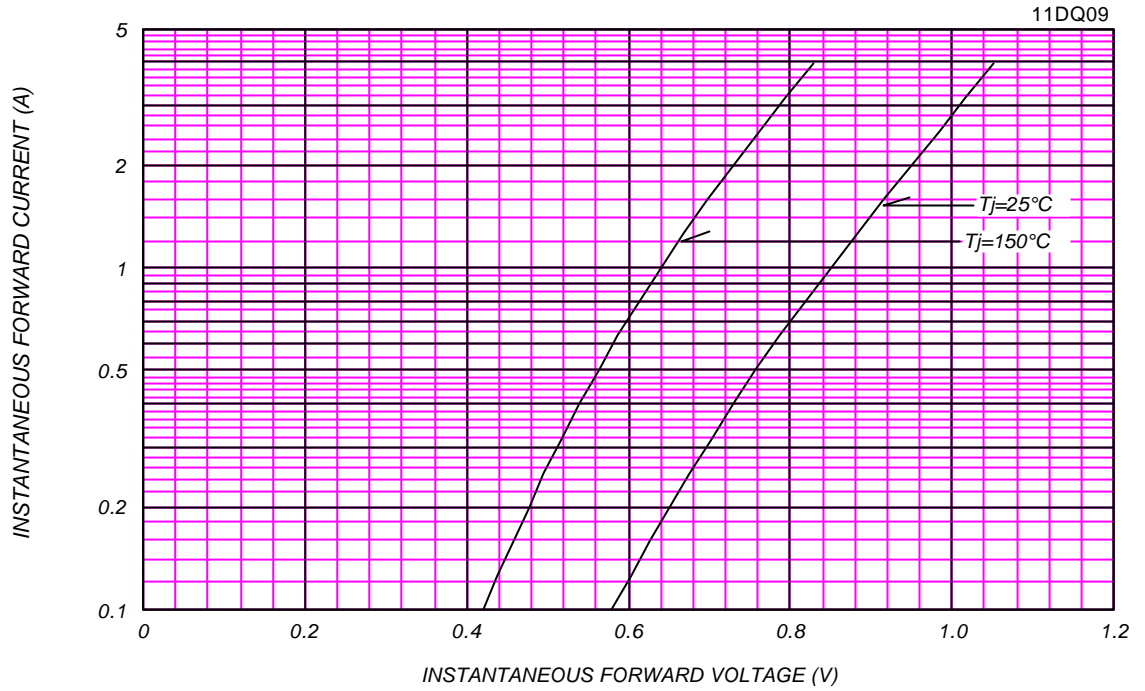

AVERAGE FORWARD POWER DISSIPATION

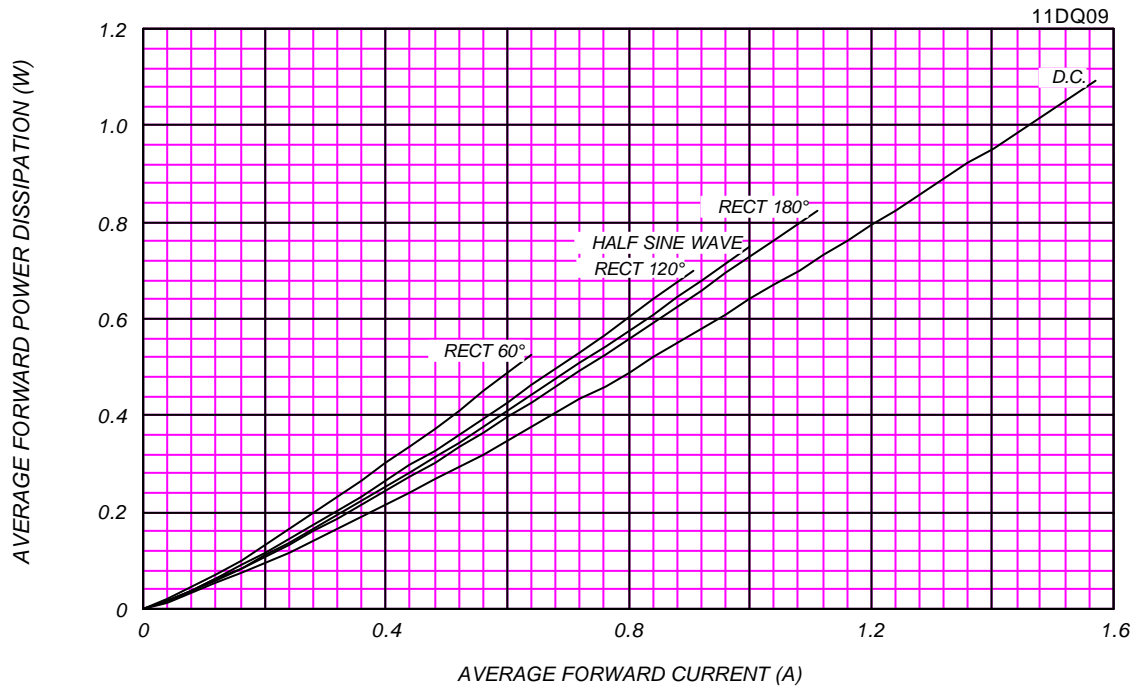

PEAK REVERSE CURRENT VS. PEAK REVERSE VOLTAGE

T_j = 150 °C

11DQ09

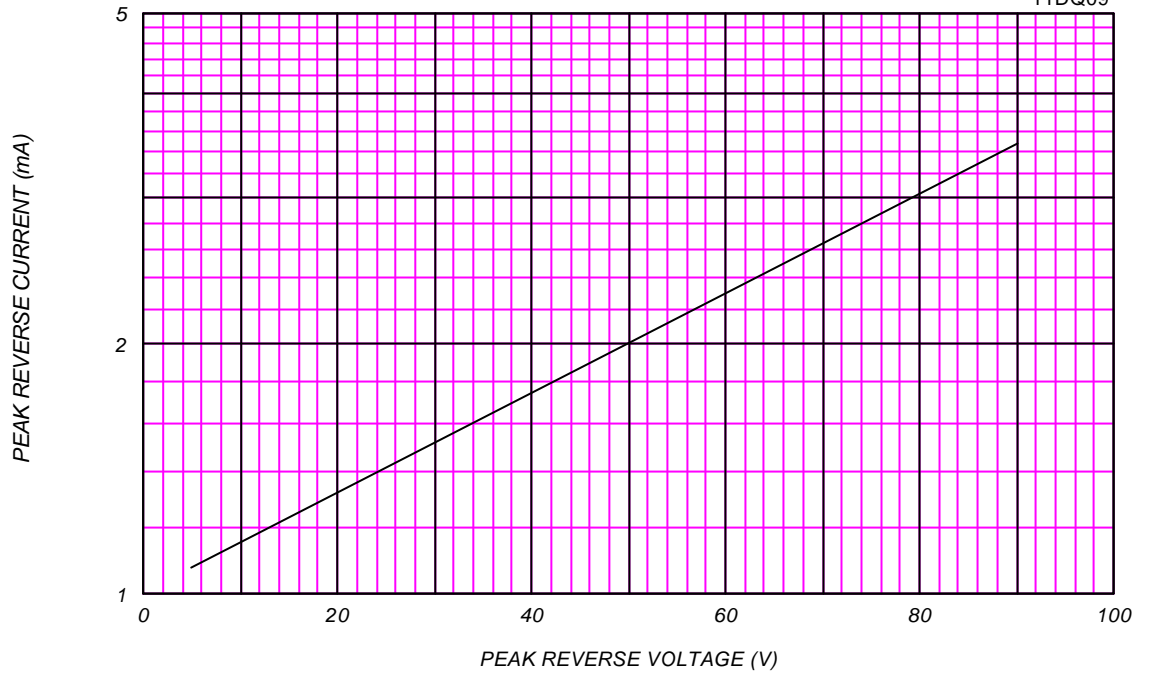

AVERAGE REVERSE POWER DISSIPATION

11DQ09

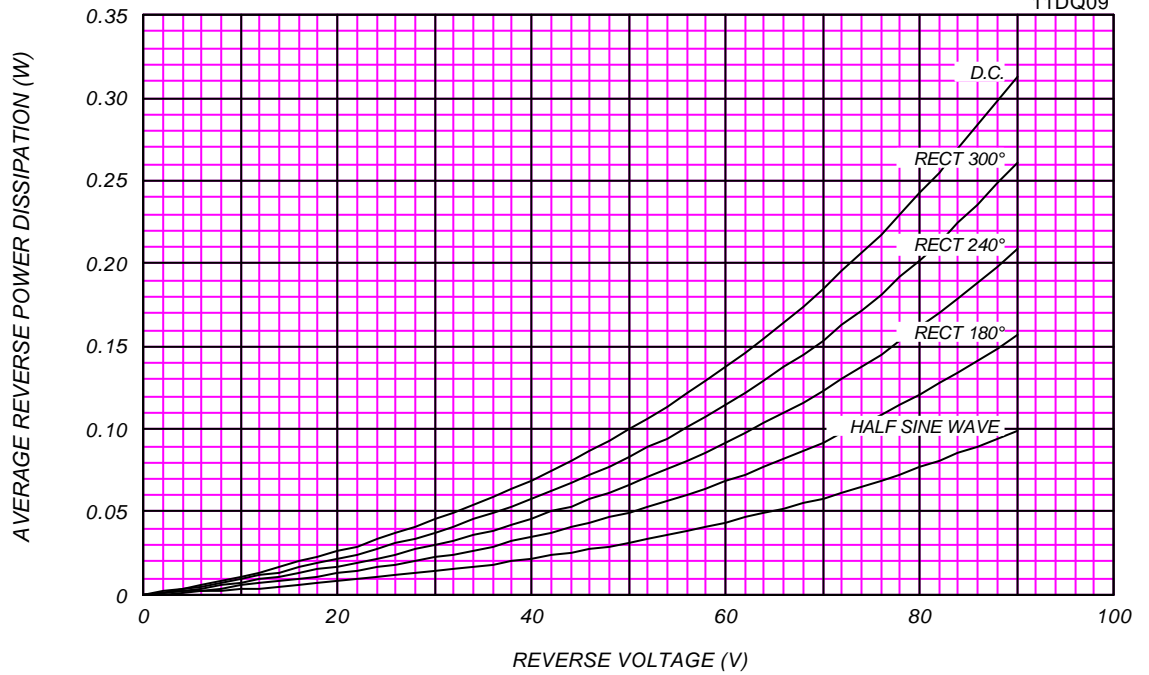

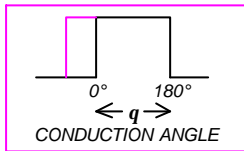

AVERAGE FORWARD CURRENT VS. AMBIENT TEMPERATURE

Without Fin or P.C. Board, $V_{RM}=90V$

11DQ09

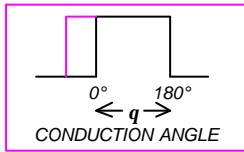
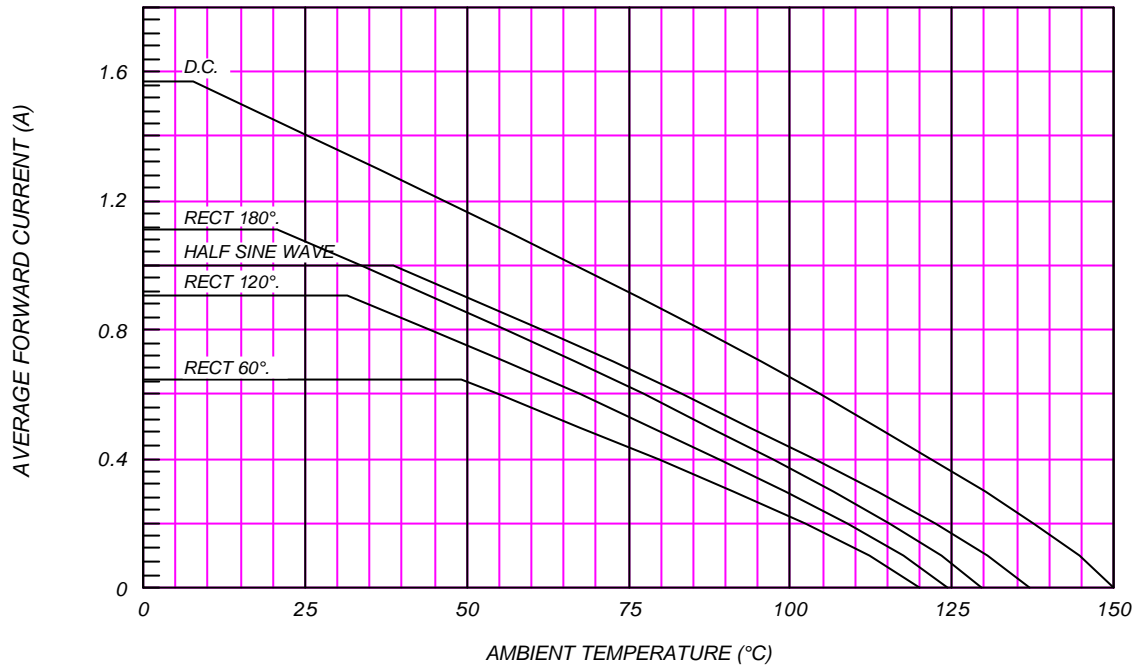

AVERAGE FORWARD CURRENT VS. AMBIENT TEMPERATURE

P.C. Board mounted ($L=8mm$, Print Land= $10\times 10mm$), $V_{RM}=90V$

11DQ09

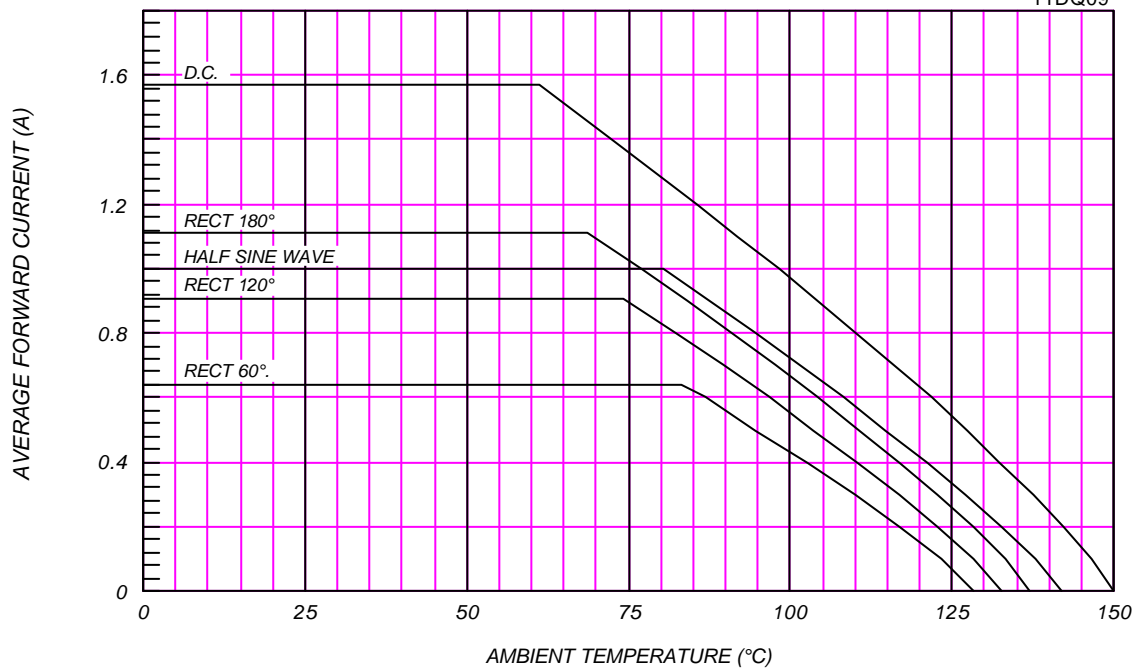

SURGE CURRENT RATINGS

f=50Hz,Half Sine Wave,Non-Repetitive,No Load

11DQ09

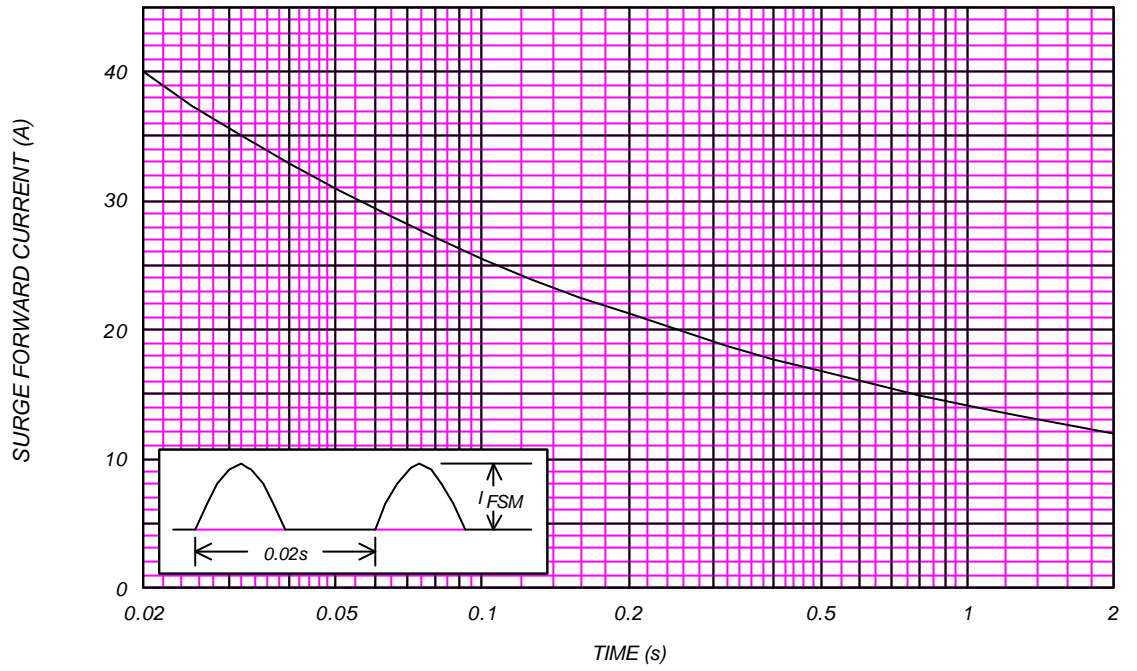

JUNCTION CAPACITANCE VS. REVERSE VOLTAGE

$T_j=25^{\circ}\text{C}$, $V_m=20\text{mV}_{\text{RMS}}$, $f=100\text{kHz}$, Typical Value

11DQ09

