

2SD1731

Silicon PNP Triple-Diffused Planar Type

Horizontal Deflection Output

■ Features

- Damper diode built-in
- Minimizes external component counts and simplifies circuitry
- High breakdown voltage, high reliability
- High speed switching
- Wide area of safety operation (ASO)

■ Absolute Maximum Ratings (Tc=25°C)

Item	Symbol	Value	Unit	
Collector-base voltage	V_{CB0}	1500	V	
Collector-emitter voltage	V_{CE5}	1500	V	
	V_{CE0}	700	V	
Emitter-base voltage	V_{EB0}	7	V	
Peak collector current	I_{CP}	18	A	
Collector current	I_C	6	A	
Base current	I_B	2.5	A	
Collector power dissipation	P_C	Tc = 25°C	100	W
		Ta = 25°C	2.5	
Junction temperature	T_J	150	°C	
Storage temperature	T_{stg}	-55 ~ +150	°C	

■ Package Dimensions

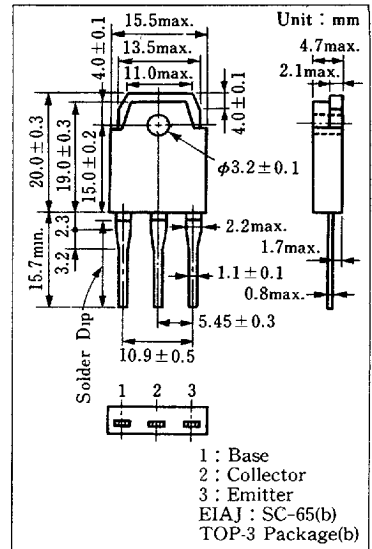

■ Inner Circuit

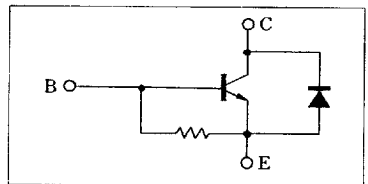

■ Electrical Characteristics (Tc=25°C)

Item	Symbol	Condition	min.	typ.	max.	Unit
Collector cutoff current	I_{CBO}	$V_{CB}=750\text{ V}, I_E=0$			10	μA
		$V_{CB}=1500\text{ V}, I_E=0$			1	mA
Emitter-base voltage	V_{EB0}	$I_L=500\text{ mA}, I_C=0$	7			V
DC current gain	h_{FE}	$V_{CE}=5\text{ V}, I_C=1\text{ A}$	5		25	
Collector-emitter saturation voltage	$V_{CE(sat)}$	$I_C=5\text{ A}, I_B=1.2\text{ A}$			8	V
Base-emitter saturation voltage	$V_{BE(sat)}$	$I_C=5\text{ A}, I_B=1.2\text{ A}$			1.5	V
Transition frequency	f_T	$V_{CE}=10\text{ V}, I_C=1\text{ A}, f=0.5\text{ MHz}$		2		MHz
Storage time (L load)	t_{stg}	$I_C=5\text{ A}, I_{B1}=1.2\text{ A}$			10	μs
Fall time (L load)	t_f	$I_{B2}=-1.2\text{ A}, L_{leak}=5\text{ H}$			0.8	μs
Storage time (R load)	t_{stg}	$I_C=5\text{ A}, I_{B1}=1\text{ A}$		1.5		μs
Fall time (R load)	t_f	$I_{B2}=-2\text{ A}, V_{CC}=200\text{ V}$		0.2		μs
Diode forward voltage	V_F	$I_C=-6\text{ A}, I_B=0$			-2.3	V

6932852 0016813 183

Panasonic

-812-

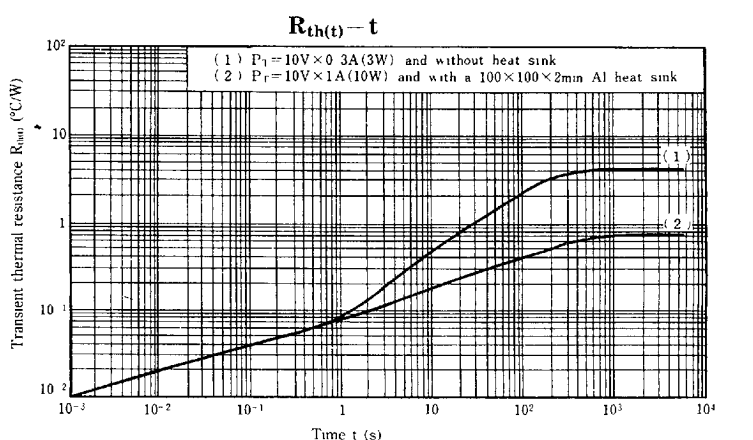
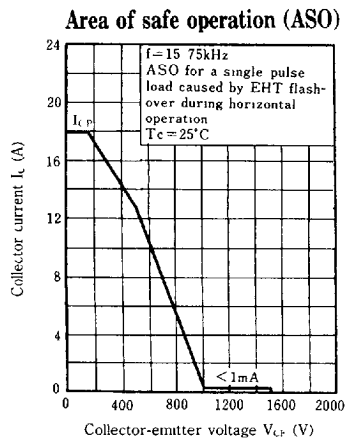
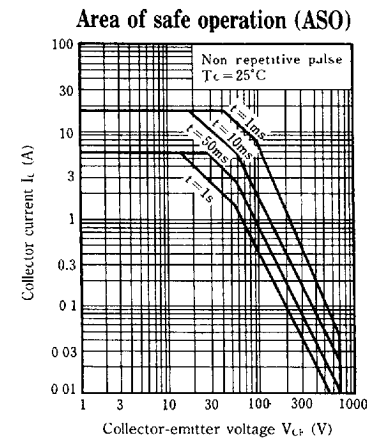
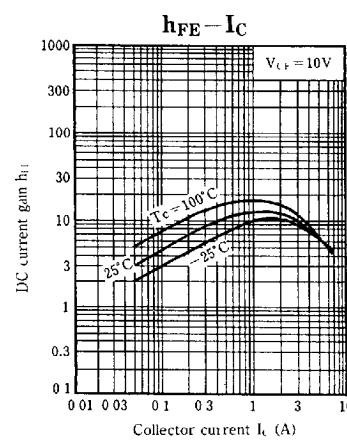
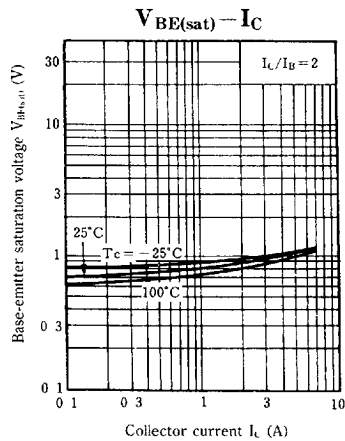
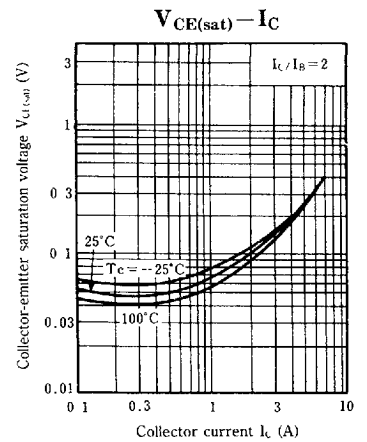
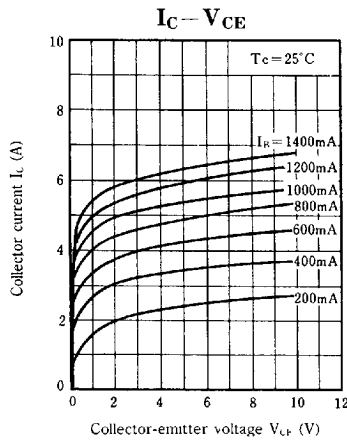
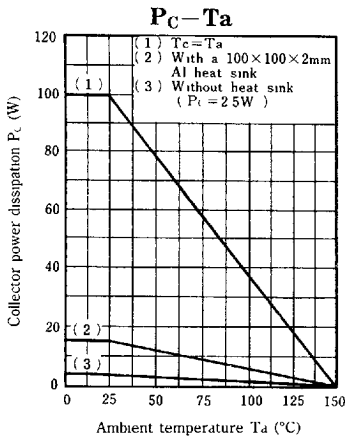

6932852 0016814 01T