

**Features**

- High Speed Programmable Logic Device  
15 ns Max Propagation Delay  
5 V  $\pm 10\%$  Operation
- Low Power CMOS Operation
- CMOS and TTL Compatible Inputs and Outputs  
10  $\mu$ A Leakage Maximum
- Reprogrammable - Tested 100% for Programmability
- High Reliability CMOS Technology  
2000 V ESD Protection  
200 mA Latchup Immunity
- Full Military, Commercial and Industrial Temperature Ranges
- Dual-In-Line and Surface Mount Packages

Speed	"L"	-15,-20	All
Temp	Com./Mil.	Com./Mil.	Others
Icc(mA)	12/15	90/100	55

**High Speed  
UV Erasable  
Programmable  
Logic Device**

**Logic Diagram**

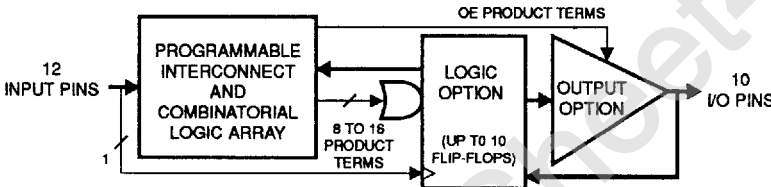

**Description**

The AT22V10 and AT22V10L are CMOS high performance EPROM-based Programmable Logic Devices (PLDs). Speeds down to 15 ns and power dissipation as low as 12 mA are offered. All speed ranges are specified over the full 5 V  $\pm 10\%$  range. All pins offer a low  $\pm 10$   $\mu$ A leakage.

The AT22V10L provides the optimum low power CMOS PLD solution, with low DC power (8 mA typical) and full CMOS output levels. The AT22V10L significantly reduces total system power and enhances system reliability.

Full CMOS output levels help reduce power in many other system components.

The AT22V10 and AT22V10L incorporate a variable product term architecture. Each output is allocated from eight to 16 product terms, which allows highly complex logic functions to be realized.

Two additional product terms are included to provide synchronous preset and asynchronous reset. These terms are common to all 10 registers. All registers are automatically cleared upon power up.

Register preload simplifies testing. A security fuse prevents unauthorized copying of programmed fuse patterns.

**Pin Configurations**

Pin Name	Function
CLK/IN	Clock and Logic Input
IN	Logic Inputs
I/O	Bidirectional Buffers
*	No Internal Connection
VCC	+5 V Supply

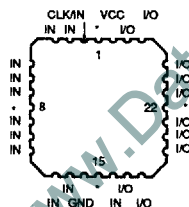
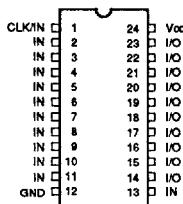

## Absolute Maximum Ratings\*

Temperature Under Bias.....	-55°C to +125°C
Storage Temperature.....	-65°C to +150°C
Voltage on Any Pin with Respect to Ground.....	-2.0 V to +7.0 V <sup>(1)</sup>
Voltage on Input Pins with Respect to Ground During Programming.....	-2.0 V to +14.0 V <sup>(1)</sup>
Programming Voltage with Respect to Ground.....	-2.0 V to +14.0 V <sup>(1)</sup>
Integrated UV Erase Dose.....	7258 W-sec/cm <sup>2</sup>

\*NOTICE: Stresses beyond those listed under "Absolute Maximum Ratings" may cause permanent damage to the device. This is a stress rating only and functional operation of the device at these or any other conditions beyond those indicated in the operational sections of this specification is not implied. Exposure to absolute maximum rating conditions for extended periods may affect device reliability.

Note:

1. Minimum voltage is -0.6 V dc which may undershoot to -2.0 V for pulses of less than 20 ns. Maximum output pin voltage is  $V_{CC}+0.75$  V dc which may overshoot to +7.0 V for pulses of less than 20 ns.

## Logic Options

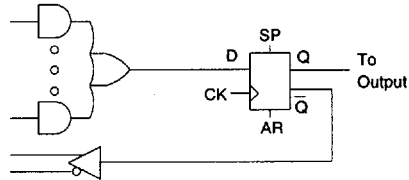
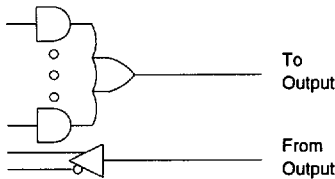

## Output Options

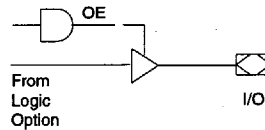
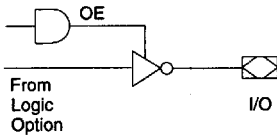

## D.C. and A.C. Operating Conditions

	Commercial AT22V10/L -15, -20, -25	Industrial AT22V10/L -15, -20, -25	Military AT22V10/L -15, -20, -25, -30
Operating Temperature (Case)	0°C - 70°C	-40°C - 85°C	-55°C - 125°C
V <sub>CC</sub> Power Supply	5 V ± 10%	5 V ± 10%	5 V ± 10%

## D.C. Characteristics

Symbol	Parameter	Condition	Min	Typ	Max	Units		
I <sub>LI</sub>	Input Load Current	V <sub>IN</sub> = -0.1 V to V <sub>CC</sub> +1 V			10	μA		
I <sub>LO</sub>	Output Leakage Current	V <sub>OUT</sub> = -0.1 V to V <sub>CC</sub> +0.1 V			10	μA		
I <sub>CC</sub>	Power Supply Current	V <sub>CC</sub> = MAX, V <sub>IN</sub> = GND, Outputs Open	AT22V10-15,-20		Com.	90	mA	
					Ind., Mil.	100	mA	
			AT22V10-25,-35 <sup>(2)</sup>			55	mA	
			AT22V10L <sup>(2)</sup>		Com.	1.7	12	mA
					Ind., Mil.	2.0	15	mA
I <sub>CC2</sub>	Clocked Power Supply Current	f = 1 MHz, V <sub>CC</sub> = MAX, Outputs Open	AT22V10L <sup>(2)</sup>		Com.	15	mA	
					Ind., Mil.	20	mA	
I <sub>OS</sub> (1)	Output Short Circuit Current	V <sub>OUT</sub> = 0.5 V				-90	mA	
V <sub>IL</sub>	Input Low Voltage		-0.6		0.8	V		
V <sub>IH</sub>	Input High Voltage		2.0		V <sub>CC</sub> +0.75	V		
V <sub>OL</sub>	Output Low Voltage	V <sub>IN</sub> = V <sub>IH</sub> or V <sub>IL</sub> , V <sub>CC</sub> = MIN	I <sub>OL</sub> = 16 mA	Com., Ind.		0.5	V	
			I <sub>OL</sub> = 12 mA	Mil.		0.5	V	
			I <sub>OL</sub> = 24 mA	Com.		0.8	V	
V <sub>OH</sub>	Output High Voltage	V <sub>IN</sub> =V <sub>IH</sub> or V <sub>IL</sub> , V <sub>CC</sub> =MIN	I <sub>OH</sub> = -100 μA		V <sub>CC</sub> -0.3		V	
			I <sub>OH</sub> = -4.0 mA		2.4		V	

Notes: 1. Not more than one output at a time should be shorted. 2. See I<sub>CC</sub> vs. Frequency curves in the back of this data sheet.  
Duration of short circuit test should not exceed 30 sec.

## A.C. Characteristics, Commercial and Industrial

Symbol	Parameter	AT22V10-15			AT22V10/L-20			AT22V10/L-25			Units
		Min	Typ	Max	Min	Typ	Max	Min	Typ	Max	
t <sub>PD</sub>	Input or Feedback to Non-Registered Output		10	15		12	20		15	25	ns
t <sub>EA</sub>	Input to Output Enable		10	15			20		15	25	ns
t <sub>ER</sub>	Input to Output Disable		10	15			20		15	25	ns
t <sub>CF</sub>	Clock to Feedback	0	1	2.5	0	4	8	0	5	10	ns
t <sub>CO</sub>	Clock to Output	0	7	10	0	8	12	0	10	15	ns
t <sub>S</sub>	Input or Feedback Setup Time	10	8		12	8		15	12		ns
t <sub>H</sub>	Hold Time		0			0			0		ns
t <sub>P</sub>	Clock Period		12			20			24		ns
t <sub>W</sub>	Clock Width		6			10			12		ns
F <sub>MAX</sub>	External Feedback 1/(t <sub>S</sub> +t <sub>CO</sub> )			50.0			41.6			33.3	MHz
	Internal Feedback 1/(t <sub>S</sub> + t <sub>CF</sub> )			80.0			50.0			40.0	MHz
	No Feedback 1/(t <sub>P</sub> )			83.3			50.0			41.6	MHz
t <sub>AW</sub>	Asynchronous Reset Width	15	8		20	9		25	10		ns
t <sub>AR</sub>	Asynchronous Reset, Synchronous Preset, Recovery Time	15	8		20	12		25	15		ns
t <sub>AP</sub>	Asynchronous Reset to Registered Output Reset		12	20		15	22		18	25	ns





## A.C. Waveforms <sup>(1)</sup>

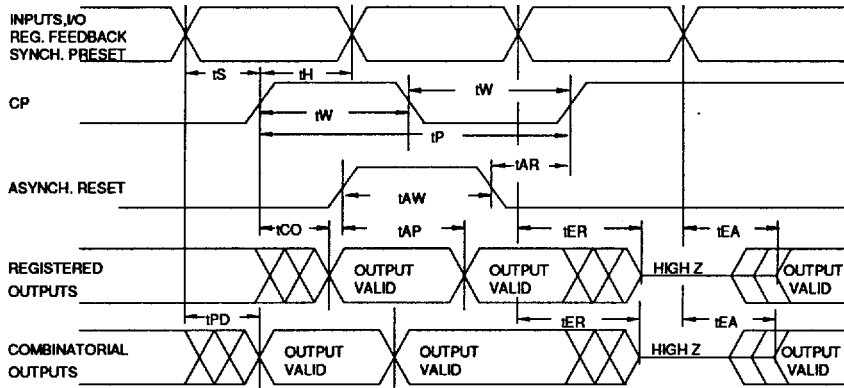

Note: 1. Timing measurement reference is 1.5 V. Input AC driving levels are 0.0 V and 3.0 V, unless otherwise specified.

## A.C. Characteristics, Military

Symbol	Parameter	AT22V10-15			AT22V10/L-20			AT22V10/L-25			AT22V10/L-30			Units
		Min	Typ	Max	Min	Typ	Max	Min	Typ	Max	Min	Typ	Max	
$t_{PD}$	Input or Feedback to Non-Registered Output		10	15		12	20		15	25		20	30	ns
$t_{EA}$	Input to Output Enable		10	15			20		15	25		20	30	ns
$t_{ER}$	Input to Output Disable		10	15			20		15	25		20	30	ns
$t_{CF}$	Clock to Feedback	0	1	2.5	0	4	8	0	5	10	0	10	15	ns
$t_{CO}$	Clock to Output	0	7	10	0	8	15	0	10	15	0	12	20	ns
$t_{SF}$	Feedback Setup Time	10	8		12	10		15	12		18	15		ns
$t_S$	Input Setup Time	10	8		17	14		18	15		20	15		ns
$t_H$	Hold Time	0			0			0			0			ns
$t_P$	Clock Period	12			20			24			30			ns
$t_W$	Clock Width	6			10			12			15			ns
FMAX	External Feedback $1/(t_S + t_{CO})$			50.0			31.2			30.3			25.0	MHz
	Internal Feedback $1/(t_{SF} + t_{CF})$			80.0			50.0			40.0			30.0	MHz
	No Feedback $1/t_P$			83.3			50.0			41.6			33.3	MHz
$t_{AW}$	Asynchronous Reset Width	15	8		20	9		25	10		30	15		ns
$t_{AR}$	Asynchronous Reset Recovery Time	15	8		20	12		25	15		30	18		ns
$t_{AP}$	Asynchronous Reset to Registered Output Reset		12	20		15	22		18	25		20	30	ns

## Input Test Waveforms and Measurement Levels

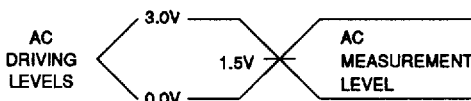

$t_R, t_F < 5$  ns (10% to 90%)

## Output Test Loads:

### Commercial

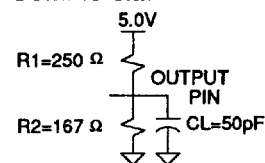

### Military

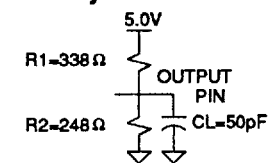

Functional Logic Diagram AT22V10/L

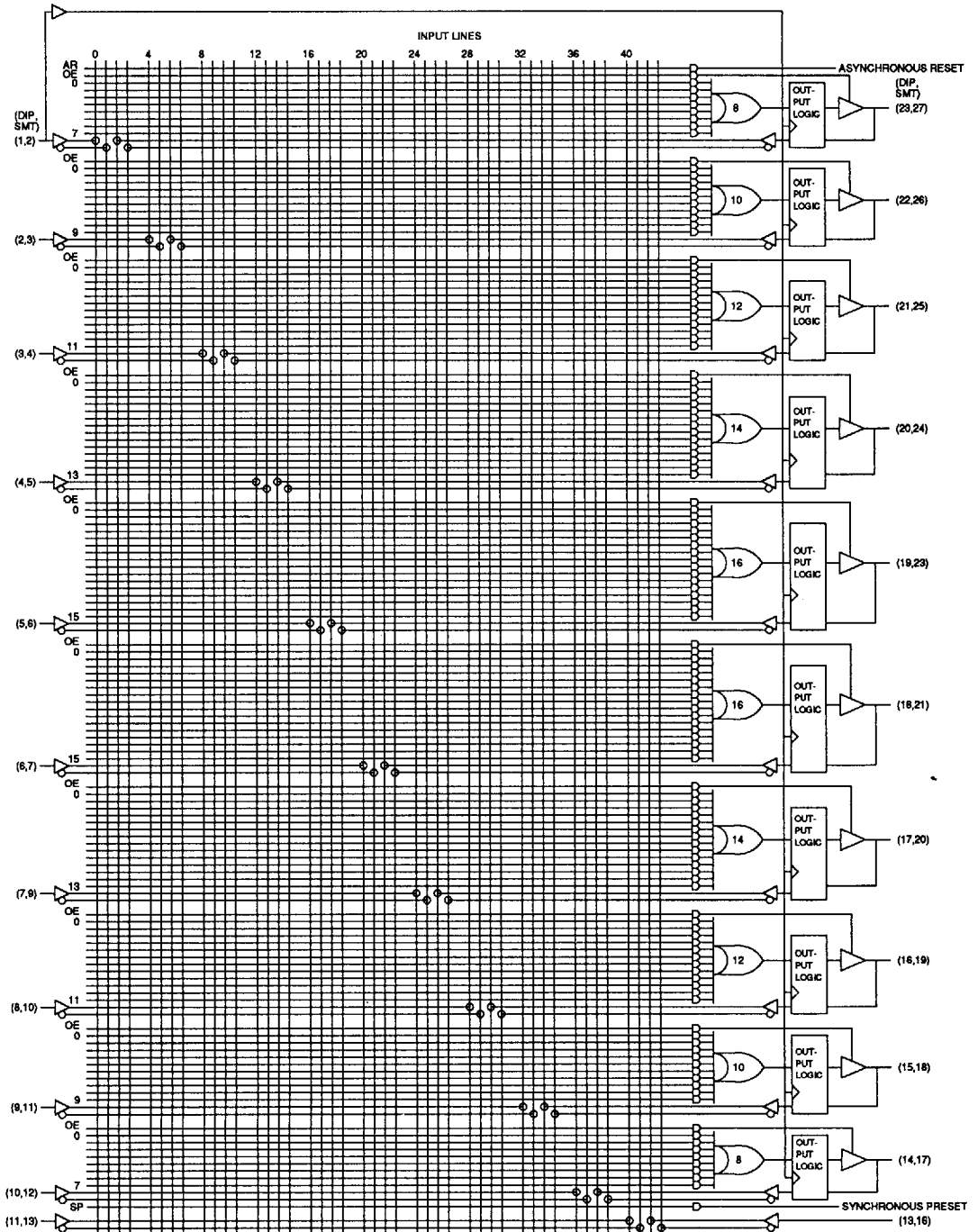

1



## Preload of Registered Outputs

The registers in the AT22V10 and AT22V10L are provided with circuitry to allow loading of each register asynchronously with either a high or a low. This feature will simplify testing since any state can be forced into the registers to control test sequencing. A  $V_{IH}$  level on the I/O pin will force the register high; a  $V_{IL}$  will force it low, independent of the polarity bit (CO) setting. The preload state is entered by placing an 11.5-V to 13-V signal on pin 8 on DIPs, and pin 10 on SMPs. When the clock pin is pulsed high, the data on the I/O pins is placed into the ten registers.

Level forced on registered output pin during preload cycle	Register state after cycle
$V_{IH}$	High
$V_{IL}$	Low

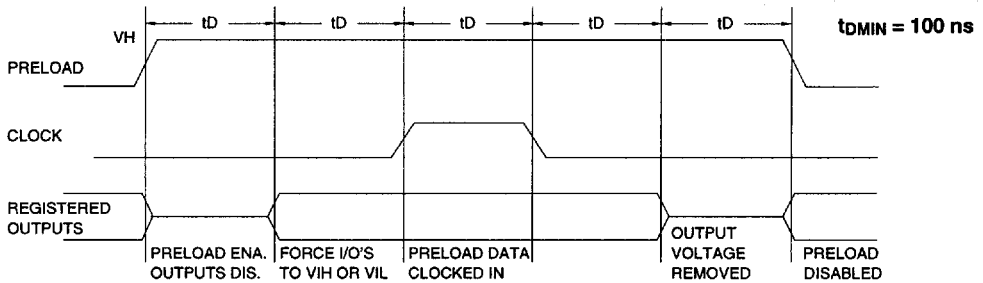

## Power Up Reset

The registers in the AT22V10 and AT22V10L are designed to reset during power up. At a point delayed slightly from  $V_{CC}$  crossing 3.8 V, all registers will be reset to the low state. The output state will depend on the polarity of the output buffer.

This feature is critical for state machine initialization. However, due to the asynchronous nature of reset and the uncertainty of how  $V_{CC}$  actually rises in the system, the following conditions are required:

- 1) The  $V_{CC}$  rise must be monotonic,
- 2) After reset occurs, all input and feedback setup times must be met before driving the clock pin high, and
- 3) The clock must remain stable during  $t_{PR}$ .

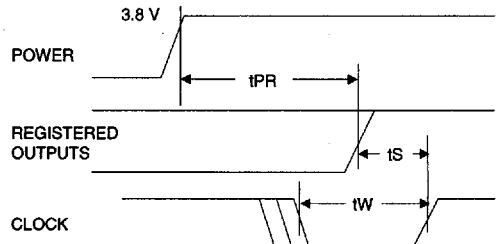

Parameter	Description	Min	Typ	Max	Units
$t_{PR}$	Power-Up Reset Time		600	1000	ns

## Pin Capacitance $(f = 1 \text{ MHz}, T = 25^\circ\text{C})^{(1)}$

	Typ	Max	Units	Conditions
$C_{IN}$	5	8	pF	$V_{IN} = 0 \text{ V}$
$C_{OUT}$	6	8	pF	$V_{OUT} = 0 \text{ V}$

Note: 1. Typical values for nominal supply voltage. This parameter is only sampled and is not 100% tested.

## Erase Characteristics

The entire fuse array of an AT22V10 or AT22V10L is erased after exposure to ultraviolet light at a wavelength of 2537 Å. Complete erasure is assured after a minimum of 20 minutes exposure using 12,000  $\mu\text{W}/\text{cm}^2$  intensity lamps spaced one inch away from the chip. Minimum erase time for lamps at other in-

tensity ratings can be calculated from the minimum integrated erasure dose of 15  $\text{W}\cdot\text{sec}/\text{cm}^2$ . To prevent unintentional erasure, an opaque label is recommended to cover the clear window on any UV erasable PLD which will be subjected to continuous fluorescent indoor lighting or sunlight.

## SUPPLY CURRENT vs. INPUT FREQUENCY

AT22V10 (TA = 25C, VCC = 5V)

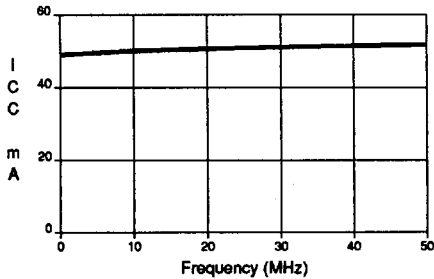

## SUPPLY CURRENT vs. INPUT FREQUENCY

AT22V10L (TA = 25C, VCC = 5V)

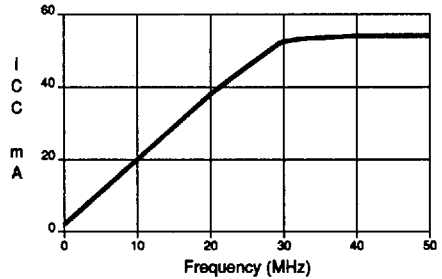

## NORMALIZED SUPPLY CURRENT vs. SUPPLY VOLTAGE

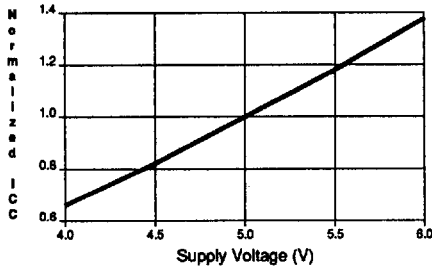

## NORMALIZED ICC vs. AMBIENT TEMP.

f = 30 MHz

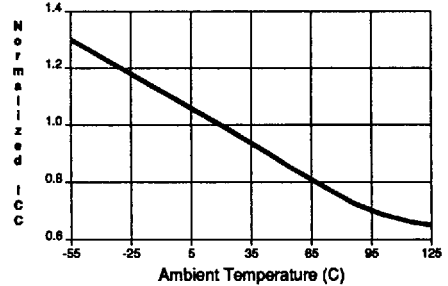

## OUTPUT SINK CURRENT vs. SUPPLY VOLTAGE (VOL = 0.5V)

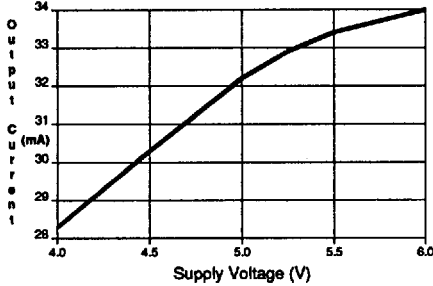

## OUTPUT SINK CURRENT vs. OUTPUT VOLTAGE (TA = 25C, VCC = 5V)

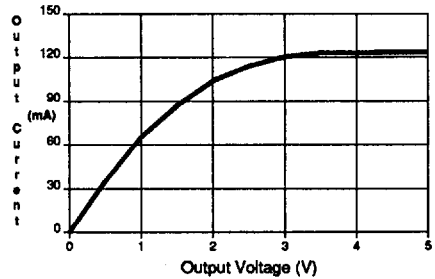

## OUTPUT SOURCE CURRENT vs. SUPPLY VOLTAGE (VOH = 2.4V)

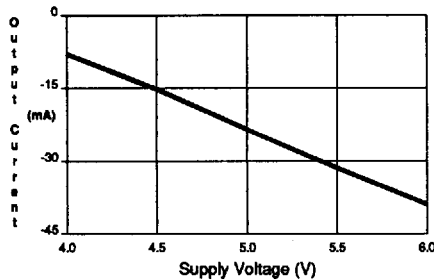

## OUTPUT SOURCE CURRENT vs. OUTPUT VOLTAGE (TA = 25C, VCC = 5V)

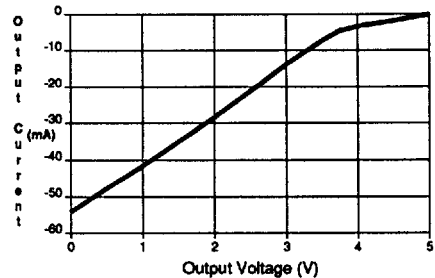



NORMALIZED TPD  
vs. SUPPLY VOLTAGE

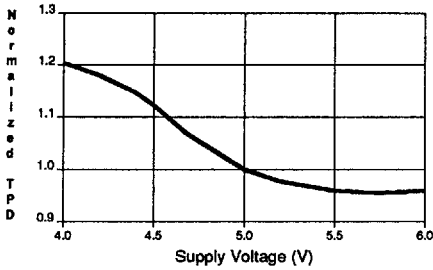

NORMALIZED TPD  
vs. TEMPERATURE

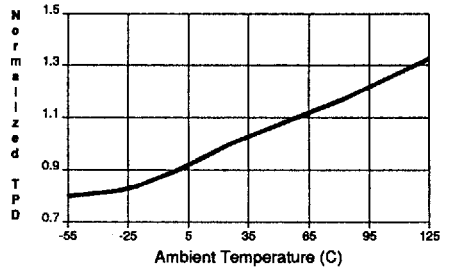

NORMALIZED TCO  
vs. SUPPLY VOLTAGE

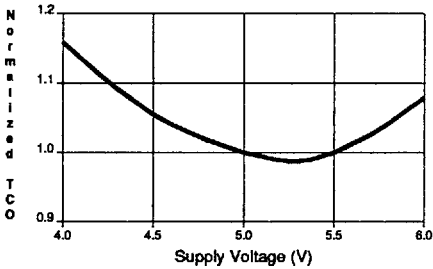

NORMALIZED TCO  
vs. TEMPERATURE

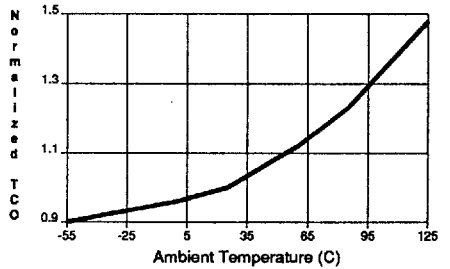

NORMALIZED TS  
vs. SUPPLY VOLTAGE

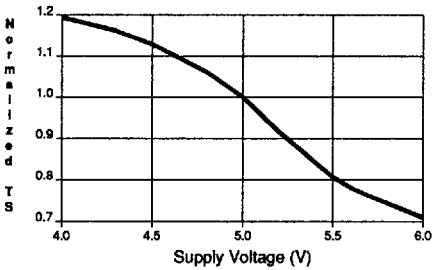

NORMALIZED TS  
vs. TEMPERATURE

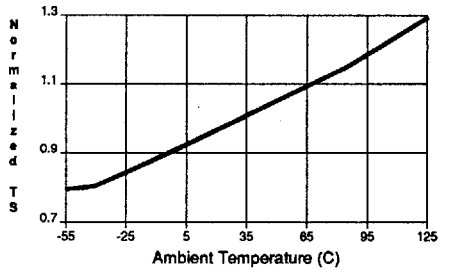

DELTA TPD vs. OUTPUT LOADING  
(VCC = 4.5V, OUTPUT LOAD = COMMERCIAL)

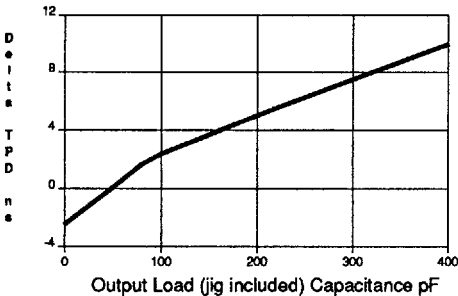

DELTA TCO vs. OUTPUT LOADING  
(VCC = 4.5V, OUTPUT LOAD = COMMERCIAL)

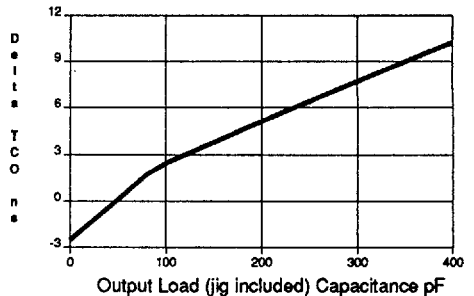



Ordering Information

tpd (ns)	ts (ns)	tco (ns)	Ordering Code	Package	Operation Range
15	10	10	AT22V10-15DC AT22V10-15GC AT22V10-15JC AT22V10-15KC AT22V10-15LC AT22V10-15NC AT22V10-15PC AT22V10-15SC	24DW3 24D3 28J 28KW 28LW 28L 24P3 24S	Commercial (0°C to 70°C)
			AT22V10-15DI AT22V10-15GI AT22V10-15JI AT22V10-15KI AT22V10-15LI AT22V10-15NI AT22V10-15PI AT22V10-15SI	24DW3 24D3 28J 28KW 28LW 28L 24P3 24S	Industrial (-40°C to 85°C)
			AT22V10-15DM AT22V10-15GM AT22V10-15KM AT22V10-15LM AT22V10-15NM	24DW3 24D3 28KW 28LW 28L	Military (-55°C to 125°C)
			AT22V10-15DM/883 AT22V10-15GM/883 AT22V10-15KM/883 AT22V10-15LM/883 AT22V10-15NM/883	24DW3 24D3 28KW 28LW 28L	Military/883C (-55°C to 125°C) Class B, Fully Compliant
20	12	15	AT22V10-20DC AT22V10-20GC AT22V10-20JC AT22V10-20KC AT22V10-20LC AT22V10-20NC AT22V10-20PC AT22V10-20SC	24DW3 24D3 28J 28KW 28LW 28L 24P3 24S	Commercial (0°C to 70°C)
			AT22V10-20DI AT22V10-20GI AT22V10-20JI AT22V10-20KI AT22V10-20LI AT22V10-20NI AT22V10-20PI AT22V10-20SI	24DW3 24D3 28J 28KW 28LW 28L 24P3 24S	Industrial (-40°C to 85°C)
20	17	15	AT22V10-20DM AT22V10-20GM AT22V10-20KM AT22V10-20LM AT22V10-20NM	24DW3 24D3 28KW 28LW 28L	Military (-55°C to 125°C)

1





## Ordering Information

t <sub>PD</sub> (ns)	t <sub>s</sub> (ns)	t <sub>CO</sub> (ns)	Ordering Code	Package	Operation Range
20	17	15	AT22V10-20DM/883 AT22V10-20GM/883 AT22V10-20KM/883 AT22V10-20LM/883 AT22V10-20NM/883	24DW3 24D3 28KW 28LW 28L	Military/883C (-55°C to 125°C) Class B, Fully Compliant
25	15	15	AT22V10-25DC AT22V10-25GC AT22V10-25JC AT22V10-25KC AT22V10-25LC AT22V10-25NC AT22V10-25PC AT22V10-25SC	24DW3 24D3 28J 28KW 28LW 28L 24P3 24S	Commercial (0°C to 70°C)
			AT22V10-25DI AT22V10-25GI AT22V10-25JI AT22V10-25KI AT22V10-25LI AT22V10-25NI AT22V10-25PI AT22V10-25SI	24DW3 24D3 28J 28KW 28LW 28L 24P3 24S	Industrial (-40°C to 85°C)
25	18	15	AT22V10-25DM AT22V10-25GM AT22V10-25KM AT22V10-25LM AT22V10-25NM	24DW3 24D3 28KW 28LW 28L	Military (-55°C to 125°C)
			AT22V10-25DM/883 AT22V10-25GM/883 AT22V10-25KM/883 AT22V10-25LM/883 AT22V10-25NM/883	24DW3 24D3 28KW 28LW 28L	Military/883C (-55°C to 125°C) Class B, Fully Compliant
30	20	20	AT22V10-30DM AT22V10-30GM AT22V10-30KM AT22V10-30LM AT22V10-30NM	24DW3 24D3 28KW 28LW 28L	Military (-55°C to 125°C)
			AT22V10-30DM/883 AT22V10-30GM/883 AT22V10-30KM/883 AT22V10-30LM/883 AT22V10-30NM/883	24DW3 24D3 28KW 28LW 28L	Military/883C (-55°C to 125°C) Class B, Fully Compliant
20	17	15	5962-87539 04 LX 5962-87539 04 3X	24DW3 28LW	Military/883C (-55°C to 125°C) Class B, Fully Compliant
25	18	15	5962-87539 01 LX 5962-87539 01 3X	24DW3 28LW	Military/883C (-55°C to 125°C) Class B, Fully Compliant

**Ordering Information**

tpD (ns)	ts (ns)	tco (ns)	Ordering Code	Package	Operation Range
30	20	20	5962-87539 02 LX 5962-87539 02 3X	24DW3 28LW	Military/883C (-55°C to 125°C) Class B, Fully Compliant
15	10	10	5962-88670 05 LX 5962-88670 05 3X	24D3 28L	Military/883C (-55°C to 125°C) Class B, Fully Compliant
20	17	15	5962-88670 04 LX 5962-88670 04 3X	24D3 28L	Military/883C (-55°C to 125°C) Class B, Fully Compliant
25	18	15	5962-88670 01 LX 5962-88670 01 3X	24D3 28L	Military/883C (-55°C to 125°C) Class B, Fully Compliant
30	20	20	5962-88670 02 LX 5962-88670 02 3X	24D3 28L	Military/883C (-55°C to 125°C) Class B, Fully Compliant

1





## Ordering Information

tpd (ns)	ts (ns)	tco (ns)	Ordering Code	Package	Operation Range
20	12	15	AT22V10L-20DC AT22V10L-20GC AT22V10L-20JC AT22V10L-20KC AT22V10L-20LC AT22V10L-20NC AT22V10L-20PC AT22V10L-20SC	24DW3 24D3 28J 28KW 28LW 28L 24P3 24S	Commercial (0°C to 70°C)
			AT22V10L-20DI AT22V10L-20GI AT22V10L-20JI AT22V10L-20KI AT22V10L-20LI AT22V10L-20NI AT22V10L-20PI AT22V10L-20SI	24DW3 24D3 28J 28KW 28LW 28L 24P3 24S	Industrial (-40°C to 85°C)
20	17	15	AT22V10L-20DM AT22V10L-20GM AT22V10L-20KM AT22V10L-20LM AT22V10L-20NM	24DW3 24D3 28KW 28LW 28L	Military (-55°C to 125°C)
			AT22V10L-20DM/883 AT22V10L-20GM/883 AT22V10L-20KM/883 AT22V10L-20LM/883 AT22V10L-20NM/883	24DW3 24D3 28KW 28LW 28L	Military/883C (-55°C to 125°C) Class B, Fully Compliant
25	15	15	AT22V10L-25DC AT22V10L-25GC AT22V10L-25JC AT22V10L-25KC AT22V10L-25LC AT22V10L-25NC AT22V10L-25PC AT22V10L-25SC	24DW3 24D3 28J 28KW 28LW 28L 24P3 24S	Commercial (0°C to 70°C)
			AT22V10L-25DI AT22V10L-25GI AT22V10L-25JI AT22V10L-25KI AT22V10L-25LI AT22V10L-25NI AT22V10L-25PI AT22V10L-25SI	24DW3 24D3 28J 28KW 28LW 28L 24P3 24S	Industrial (-40°C to 85°C)
25	18	15	AT22V10L-25DM AT22V10L-25GM AT22V10L-25KM AT22V10L-25LM AT22V10L-25NM	24DW3 24D3 28KW 28LW 28L	Military (-55°C to 125°C)

## Ordering Information

t <sub>PD</sub> (ns)	t <sub>s</sub> (ns)	t <sub>CO</sub> (ns)	Ordering Code	Package	Operation Range
25	18	15	AT22V10L-25DM/883 AT22V10L-25GM/883 AT22V10L-25KM/883 AT22V10L-25LM/883 AT22V10L-25NM/883	24DW3 24D3 28KW 28LW 28L	Military/883C (-55°C to 125°C) Class B, Fully Compliant
30	20	20	AT22V10L-30DM AT22V10L-30GM AT22V10L-30KM AT22V10L-30LM AT22V10L-30NM	24DW3 24D3 28KW 28LW 28L	Military (-55°C to 125°C)
			AT22V10L-30DM/883 AT22V10L-30GM/883 AT22V10L-30KM/883 AT22V10L-30LM/883 AT22V10L-30NM/883	24DW3 24D3 28KW 28LW 28L	Military/883C (-55°C to 125°C) Class B, Fully Compliant
20	17	15	5962-88724 04 LX 5962-88724 04 3X	24DW3 28L	Military/883C (-55°C to 125°C) Class B, Fully Compliant
25	18	15	5962-88724 01 LX 5962-88724 01 3X	24DW3 28LW	Military/883C (-55°C to 125°C) Class B, Fully Compliant
30	20	20	5962-88724 02 LX 5962-88724 02 3X	24DW3 28LW	Military/883C (-55°C to 125°C) Class B, Fully Compliant
20	17	15	5962-89755 04 LX 5962-89755 04 3X	24D3 28L	Military/883C (-55°C to 125°C) Class B, Fully Compliant
25	18	15	5962-89755 01 LX 5962-89755 01 3X	24D3 28L	Military/883C (-55°C to 125°C) Class B, Fully Compliant
30	20	20	5962-89755 02 LX 5962-89755 02 3X	24D3 28L	Military/883C (-55°C to 125°C) Class B, Fully Compliant

### Package Type

<b>24DW3</b>	24 Lead, 0.300" Wide, Windowed, Ceramic Dual Inline Package (Cerdip)
<b>24D3</b>	24 Lead, 0.300" Wide, Non-Windowed (OTP), Ceramic Dual Inline Package (Cerdip)
<b>28J</b>	28 Lead, Plastic J-Leaded Chip Carrier OTP (PLCC)
<b>28KW</b>	28 Lead, Windowed, Ceramic J-Leaded Chip Carrier (JLCC)
<b>28LW</b>	28 Pad, Windowed, Ceramic Leadless Chip Carrier (LCC)
<b>28L</b>	28 Pad, Non-Windowed, Ceramic Leadless Chip Carrier OTP (LCC)
<b>24P3</b>	24 Lead, 0.300" Wide, Plastic Dual Inline Package OTP (PDIP)
<b>24S</b>	24 Lead, 0.300" Wide, Plastic Gull Wing Small Outline OTP (SOIC)

