

GPS Baseband LSI

Description

The CXD2956AGL-1 is a dedicated LSI for the GPS (Global Positioning System), satellite-based location measurement system.

Compared with conventional methods, position detection time and sensitivity are substantially improved with the use of an advanced signal processing scheme.

Although package sizes differ, the CXD2956AGL-1 has realized compatibility with a foot pattern to the CXD2963GH.

This LSI used together with the Sony GPS RF down converter IC enables the configuration of a 2-chip system capable of measuring its position anywhere on the globe. The CXD2956AGL-1 is ideal for use in automotive, cellular handset, handheld navigation, mobile computing and other location-based applications.

Features

- 12-channel GPS receiver capable of simultaneously receiving 12 satellites
- Reception frequency: 1575.42MHz (L1 band, CA code)
- Reference clock (TCXO) frequency: 18.414MHz (GPS, Sony compatible),
- 32-bit RISC CPU (ARM7TDMI)
- 288K-byte Program ROM
- 72K-byte Data RAM
Power is supplied only to 8K-byte Data RAM while in backup mode.
- System power management
- 1-channel UART
- Internal RTC (Real Time Clock)
- 10-bit successive approximation system A/D converter
- All-in-view positioning
- Communication format: Supports NMEA-0183
- Supports DGPS (optional)
Conforms to RTCM SC-104 Ver. 2.1 and DARC
- 1 PPS output
- Supports assisted-GPS for cellular (optional)

Structure

Silicon gate CMOS IC

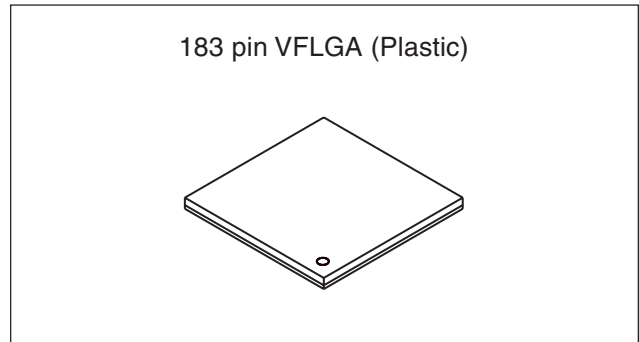

Absolute Maximum Ratings

• Supply voltage I/O	IOV _{DD}	-0.5 to +4.6	V
• Supply voltage core	CV _{DD}	-0.5 to +2.5	V
• Input voltage	V _I	-0.5 to +6	V
• Output voltage	V _O	-0.5 to +6	V
• Operating temperature	T _{opr}	-40 to +85	°C
• Storage temperature	T _{stg}	-50 to +150	°C

Recommended Operating Conditions

• Supply voltage I/O	IOV _{DD}	3.0 to 3.6	V
* Under operation with internal ROM, using no external expansion bus: IOV _{DD} 2.6 to 3.6V			
* Under operation in backup mode: BKUPIOV _{DD} 2.5 (Min.) V			
• Supply voltage core	CV _{DD}	1.62 to 1.98	V
• Operating temperature	T _{opr}	-40 to +85	°C

Input/Output Pin Capacitance

• Input capacitance	C _{IN}	9 (Max.)	pF
• Output capacitance	C _{OUT}	11 (Max.)	pF
• I/O capacitance	C _{I/O}	11 (Max.)	pF

Sony reserves the right to change products and specifications without prior notice. This information does not convey any license by any implication or otherwise under any patents or other right. Application circuits shown, if any, are typical examples illustrating the operation of the devices. Sony cannot assume responsibility for any problems arising out of the use of these circuits.

Performance

- Tracking sensitivity: -152dBm (average) or less
- Acquisition sensitivity: -139dBm (average) or less in normal mode
-150dBm (average) or less in high sensitivity mode
 - * Reference data using the Sony's reference board when using both an antenna of 25dBi gain and a RF amplifier with $NF \leq 2\text{dB}$, 25dB gain.
- TTFF (Time to First Fix):
Time until initial position measurement after power-on with the following conditions:
 - Cold Start (without both ephemeris and almanac time): 50s (average) / 60s (95% possibility)
 - Warm Start (without ephemeris but with almanac time): 35s (average) / 40s (95% possibility)
 - Hot Start (with both ephemeris and almanac time): 2s (minimum) / 6s (95% possibility)
 - * Reference data with elevation angle of 5° or more and no interception environment with satellite powers $\geq -130\text{dBm}$. (Not in high sensitivity mode)

Note) "95% possibility" means "position time with 95% possibility".
- Positioning accuracy:
 - 2DRMS: approx. 5m
 - * Reference data with elevation angle of 5° or more and no interception environment with satellite powers $\geq -130\text{dBm}$.
- Measurement data update time: 1s
- Current consumption:
 - 40mW (average) while position calculating with tracking satellites in low power mode
 - 90mW (average) while position calculating with acquiring and tracking satellites
 - * Reference data using the Sony's reference board when the reference clock input is 18.414MHz, and its amplitude is 3.3V swing.
- 1PPS output
 - 1 μs or less precision, 1PPS outputs from ECLKOUT (Pin 97).

Note) These values are not guaranteed, depending on the conditions.

Block Diagram

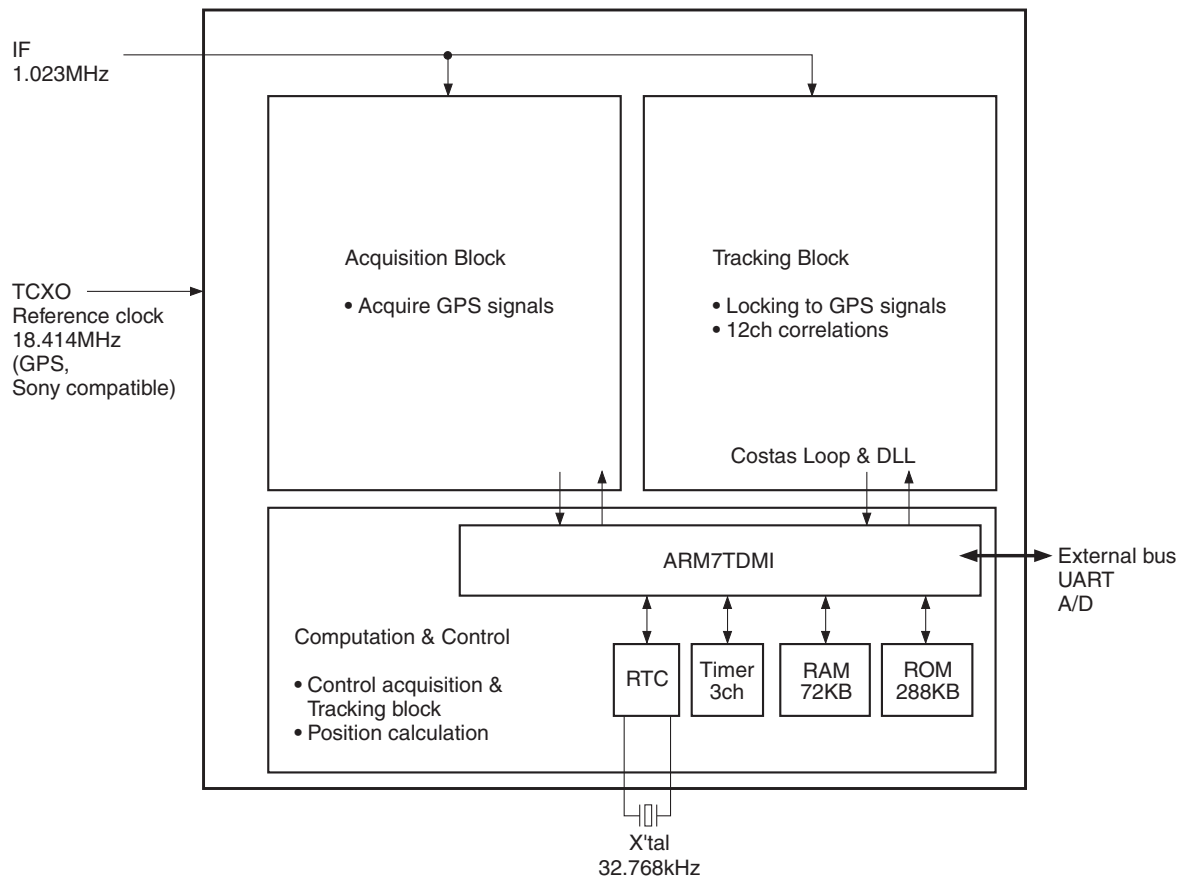

Pin Configuration (Top View)

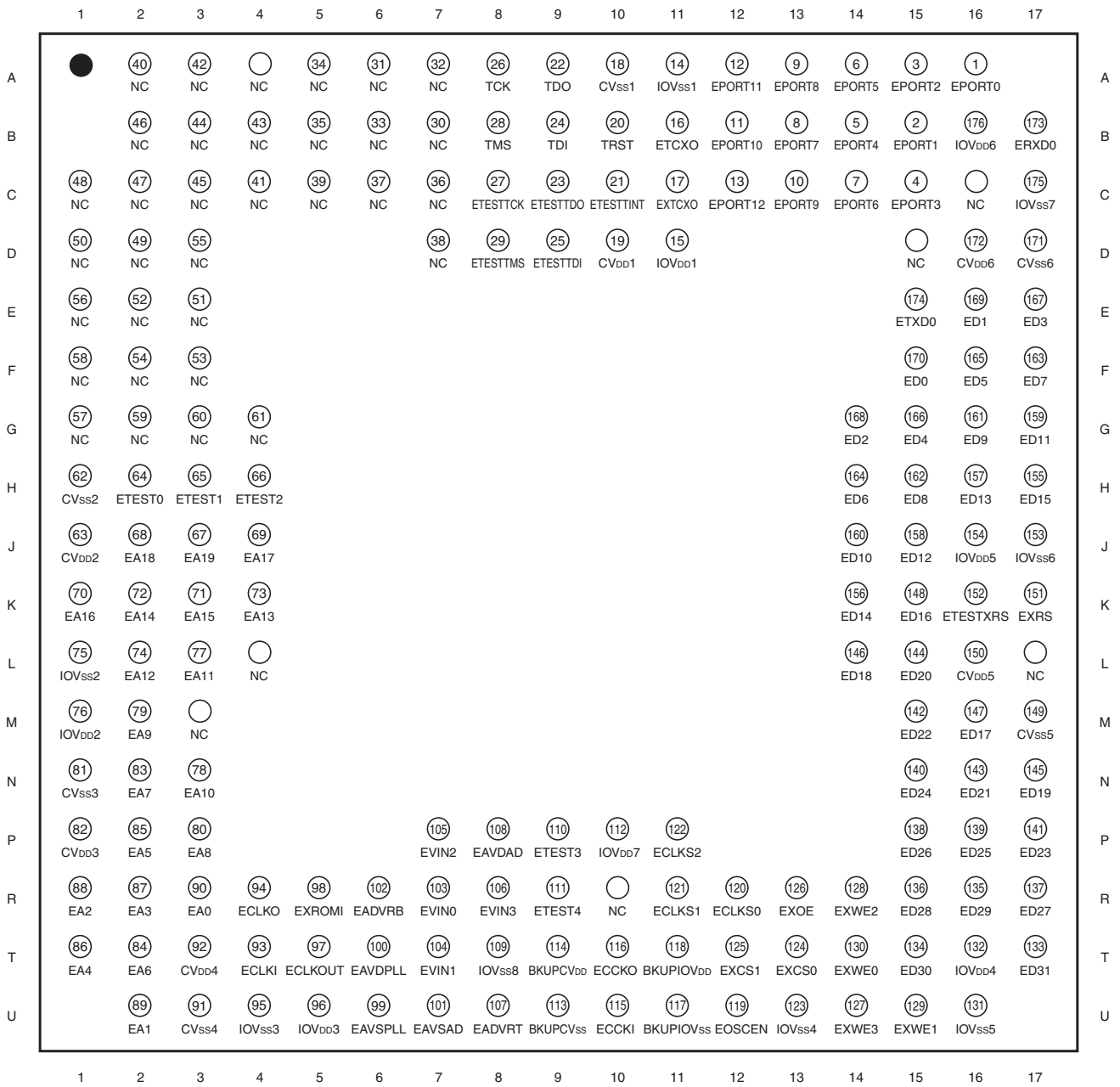

● : Pin 1 index.

Pin Description

Pin No.	Symbol	I/O	Description
1	EPORT0	I/O/Z	I/O port 0 (with a software controllable pull-down resistor, Pull-up.)
2	EPORT1	I/O/Z	I/O port 1 (with a software controllable pull-down resistor, See software application note.)
3	EPORT2	I/O/Z	I/O port 2 (with a software controllable pull-down resistor, See software application note.)
4	EPORT3	I/O/Z	I/O port 3 (with a software controllable pull-down resistor, See software application note.)
5	EPORT4	I/O/Z	I/O port 4 (with a software controllable pull-down resistor, IF signal input.)
6	EPORT5	I/O/Z	I/O port 5 (with a software controllable pull-down resistor, See software application note.)
7	EPORT6	I/O/Z	I/O port 6 (with a software controllable pull-down resistor, See software application note.)
8	EPORT7	I/O/Z	I/O port 7 (with a software controllable pull-down resistor, See software application note.)
9	EPORT8	I/O/Z	I/O port 8 (with a software controllable pull-down resistor, See software application note.)
10	EPORT9	I/O/Z	I/O port 9 (with a software controllable pull-down resistor, See software application note.)
11	EPORT10	I/O/Z	I/O port 10 (with a software controllable pull-down resistor, See software application note.)
12	EPORT11	I/O/Z	I/O port 11 (with a software controllable pull-down resistor, See software application note.)
13	EPORT12	I/O/Z	I/O port 12 (with a software controllable pull-down resistor, See software application note.)
14	IOV _{ss1}		GND
15	IOV _{DD1}		3.3V
16	ETCXO	I	TCXO oscillator (Frequency selectable, See software application note.)
17	EXTCXO	O	
18	CV _{ss1}		GND
19	CV _{DD1}		1.8V
20	TRST	I	Test (Open, with a pull-down resistor)
21	ETESTTINT	O	Test
22	TDO	O	Test
23	ETESTTDO	O	Test
24	TDI	I	Test (Open, with a pull-up resistor)
25	ETESTTDI	I	Test (Open, with a pull-up resistor)
26	TCK	I	Test (Open, with a pull-down resistor)
27	ETESTTCK	I	Test (Open, with a pull-down resistor)
28	TMS	I	Test (Open, with a pull-up resistor)

Pin No.	Symbol	I/O	Description
29	ETESTTMS	I	Test (Open, with a pull-up resistor)
30	NC		
31	NC		
32	NC		
33	NC		
34	NC		
35	NC		
36	NC		
37	NC		
38	NC		
39	NC		
40	NC		
41	NC		
42	NC		
43	NC		
44	NC		
45	NC		
46	NC		
47	NC		
48	NC		
49	NC		
50	NC		
51	NC		
52	NC		
53	NC		
54	NC		
55	NC		
56	NC		
57	NC		
58	NC		
59	NC		
60	NC		
61	NC		
62	CV _{ss2}		GND
63	CV _{DD2}		1.8V

Pin No.	Symbol	I/O	Description
64	ETEST0	I	Test (Connect to GND.)
65	ETSET1	I	
66	ETEST2	I	
67	EA19	O/Z	External expansion address 19
68	EA18	O/Z	External expansion address 18
69	EA17	O/Z	External expansion address 17
70	EA16	O/Z	External expansion address 16
71	EA15	O/Z	External expansion address 15
72	EA14	O/Z	External expansion address 14
73	EA13	O/Z	External expansion address 13
74	EA12	O/Z	External expansion address 12
75	IOV _{SS2}		GND
76	IOV _{DD2}		3.3V
77	EA11	O/Z	External expansion address 11
78	EA10	O/Z	External expansion address 10
79	EA9	O/Z	External expansion address 9
80	EA8	O/Z	External expansion address 8
81	CV _{SS3}		GND
82	CV _{DD3}		1.8V
83	EA7	O/Z	External expansion address 7
84	EA6	O/Z	External expansion address 6
85	EA5	O/Z	External expansion address 5
86	EA4	O/Z	External expansion address 4
87	EA3	O/Z	External expansion address 3
88	EA2	O/Z	External expansion address 2
89	EA1	O/Z	External expansion address 1
90	EA0	O/Z	External expansion address 0
91	CV _{SS4}		GND
92	CV _{DD4}		1.8V
93	ECLKI	I	CPU clock oscillator
94	ECLKO	O	
95	IOV _{SS3}		GND
96	IOV _{DD3}		3.3V
97	ECLKOUT	O/Z	1PPS output (Effective 1s late after reset release)
98	EXROMI	I	Boot selection (Low: Internal ROM, High: External Memory/EXCS0)
99	EAVSPLL		PLL GND
100	EAVDPLL		PLL 3.3V

Pin No.	Symbol	I/O	Description
101	EAVSAD		A/D converter GND
102	EADVRB	I	A/D converter Reference input Bottom
103	EVIN0	I	A/D converter Analog input 0
104	EVIN1	I	A/D converter Analog input 1
105	EVIN2	I	A/D converter Analog input 2
106	EVIN3	I	A/D converter Analog input 3
107	EADVRT	I	A/D converter Reference input Top
108	EAVDAD		A/D converter 3.3V
109	IOV _{ss8}		GND
110	ETEST3	I/O/Z	Test (Connect to GND with a resistor.)
111	ETEST4	I/O/Z	Test (Connect to GND with a resistor.)
112	IOV _{DD7}		3.3V
113	BKUPCV _{ss}		Backup core power supply GND
114	BKUPCV _{DD}		Backup core power supply 1.8V
115	ECCKI	I	RTC oscillator (32.768kHz, includes feedback resistor.)
116	ECCKO	O	
117	BKUPIOV _{ss}		Backup I/O power supply GND
118	BKUPIOV _{DD}		Backup I/O power supply 3.3V
119	EOSCEN	I	Oscillator enable (H-Active), See backup mode section.
120	ECLKS0	I	Test (Connect to GND.)
121	ECLKS1	I	Test (Connect to GND.)
122	ECLKS2	I	Test (Connect to GND.)
123	IOV _{ss4}		GND
124	EXCS0	O/Z	External expansion chip selection 0 (Program boot is enable if EXROMI is high.)
125	EXCS1	O/Z	External expansion chip selection 1
126	EXOE	O/Z	External expansion read signal
127	EXWE3	O/Z	External expansion write signal
128	EXWE2	O/Z	External expansion write signal
129	EXWE1	O/Z	External expansion write signal
130	EXWE0	O/Z	External expansion write signal
131	IOV _{ss5}		GND
132	IOV _{DD4}		3.3V
133	ED31	I/O	External expansion data 31 (with a pull-down resistor)
134	ED30	I/O	External expansion data 30 (with a pull-down resistor)
135	ED29	I/O	External expansion data 29 (with a pull-down resistor)
136	ED28	I/O	External expansion data 28 (with a pull-down resistor)
137	ED27	I/O	External expansion data 27 (with a pull-down resistor)
138	ED26	I/O	External expansion data 26 (with a pull-down resistor)

Pin No.	Symbol	I/O	Description
139	ED25	I/O	External expansion data 25 (with a pull-down resistor)
140	ED24	I/O	External expansion data 24 (with a pull-down resistor)
141	ED23	I/O	External expansion data 23 (with a pull-down resistor)
142	ED22	I/O	External expansion data 22 (with a pull-down resistor)
143	ED21	I/O	External expansion data 21 (with a pull-down resistor)
144	ED20	I/O	External expansion data 20 (with a pull-down resistor)
145	ED19	I/O	External expansion data 19 (with a pull-down resistor)
146	ED18	I/O	External expansion data 18 (with a pull-down resistor)
147	ED17	I/O	External expansion data 17 (with a pull-down resistor)
148	ED16	I/O	External expansion data 16 (with a pull-down resistor)
149	CV _{ss5}		GND
150	CV _{DD5}		1.8V
151	EXRS	I	Reset (L-Active)
152	E _{TESTXRS}	I	Test (Open, with a pull-up resistor)
153	IOV _{ss6}		GND
154	IOV _{DD5}		3.3V
155	ED15	I/O	External expansion data 15 (with a pull-down resistor)
156	ED14	I/O	External expansion data 14 (with a pull-down resistor)
157	ED13	I/O	External expansion data 13 (with a pull-down resistor)
158	ED12	I/O	External expansion data 12 (with a pull-down resistor)
159	ED11	I/O	External expansion data 11 (with a pull-down resistor)
160	ED10	I/O	External expansion data 10 (with a pull-down resistor)
161	ED9	I/O	External expansion data 9 (with a pull-down resistor)
162	ED8	I/O	External expansion data 8 (with a pull-down resistor)
163	ED7	I/O	External expansion data 7 (with a pull-down resistor)
164	ED6	I/O	External expansion data 6 (with a pull-down resistor)
165	ED5	I/O	External expansion data 5 (with a pull-down resistor)
166	ED4	I/O	External expansion data 4 (with a pull-down resistor)
167	ED3	I/O	External expansion data 3 (with a pull-down resistor)
168	ED2	I/O	External expansion data 2 (with a pull-down resistor)
169	ED1	I/O	External expansion data 1 (with a pull-down resistor)
170	ED0	I/O	External expansion data 0 (with a pull-down resistor)
171	CV _{ss6}		GND
172	CV _{DD6}		1.8V
173	ERXD0	I	UART (CH0) reception data (with a pull-down resistor during reset interval)
174	ETXD0	O/Z	UART (CH0) transmission data (with Hi-Z during reset interval)
175	IOV _{ss7}		GND
176	IOV _{DD6}		3.3V

A/D Converter Operating Conditions

Item	Symbol	Pin name	Min.	Typ.	Max.	Unit
Supply voltage	V _{AD}	EAVDAD*1	3.0	3.3	3.6	V
Operating temperature	T _a	—	−40.0		+85.0	°C

A/D Converter Characteristics(V_{AD} = 3.0 to 3.6V, T_a = −40 to +85°C)

Item	Symbol	Conditions	Min.	Typ.	Max.	Unit
Resolution					10	Bit
Channel					4	Ch
Differential linearity error (DLE)		V _{AD} = 3.0V, V _{RT} = 3.0V, V _{RB} = 0.3V	−1.0		+1.0	LSB
Integral linearity error (ILE)			−2.0		+2.0	LSB
Sampling time		TCXO = 18.414MHz	3			μs
Conversion time					11	μs
Reference input voltage (Top)	V _{RT} *2		2.0		V _{AD}	V
Reference input voltage (Bottom)	V _{RB} *3		0		0.7	V
Analog input voltage	V _{IN} *4		V _{RB}		V _{RT}	V
Current consumption		V _{AD} = 3.0V		1.6		mA

Applicable pins

*1 EAVDAD (Pin 108)

*2 EADVRT (Pin 107)

*3 EADVRB (Pin 102)

*4 EVIN[0:3] (Pins 103 to 106)

DC Characteristics

(IOV_{DD} = 3.0 to 3.6V, CV_{DD} = 1.62 to 1.98V, Ta = -40 to +85°C)

Item	Symbol	Conditions	Min.	Typ.	Max.	Unit
Input voltage*1	High level	V _{IH}	0.7IOV _{DD}		5.5	V
	Low level	V _{IL}			0.2IOV _{DD}	V
Output voltage*2	High level	V _{OH1}	I _{OH} = 4mA	2.4		V
	Low level	V _{OL1}	I _{OL} = 4mA		0.4	V
Output voltage*3	High level	V _{OH2}	I _{OH} = 8mA	2.4		V
	Low level	V _{OL2}	I _{OL} = 8mA		0.4	V
Pull-up resistor*4	R _U		56		110	kΩ
Pull-down resistor*5	R _D		51		100	kΩ
Current consumption during normal operation (via IOV _{DD} and CV _{DD})*6	I _{OPE}	TCXO = 18.414MHz, Ta = 25°C		45		mA
Current consumption during backup operation (via BKUPIOV _{DD})*7	I _{STB1}	BKUPIOV _{DD} = 3.6V, Ta = 25°C		0.2	1.0	μA
		BKUPIOV _{DD} = 3.6V, Ta = 85°C		0.2	1.0	μA
Current consumption during backup operation (via BKUPCV _{DD})*8	I _{STB2}	BKUPCV _{DD} = 1.98V, Ta = 25°C		7.5	15	μA
		BKUPCV _{DD} = 1.98V, Ta = 85°C		50	120	μA

Applicable pins

*1 Pins 1 to 13, 20, 24 to 29, 64 to 66, 98, 119, 120 to 122, 133 to 148, 151, 152, 155 to 170, 173

*2 Pins 1 to 13, 21 to 23, 97, 174

*3 Pins 67 to 74, 77 to 80, 83 to 90, 124 to 130, 133 to 148, 155 to 170

*4 Pins 24, 25, 28, 29, 152

*5 Pins 1 to 13, 20, 26, 27, 133 to 148, 155 to 170, 173

*6 Pins 15, 76, 96, 132, 154, 176 (3.3V)

Pins 19, 63, 82, 92, 150, 172 (1.8V)

*7 Pin 118

*8 Pin 114

AC Characteristics

• External RAM I/F (Read/32-bit mode)

($C_{VDD} = 1.62$ to $1.98V$, $IOV_{DD} = 3.0$ to $3.6V$, $C_L = 25pF$, $T_{opr} = -40$ to $+85^{\circ}C$)

Item	Symbol	Min.	Max.	Unit
EXOE ↓ to address valid	Toea		3	ns
EXOE ↓ to EXCS ↓	Toecs		1	ns
Data setup	Tas		15	ns
Data hold	Tah		0	ns

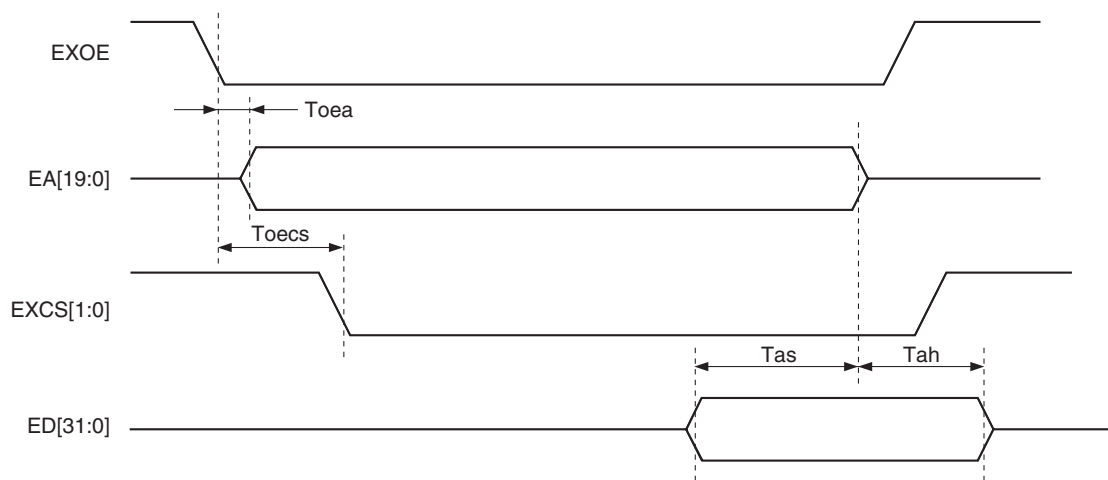

• External RAM I/F (Write/32-bit mode (1-wait))

(CV_{DD} = 1.62 to 1.98V, IOV_{DD} = 3.0 to 3.6V, C_L = 25pF, Topr = -40 to +85°C)

Item	Symbol	Min.	Max.	Unit
EXCS ↓ to address valid	Tcsfav		2	ns
EXCS ↓ to EXWE ↓	Tcswef		T _{sys} - 1	ns
EXCS ↓ to EXWE ↑	Tcswer		T _{sys} × 3 - 2	ns
EXCS ↓ to data valid	Tcsd		15	ns

* T_{sys}: ARM clock cycle

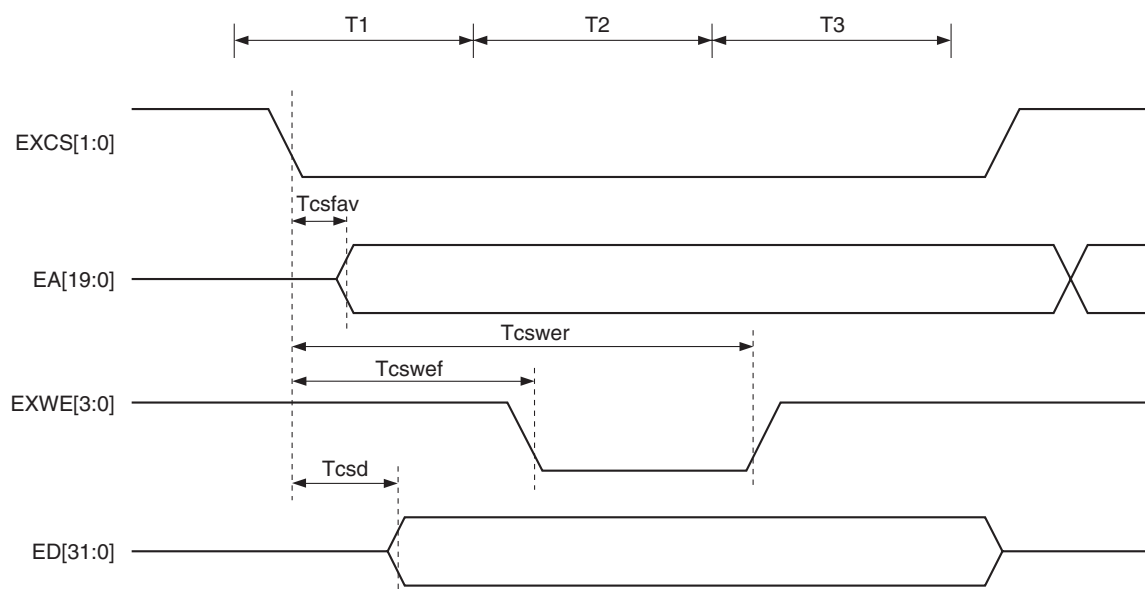

Backup Mode

The backup mode is established by setting both EOSCEN and EXRS low. In this mode, the low power consumption can be achieved by stopping all oscillators except for RTC oscillator during the reset interval. Although all registers are initialized, the SRAM contents in backup area are held.

In order to cancel this mode (reset cancellation), please set EOSCEN high at first and then set EXRS high after the oscillation stabilization time and PLL lock time have passed. It needs 100ms or more.

See Initialization section.

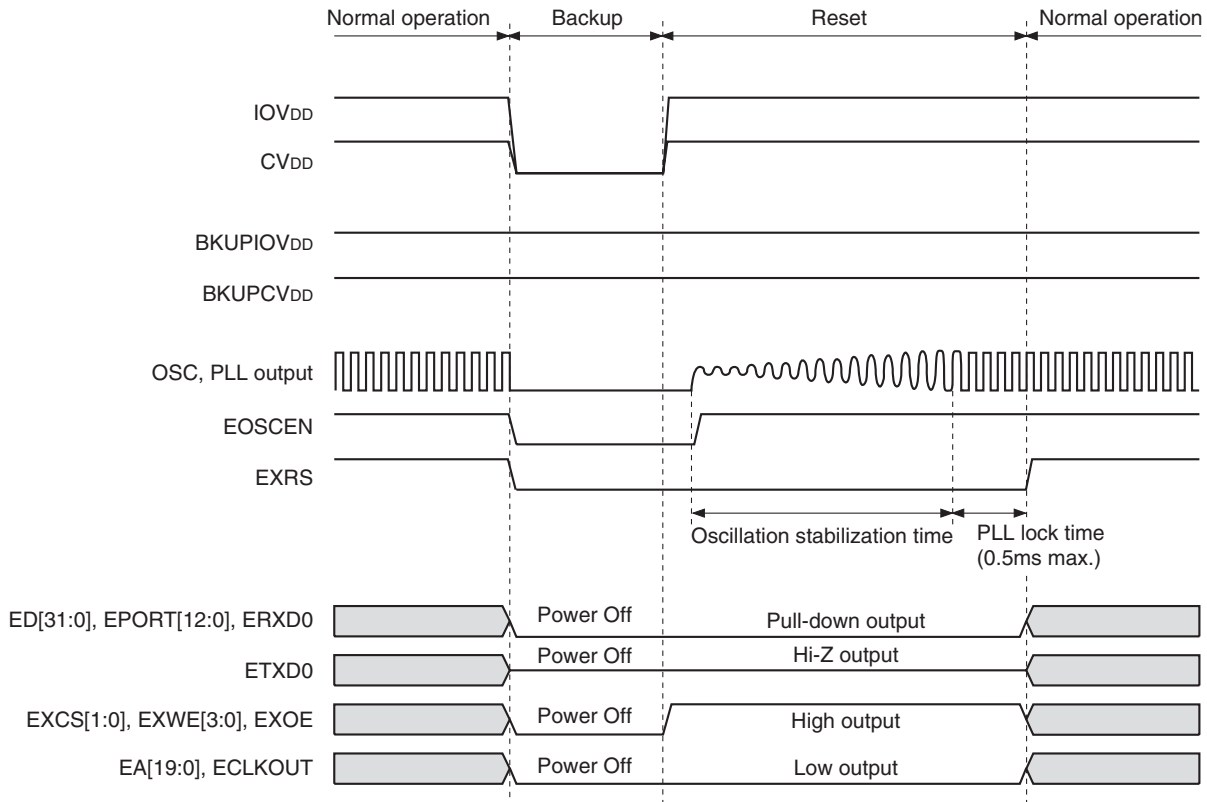

Initialization

The CXD2956AGL-1 is initialized by setting the reset signal EXRS (Pin 151) to the low level. Note that internal RAM is not initialized by the operation. Satisfy the conditions shown below for the timing and others.

1. When turning the power on (Power-on reset)

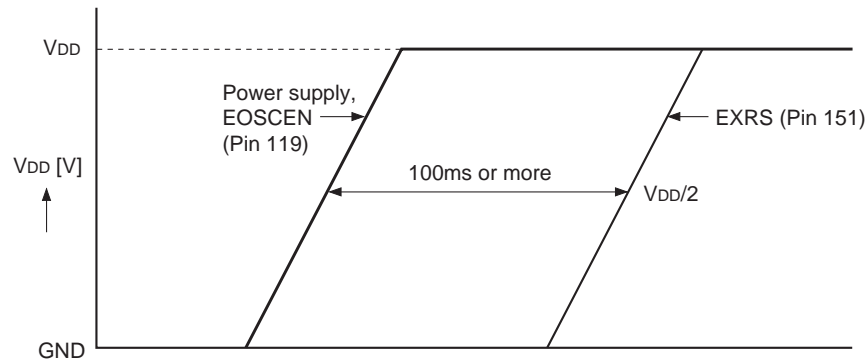

Since there is a possibility that overcurrent may flow, please be sure to add power supply to the LSI before activate functional pin of this LSI. Additionally, the power supply both 3.3V and 1.8V should turn on simultaneously, and EOSCEN (Pin 119) should also rise simultaneously with the power supply turning on. EXRS (Pin 151) should rise 100ms or more after the power supply and EOSCEN rise.

2. Initialization during operation

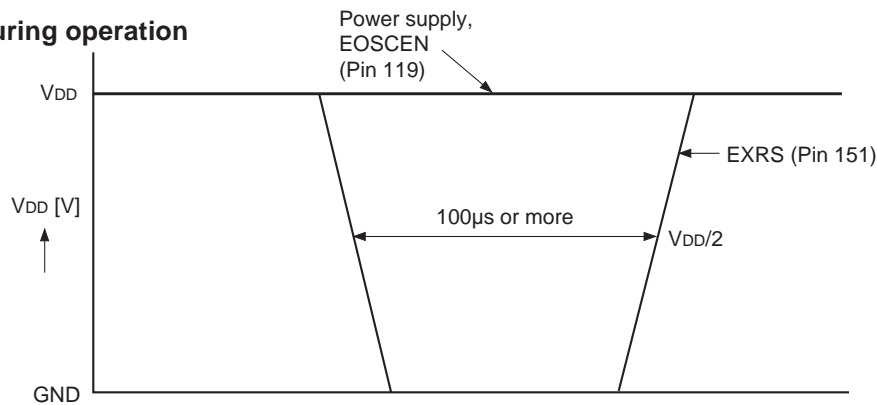

For initialization during operation, the interior circuit except internal RAM is initialized by setting the EXRS (Pin 151) signal to the low level for 100µs or more. Note that internal RAM is not also initialized by the operation. At this time, the EOSCEN (Pin 119) signal should keep the high level.

RTC Crystal and TCXO

In order to operate CXD2956AGL-1 appropriately, the recommended characteristics of RTC crystal and TCXO is shown below.

Recommended characteristics of RTC crystal

Operating temperature	-40 to +85°C
Nominal frequency	32.768kHz
Frequency tolerance	±20ppm
Frequency temperature coefficient	-0.04ppm/°C ² (Max.)
Frequency peak temperature	+25 ± 5°C
Frequency aging	±3ppm/year

Recommended characteristics of TCXO

Operating temperature	-40 to +85°C
Frequency tolerance	±2.0ppm
Frequency vs. temperature	±2.5ppm
Frequency vs. supply voltage	±0.2ppm
Frequency vs. load	±0.2ppm
Frequency aging	±1ppm/year

Recommended parts

RTC crystal	EPSON FC-255
TCXO	NDK SNA3088B (NT5032 Series)

Application Circuit

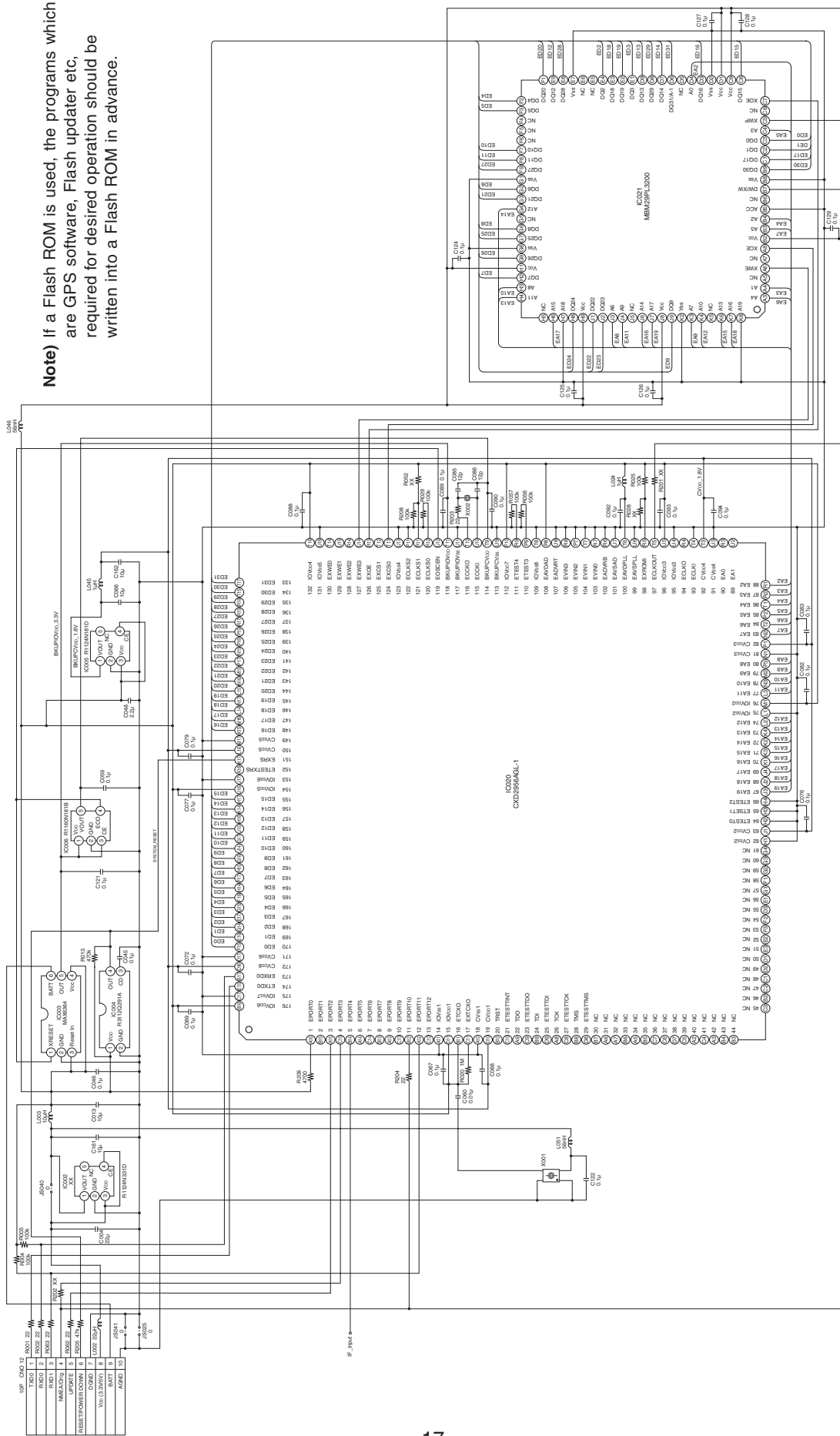

Package Outline Unit: mm

183PIN VFLGA (PLASTIC)

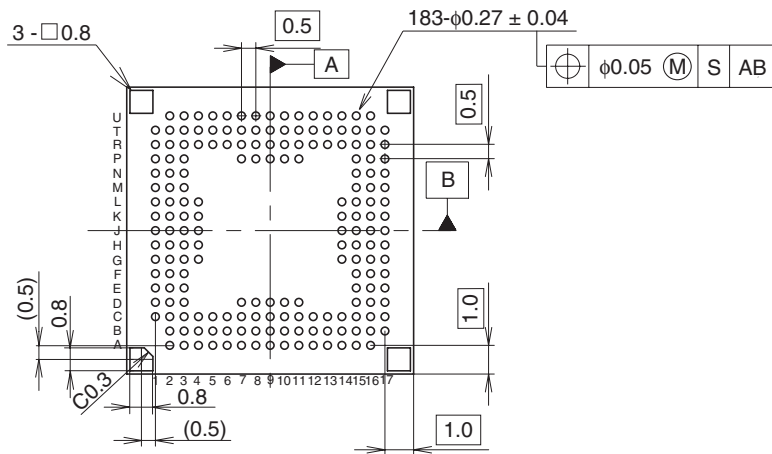
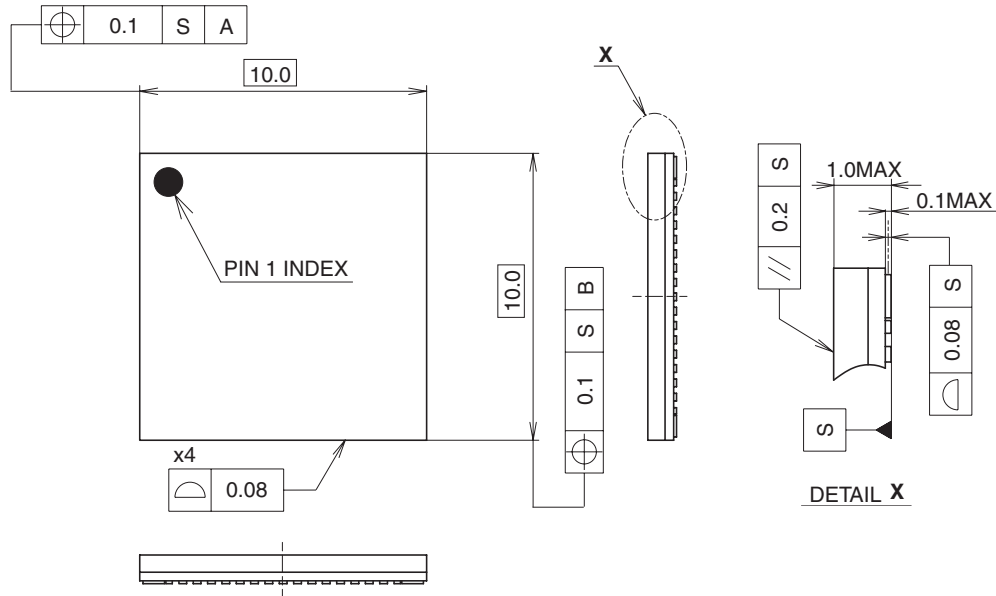

SONY CODE	VFLGA-183P-051
EIAJ CODE	P-VFLGA183-10X10-0.5
JEDEC CODE	—

PACKAGE MATERIAL	ORGANIC SUBSTRATE
TERMINAL TREATMENT	NICKEL & GOLD PLATING
TERMINAL MATERIAL	COPPER
PACKAGE MASS	0.3g