

# HPI - 6FFR4

The HPI - 6FFR4 is a high - output, high - speed silicon PIN photodiode mounted in a sidelooking package. The photodiode is small size, low profile and easy mounting.

**FEATURES**

- High - output power
- High - speed response
- Wide angular response
- Low - cost
- Sidelooking plastic package

**APPLICATIONS**

- Remote control sensors
- Optical switches
- Photocoupler

**DIMENSIONS**

(Unit : mm)

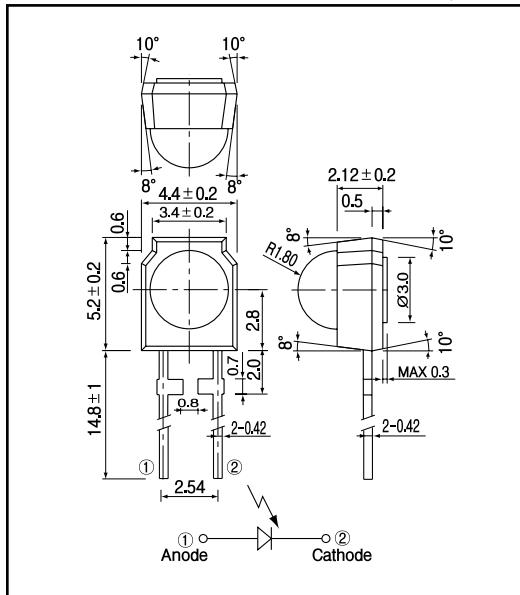

**MAXIMUM RATINGS**

(Ta=25 )

Item	Symbol	Rating	Unit
Reverse voltage	$V_R$	35	V
Operating temp.	$T_{opr.}$	- 30 +70	
Storage temp.	$T_{stg.}$	- 40 +80	
Soldering temp.*1	$T_{sol.}$	260	

\*1.For MAX.5 seconds at the position of 2 mm from the package

**ELECTRO-OPTICAL CHARACTERISTICS**

(Ta=25 )

Item	Symbol	Conditions	Min.	Typ.	Max.	Unit.
Open circuit voltage	$V_{oc}$	$E_v = 1,000lx^2$		0.38		V
Short circuit current	$I_{sc}$			20		$\mu A$
Curve factor	C.F.	$V_R = 10V$			10	nA
Dark current	$I_d$		0.55			-
Capacitance	$C_t$	$V = 0V, f = 1MHz$		16		pF
Temperature coefficient of $V_{oc}$	t			- 2.2		mV/
Temperature coefficient of $I_{sc}$	t			0.18		%/
Spectral sensitivity				880 1050		nm
Peak wavelength	$\lambda_p$			1,000		nm
Half angle				$\pm 35$		deg

\*2.Color temp.=2856K standard Tungsten lamp

**PIN Photodiode**

**HPI - 6FFR4**

**Light current Vs. Forward voltage**

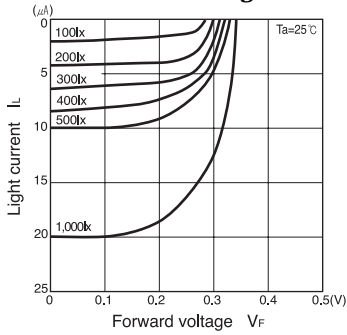

**Short circuit current I\_sc Vs. Illuminance**

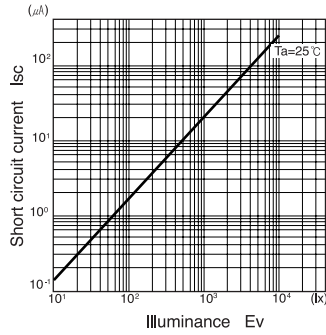

**Dark current I\_d Vs. Ambient temperature T\_a**

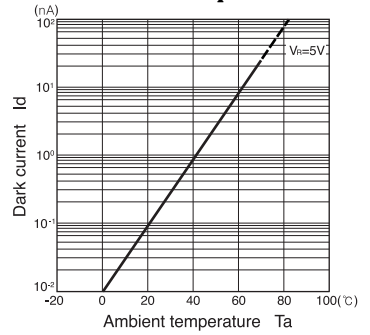

**Relative sensitivity Vs. Wavelength**

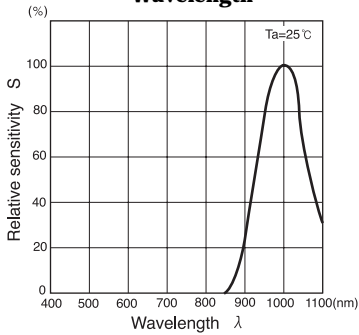

**Dark current I\_d Vs. Reverse voltage V\_R**

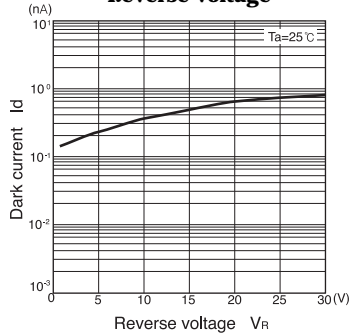

**Radiant Pattern**

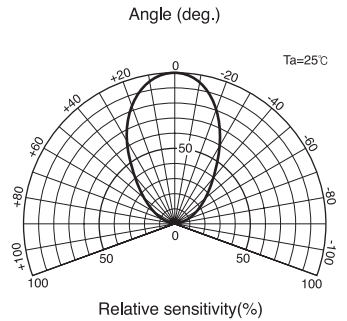

**Capacitance between terminals C\_t Vs. Reverse voltage V\_R**

