

SWITCHING APPLICATION.
INTERFACE CIRCUIT AND DRIVER CIRCUIT APPLICATION.

FEATURES

- With Built-in Bias Resistors.
- Simplify Circuit Design.
- Reduce a Quantity of Parts and Manufacturing Process.
- High Packing Density.

EQUIVALENT CIRCUIT

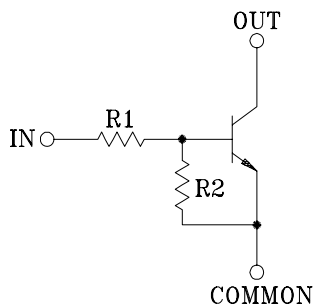

BIAS RESISTOR VALUES

TYPE NO.	R1(kΩ)	R2(kΩ)
KRC401	4.7	4.7
KRC402	10	10
KRC403	22	22
KRC404	47	47
KRC405	2.2	47
KRC406	4.7	47

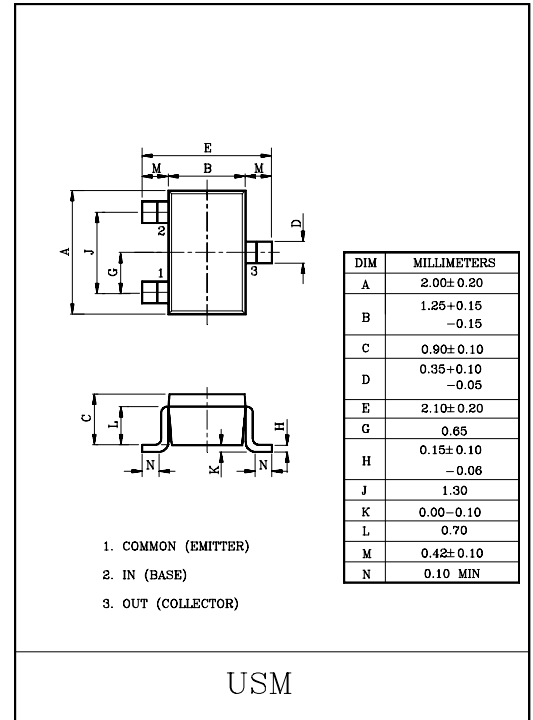

MAXIMUM RATINGS (Ta=25°C)

CHARACTERISTIC		SYMBOL	RATING	UNIT
Output Voltage	KRC401 ~406	V _O	50	V
Input Voltage	KRC401	V _I	20, -10	V
	KRC402		30, -10	
	KRC403		40, -10	
	KRC404		40, -10	
	KRC405		12, -5	
	KRC406		20, -5	
Output Current	KRC401 ~406	I _O	100	mA
Power Dissipation		P _D	100	mW
Junction Temperature		T _j	150	°C
Storage Temperature Range		T _{stg}	-55~150	°C

MARK SPEC

TYPE	KRC401	KRC402	KRC403	KRC404	KRC405	KRC406
MARK	NA	NB	NC	ND	NE	NF

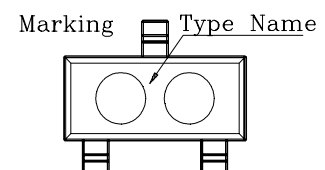

KRC401 ~ KRC406

ELECTRICAL CHARACTERISTICS (Ta=25°C)

CHARACTERISTIC		SYMBOL	TEST CONDITION	MIN.	TYP.	MAX.	UNIT
Output Cut-off Current	KRC401 ~ 406	$I_{O(OFF)}$	$V_0=50V, V_1=0$	-	-	500	nA
DC Current Gain	KRC401	G_I	$V_0=5V, I_0=10mA$	30	55	-	
	KRC402			50	80	-	
	KRC403			70	120	-	
	KRC404			80	200	-	
	KRC405			80	200	-	
	KRC406			80	200	-	
Output Voltage	KRC401 ~ 406	$V_{O(ON)}$	$I_0=10mA, I_1=0.5mA$	-	0.1	0.3	V
Input Voltage (ON)	KRC401	$V_{I(ON)}$	$V_0=0.2V, I_0=5mA$	-	1.5	2.0	V
	KRC402			-	1.8	2.4	
	KRC403			-	2.1	3.0	
	KRC404			-	2.8	5.0	
	KRC405			-	0.8	1.1	
	KRC406			-	0.9	1.3	
Input Voltage (OFF)	KRC401 ~ 404	$V_{I(OFF)}$	$V_0=5V, I_0=0.1mA$	1.0	1.2	-	V
	KRC405 ~ 406			0.5	0.65	-	
Transition Frequency	KRC401 ~ 406	$f_T *$	$V_0=10V, I_0=5mA$	-	200	-	MHz
Input Current	KRC401	I_I	$V_1=5V$	-	-	1.8	mA
	KRC402			-	-	0.88	
	KRC403			-	-	0.36	
	KRC404			-	-	0.18	
	KRC405			-	-	3.6	
	KRC406			-	-	1.8	

Note : *Characteristic of Transistor Only

KRC401 ~ KRC406

ELECTRICAL CHARACTERISTICS (Ta=25°C)

CHARACTERISTIC		SYMBOL	TEST CONDITION	MIN.	TYP.	MAX.	UNIT
Switching Time	Rise Time	KRC401	V _O =5V V _{IN} =5V R _L =1kΩ	-	0.03	-	μS
		KRC402		-	0.05	-	
		KRC403		-	0.12	-	
		KRC404		-	0.22	-	
		KRC405		-	0.01	-	
		KRC406		-	0.03	-	
	Storage Time	KRC401		-	2.0	-	
		KRC402		-	2.0	-	
		KRC403		-	2.0	-	
		KRC404		-	2.0	-	
		KRC405		-	2.0	-	
		KRC406		-	2.0	-	
	Fall Time	KRC401		-	0.12	-	
		KRC402		-	0.36	-	
		KRC403		-	0.35	-	
		KRC404		-	0.6	-	
		KRC405		-	0.1	-	
		KRC406		-	0.19	-	

KRC401 ~ KRC406

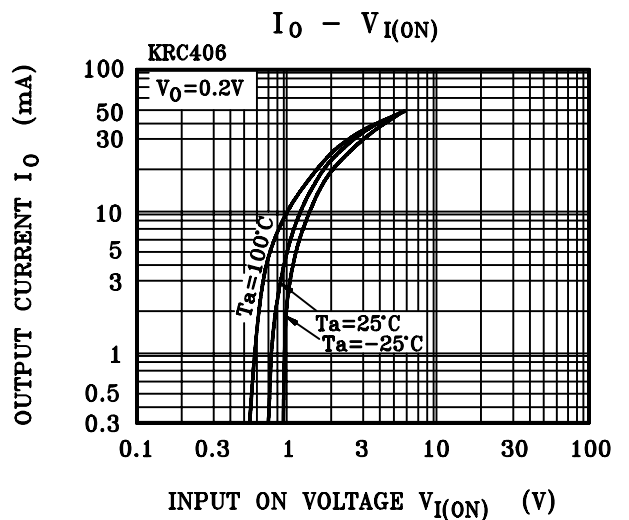
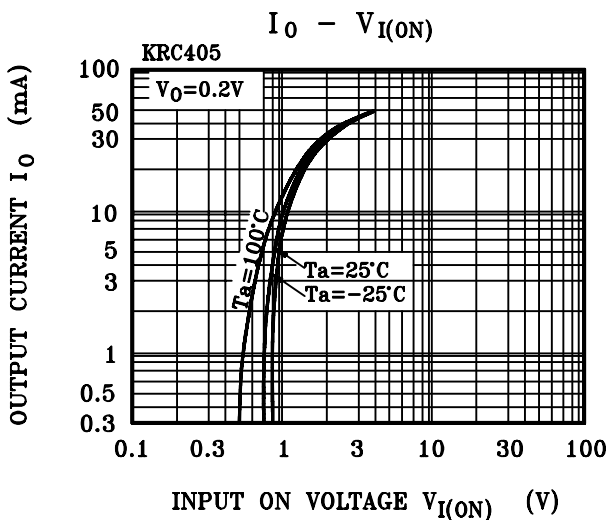
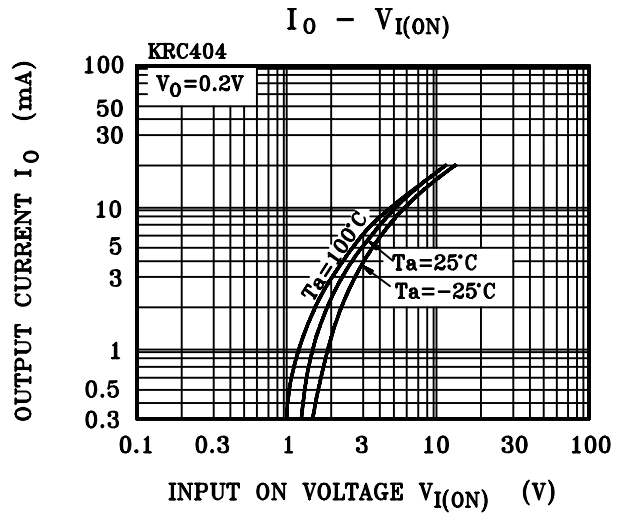
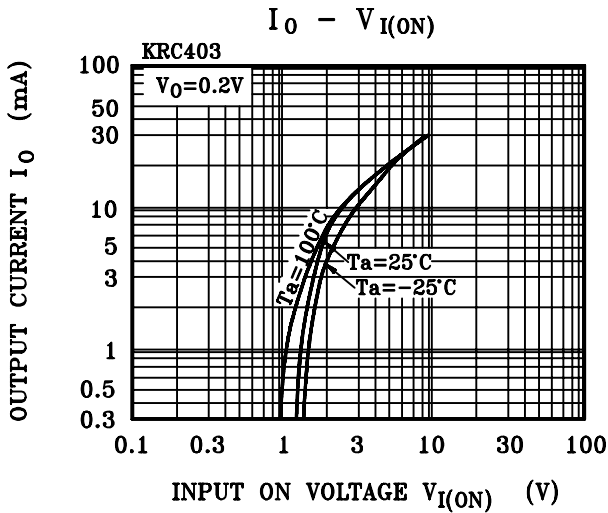
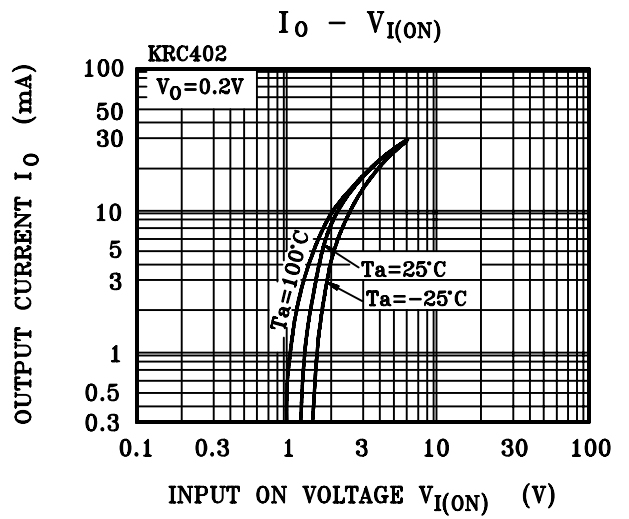
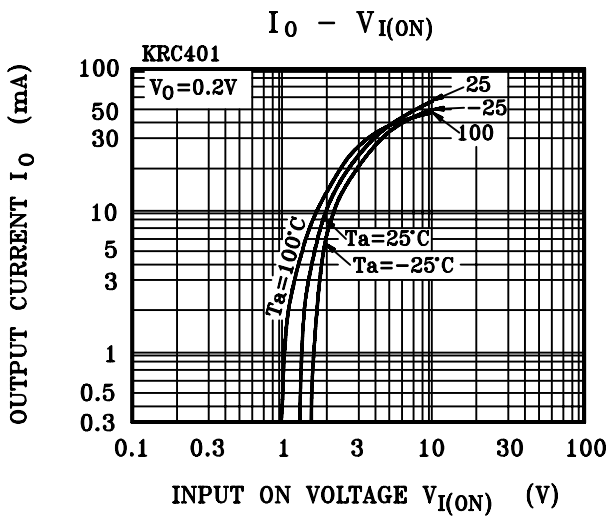

KRC401 ~ KRC406

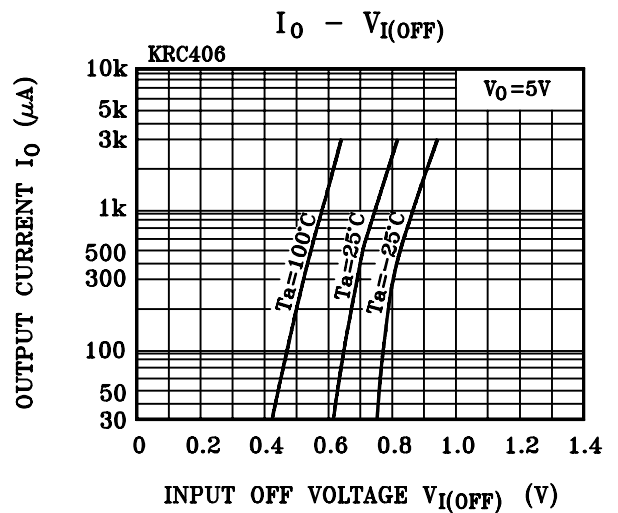
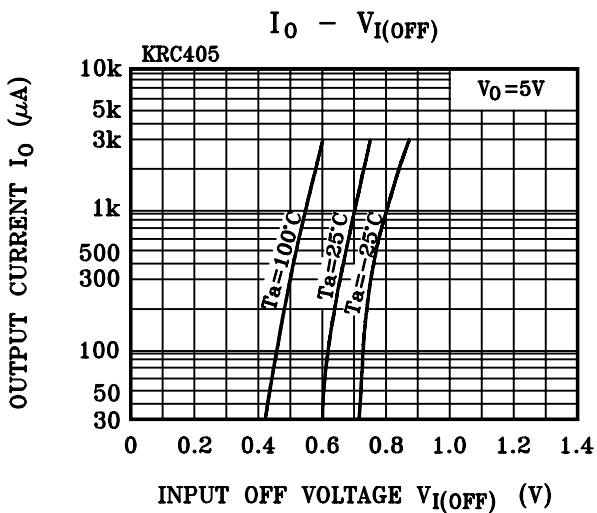
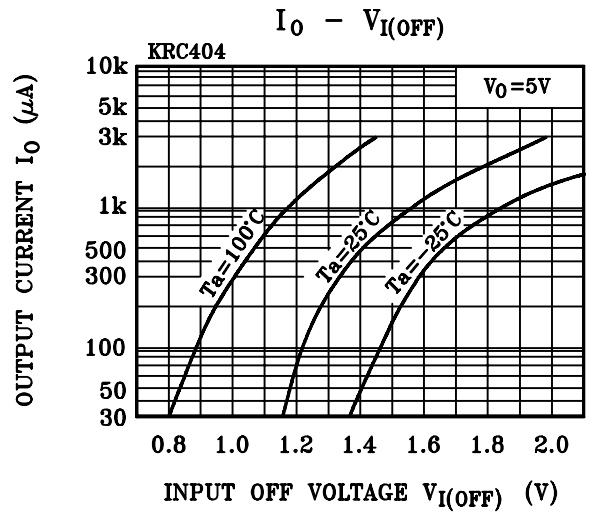
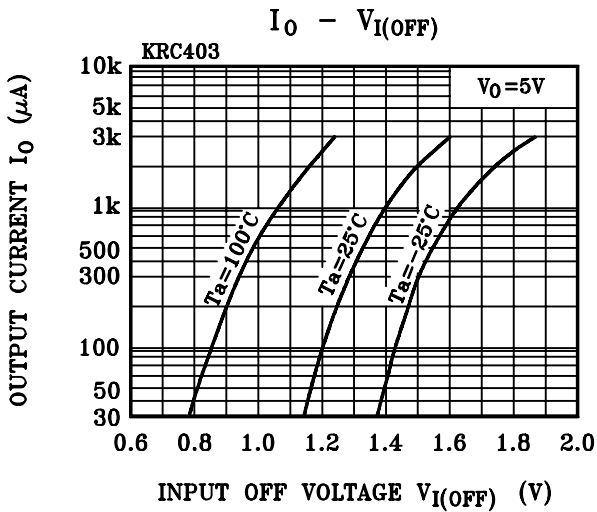
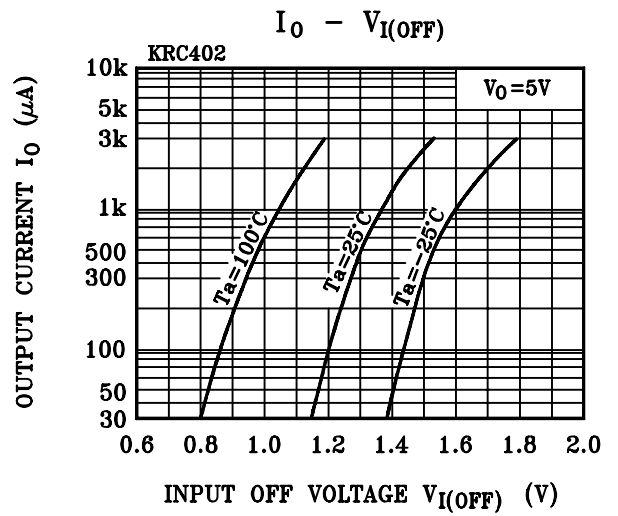
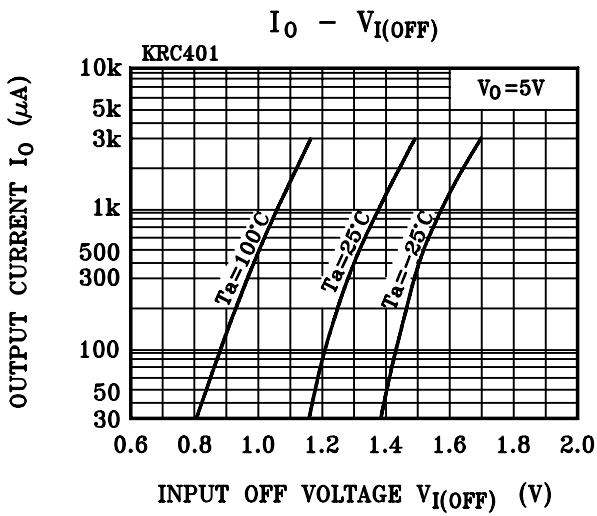

KRC401 ~ KRC406

