



Multiformat 216 MHz Video Encoder with Six NSV™ 12-Bit DACs

ADV7310/ADV7311

FEATURES

High Definition Input Formats

8-/10-, 16-/20-, 24-/30-Bit (4:2:2, 4:4:4) Parallel YCrCb

Compliant with:

SMPTE 293M (525p)

BTA T-1004 EDTV2 (525p)

ITU-R BT.1358 (625p/525p)

ITU-R BT.1362 (625p/525p)

SMPTE 274M (1080i) at 30 Hz and 25 Hz

SMPTE 296M (720p)

RGB in 3×10-Bit 4:4:4 Input Format

HDTV RGB Supported:

RGB, RGBHV

Other High Definition Formats Using Async
Timing Mode

High Definition Output Formats

YPrPb Progressive Scan (EIA-770.1, EIA-770.2)

YPrPb HDTV (EIA 770.3)

RGB, RGBHV

CGMS-A (720p/1080i)

Macrovision Rev 1.1 (525p/625p)*

CGMS-A (525p)

Standard Definition Input Formats

CCIR-656 4:2:2 8-/10-/16-/20-Bit Parallel Input

Standard Definition Output Formats

Composite NTSC M/N

Composite PAL M/N/B/D/G/H/I, PAL-60

SMPTE 170M NTSC Compatible Composite Video

ITU-R BT.470 PAL Compatible Composite Video

S-Video (Y/C)

EuroScart RGB

Component YPrPb (Betacam, MII, SMPTE/EBU N10)

Macrovision Rev 7.1.L1*

CGMS/WSS

Closed Captioning

GENERAL FEATURES

Simultaneous SD and HD Inputs and Outputs

Oversampling up to 216 MHz

Programmable DAC Gain Control

Sync Outputs in All Modes

On-Board Voltage Reference

Six 12-Bit NSV Precision Video DACs

2-Wire Serial I²C® Interface

Dual I/O Supply 2.5 V/3.3 V Operation

Analog and Digital Supply 2.5 V

On-Board PLL

64-Lead LQFP Package

Lead (Pb) Free Product

APPLICATIONS

High End DVD

High End PS DVD Recorders/Players

SD/Prog Scan/HDTV Display Devices

SD/HDTV Set Top Boxes

Professional Video Systems

SIMPLIFIED FUNCTIONAL BLOCK DIAGRAM

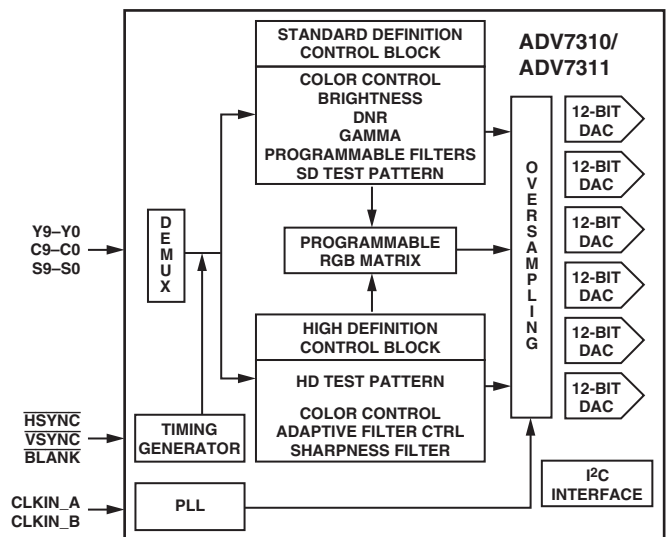

GENERAL DESCRIPTION

The ADV[®]7310/ADV7311 is a high speed, digital-to-analog encoder on a single monolithic chip. It includes six high speed NSV video D/A converters with TTL compatible inputs.

The ADV7310/ADV7311 has separate 8-/10-/16-/20-bit input ports that accept data in high definition and/or standard definition video format. For all standards, external horizontal, vertical, and blanking signals or EAV/SAV timing codes control the insertion of appropriate synchronization signals into the digital data stream and therefore the output signal.

Purchase of licensed I²C components of Analog Devices or one of its sublicensed Associated Companies conveys a license for the purchaser under the Philips I²C Patent Rights to use these components in an I²C system, provided that the system conforms to the I²C Standard Specification as defined by Philips.

*ADV7310 Only

REV. A

Information furnished by Analog Devices is believed to be accurate and reliable. However, no responsibility is assumed by Analog Devices for its use, nor for any infringements of patents or other rights of third parties that may result from its use. No license is granted by implication or otherwise under any patent or patent rights of Analog Devices. Trademarks and registered trademarks are the property of their respective owners.

One Technology Way, P.O. Box 9106, Norwood, MA 02062-9106, U.S.A.
Tel: 781/329-4700 www.analog.com
Fax: 781/326-8703 © 2003 Analog Devices, Inc. All rights reserved.

ADV7310/ADV7311

DETAILED FEATURES

High Definition Programmable Features (720p/1080i)

- 2× Oversampling (148.5 MHz)
- Internal Test Pattern Generator
(Color Hatch, Black Bar, Flat Field/Frame)
- Fully Programmable YCrCb to RGB Matrix
- Gamma Correction
- Programmable Adaptive Filter Control
- Programmable Sharpness Filter Control
- CGMS-A (720p/1080i)

High Definition Programmable Features (525p/625p)

- 8× Oversampling (216 MHz Output)
- Internal Test Pattern Generator
(Color Hatch, Black Bar, Flat Frame)
- Individual Y and PrPb Output Delay
- Gamma Correction
- Programmable Adaptive Filter Control
- Fully Programmable YCrCb to RGB Matrix
- Undershoot Limiter

- Macrovision Rev 1.1 (525p/625p)*
- CGMS-A (525p)

Standard Definition Programmable Features

- 16× Oversampling (216 MHz)
- Internal Test Pattern Generator (Color Bars, Black Bar)

Controlled Edge Rates for Sync, Active Video

Individual Y and PrPb Output Delay

Gamma Correction

Digital Noise Reduction (DNR)

Multiple Chroma and Luma Filters

Luma-SSAF™ Filter with Programmable

Gain/Attenuation

PrPb SSAF™

Separate Pedestal Control on Component and

Composite/S-Video Output

VCR FF/RW Sync Mode

Macrovision Rev 7.1.1.L*

CGMS/WSS

Closed Captioning

Standards Directly Supported

Resolution	Frame Rate (Hz)	Clk Input (MHz)	Standard
720 × 480	29.97	27	ITU-R BT.656
720 × 576	25	27	ITU-R BT.656
720 × 483	59.94	27	SMPTE 293M
720 × 480	59.94	27	BTA T-1004
720 × 576	50	27	ITU-R BT.1362
1280 × 720	60	74.25	SMPTE 296M
1920 × 1080	30	74.25	SMPTE 274M
1920 × 1080	25	74.25	SMPTE 274M*

Other standards are supported in Async Timing Mode.

*SMPTE 274M-1998: System no. 6

DETAILED FUNCTIONAL BLOCK DIAGRAM

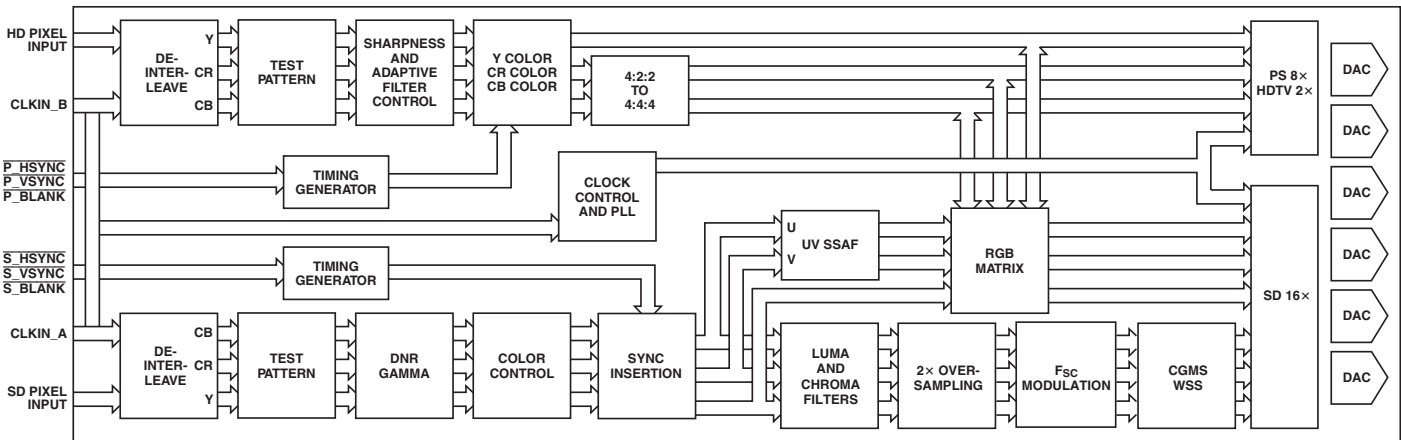

TERMINOLOGY

- SD** Standard Definition Video, conforming to ITU-R BT.601/ITU-R BT.656.
- HD** High Definition Video, i.e., Progressive Scan or HDTV.
- PS** Progressive Scan Video, conforming to SMPTE 293M, ITU-R BT.1358, BTAT-1004EDTV2, or BTA1362.

HDTV High Definition Television Video, conforming to SMPTE 274M or SMPTE 296M.

YCrCb SD, PS, or HD Component Digital Video.

YPrPb SD, PS, or HD Component Analog Video.

CONTENTS

FEATURES	1	PROGRAMMABLE DAC GAIN CONTROL	47
GENERAL FEATURES	1	Gamma Correction	48
APPLICATIONS	1	HD SHARPNESS FILTER CONTROL AND ADAPTIVE	
SIMPLIFIED FUNCTIONAL BLOCK DIAGRAM	1	FILTER CONTROL	49
GENERAL DESCRIPTION	1	HD Sharpness Filter Mode	49
DETAILED FEATURES	2	HD Adaptive Filter Mode	49
DETAILED FUNCTIONAL BLOCK DIAGRAM	2	HD Sharpness Filter and Adaptive Filter Application	
TERMINOLOGY	2	Examples	50
SPECIFICATIONS	4	SD Digital Noise Reduction	52
DYNAMIC SPECIFICATIONS	5	Coring Gain Border	53
TIMING SPECIFICATIONS	6	Coring Gain Data	53
Timing Diagrams	7	DNR Threshold	53
ABSOLUTE MAXIMUM RATINGS	14	Border Area	53
THERMAL CHARACTERISTICS	14	Block Size Control	53
ORDERING GUIDE	14	DNR Input Select Control	53
PIN CONFIGURATION	14	DNR Mode Control	53
PIN FUNCTION DESCRIPTIONS	15	Block Offset Control	53
MPU PORT DESCRIPTION	16	SD ACTIVE VIDEO EDGE	54
REGISTER ACCESSES	17	SAV/EAV Step Edge Control	54
Register Programming	17	BOARD DESIGN AND LAYOUT CONSIDERATIONS .	55
Subaddress Register (SR7–SR0)	17	DAC Termination and Layout Considerations	55
INPUT CONFIGURATION	30	Video Output Buffer and Optional Output Filter	55
Standard Definition Only	30	PCB Board Layout Considerations	57
Progressive Scan Only or HDTV Only	30	Supply Decoupling	57
Simultaneous Standard Definition and Progressive Scan		Digital Signal Interconnect	57
or HDTV	30	Analog Signal Interconnect	57
Progressive Scan at 27 MHz (Dual Edge) or 54 MHz ..	31	APPENDIX 1—COPY GENERATION MANAGEMENT	
OUTPUT CONFIGURATION	33	SYSTEM	59
TIMING MODES	34	PS CGMS Data Registers 2–0	59
HD Async Timing Mode	34	SD CGMS Data Registers 2–0	59
HD TIMING RESET	35	HD/PS CGMS [Address 12h, Bit 6]	59
SD Real-Time Control, Subcarrier Reset,		Function of CGMS Bits	59
and Timing Reset	36	CGMS Functionality	59
Reset Sequence	37	APPENDIX 2—SD WIDE SCREEN SIGNALING	61
SD VCR FF/RW Sync	37	APPENDIX 3—SD CLOSED CAPTIONING	62
Vertical Blanking Interval	38	APPENDIX 4—TEST PATTERNS	63
Subcarrier Frequency Registers	38	APPENDIX 5—SD TIMING MODES	66
Square Pixel Timing	38	Mode 0 (CCIR-656)—Slave Option	66
FILTER SECTION	39	Mode 0 (CCIR-656)—Master Option	67
HD Sinc Filter	39	Mode 1—Slave Option	68
SD Internal Filter Response	40	Mode 1—Master Option	69
Typical Performance Characteristics	41	Mode 2—Slave Option	70
COLOR CONTROLS AND RGB MATRIX	45	Mode 2—Master Option	71
HD Y Level, HD Cr Level, HD Cb Level	45	Mode 3—Master/Slave Option	72
HD RGB Matrix	45	APPENDIX 6—HD TIMING	73
Programming the RGB Matrix	45	APPENDIX 7—VIDEO OUTPUT LEVELS	74
SD Luma and Color Control	45	HD YPrPb Output Levels	74
SD Hue Adjust Value	46	RGB Output Levels	75
SD Brightness Control	46	YUV Output Levels	76
SD Brightness Detect	46	APPENDIX 8—VIDEO STANDARDS	80
Double Buffering	46	OUTLINE DIMENSIONS	82
		Revision History	83

ADV7310/ADV7311—SPECIFICATIONS

($V_{AA} = 2.375\text{ V} - 2.625\text{ V}$, $V_{DD} = 2.375\text{ V} - 2.625\text{ V}$;

$V_{DD_IO} = 2.375 - 3.6\text{ V}$, $V_{REF} = 1.235\text{ V}$, $R_{SET} = 3040\ \Omega$, $R_{LOAD} = 300\ \Omega$. All specifications T_{MIN} to T_{MAX} (0°C to 70°C), unless otherwise noted.)

Parameter	Min	Typ	Max	Unit	Test Conditions
STATIC PERFORMANCE¹					
Resolution		12		Bits	
Integral Nonlinearity		1.5		LSB	
Differential Nonlinearity ² , +ve		0.25		LSB	
Differential Nonlinearity ² , -ve		1.5		LSB	
DIGITAL OUTPUTS					
Output Low Voltage, V_{OL}			0.4 [0.4] ³	V	$I_{SINK} = 3.2\text{ mA}$ $I_{SOURCE} = 400\ \mu\text{A}$ $V_{IN} = 0.4\text{ V}, 2.4\text{ V}$
Output High Voltage, V_{OH}	2.4[2.0] ³			V	
Three-State Leakage Current		± 1.0		μA	
Three-State Output Capacitance		2		pF	
DIGITAL AND CONTROL INPUTS					
Input High Voltage, V_{IH}	2			V	$V_{IN} = 2.4\text{ V}$
Input Low Voltage, V_{IL}			0.8	V	
Input Leakage Current		3		μA	
Input Capacitance, C_{IN}		2		pF	
ANALOG OUTPUTS					
Full-Scale Output Current	4.1	4.33	4.6	mA	
Output Current Range	4.1	4.33	4.6	mA	
DAC-to-DAC Matching		1.0		%	
Output Compliance Range, V_{OC}	0	1.0	1.4	V	
Output Capacitance, C_{OUT}		7		pF	
VOLTAGE REFERENCE					
Internal Reference Range, V_{REF}	1.15	1.235	1.3	V	
External Reference Range, V_{REF}	1.15	1.235	1.3	V	
V_{REF} Current ⁴		± 10		μA	
POWER REQUIREMENTS					
Normal Power Mode					
I_{DD} ⁵		170		mA	SD Only [16×] PS Only [8×] HDTV Only [2×] SD[16×, 10-bit] + PS[8×, 20-bit]
		110		mA	
		95		mA	
		172	190 ⁸	mA	
I_{DD_IO}		1.0		mA	
I_{AA} ^{6,7}		39	45	mA	
Sleep Mode					
I_{DD}		200		μA	
I_{AA}		10		μA	
I_{DD_IO}		250		μA	
POWER SUPPLY REJECTION RATIO					
		0.01		% / %	

NOTES

¹Oversampling disabled. Static DAC performance will be improved with increased oversampling ratios.

²DNL measures the deviation of the actual DAC output voltage step from the ideal. For +ve DNL, the actual step value lies above the ideal step value; for -ve DNL, the actual step value lies below the ideal step value.

³Value in brackets for $V_{DD_IO} = 2.375\text{ V} - 2.75\text{ V}$.

⁴External current required to overdrive internal V_{REF} .

⁵ I_{DD} , the circuit current, is the continuous current required to drive the digital core.

⁶ I_{AA} is the total current required to supply all DACs including the V_{REF} circuitry and the PLL circuitry.

⁷All DACs on.

⁸Guaranteed maximum by characterization.

Specifications subject to change without notice.

DYNAMIC SPECIFICATIONS ($V_{AA} = 2.375\text{ V} - 2.625\text{ V}$, $V_{DD} = 2.375\text{ V} - 2.625\text{ V}$; $V_{DD_IO} = 2.375\text{ V} - 3.6\text{ V}$, $V_{REF} = 1.235\text{ V}$, $R_{SET} = 3040\ \Omega$, $R_{LOAD} = 300\ \Omega$. All specifications T_{MIN} to T_{MAX} (0°C to 70°C), unless otherwise noted.)

Parameter	Min	Typ	Max	Unit	Test Conditions	
PROGRESSIVE SCAN MODE						
Luma Bandwidth		12.5		MHz	Luma ramp unweighted Flat field full bandwidth	
Chroma Bandwidth		5.8		MHz		
SNR		65.6		dB		
		72		dB		
HDTV MODE						
Luma Bandwidth		30		MHz		
Chroma Bandwidth		13.75		MHz		
STANDARD DEFINITION MODE						
Hue Accuracy		0.2		°	Referenced to 40 IRE	
Color Saturation Accuracy		0.20		%		
Chroma Nonlinear Gain		0.84		±%		
Chroma Nonlinear Phase		-0.2		±°		
Chroma/Luma Intermodulation		0		±%		
Chroma/Luma Gain Inequality		96.7		±%		
Chroma/Luma Delay Inequality		-1.0		ns		
Luminance Nonlinearity		0.2		±%		
Chroma AM Noise		84		dB		
Chroma PM Noise		75.3		dB		
Differential Gain		0.25		%		NTSC
Differential Phase		0.2		°		NTSC
SNR		63.5		dB		Luma ramp
		77.7		dB		Flat field full bandwidth

Specifications subject to change without notice.

ADV7310/ADV7311

TIMING SPECIFICATIONS ($V_{AA} = 2.375\text{ V} - 2.625\text{ V}$, $V_{DD} = 2.375\text{ V} - 2.625\text{ V}$; $V_{DD_{10}} = 2.375\text{ V} - 3.6\text{ V}$, $V_{REF} = 1.235\text{ V}$, $R_{SET} = 3040\ \Omega$, $R_{LOAD} = 300\ \Omega$. All specifications T_{MIN} to T_{MAX} (0°C to 70°C), unless otherwise noted.)

Parameter	Min	Typ	Max	Unit	Test Conditions
MPU PORT¹					
SCLOCK Frequency	0		400	kHz	First clock generated after this period relevant for repeated start condition
SCLOCK High Pulsewidth, t_1	0.6			μs	
SCLOCK Low Pulsewidth, t_2	1.3			μs	
Hold Time (Start Condition), t_3	0.6			μs	
Setup Time (Start Condition), t_4	0.6			μs	
Data Setup Time, t_5	100			ns	
SDATA, SCLOCK Rise Time, t_6			300	ns	
SDATA, SCLOCK Fall Time, t_7			300	ns	
Setup Time (Stop Condition), t_8	0.6			μs	
RESET Low Time	100			ns	
ANALOG OUTPUTS					
Analog Output Delay ²		7		ns	
Output Skew		1		ns	
CLOCK CONTROL AND PIXEL PORT³					
f_{CLK}			27	MHz	Progressive scan mode HDTV mode/async mode
f_{CLK}		81		MHz	
Clock High Time, t_9	40			% of one clk cycle	
Clock Low Time, t_{10}	40			% of one clk cycle	
Data Setup Time, t_{11}^1	2.0			ns	
Data Hold Time, t_{12}^1	2.0			ns	
SD Output Access Time, t_{13}			15	ns	
SD Output Hold Time, t_{14}	5.0			ns	
HD Output Access Time, t_{13}			14	ns	
HD Output Hold Time, t_{14}	5.0			ns	
PIPELINE DELAY⁴		63		clk cycles	SD [2×, 16×]
		76		clk cycles	SD component mode [16×]
		35		clk cycles	PS [1×]
		41		clk cycles	PS [8×]
		36		clk cycles	HD[2×, 1×]

NOTES

¹Guaranteed by characterization.

²Output delay measured from the 50% point of the rising edge of CLOCK to the 50% point of DAC output full-scale transition.

³Data: C[9:0]; Y[9:0], S[9:0]

Control: $\overline{P_HSYNC}$, $\overline{P_VSYNC}$, $\overline{P_BLANK}$, $\overline{S_HSYNC}$, $\overline{S_VSYNC}$, $\overline{S_BLANK}$.

⁴SD, PS = 27 MHz, HD = 74.25 MHz.

Specifications subject to change without notice.

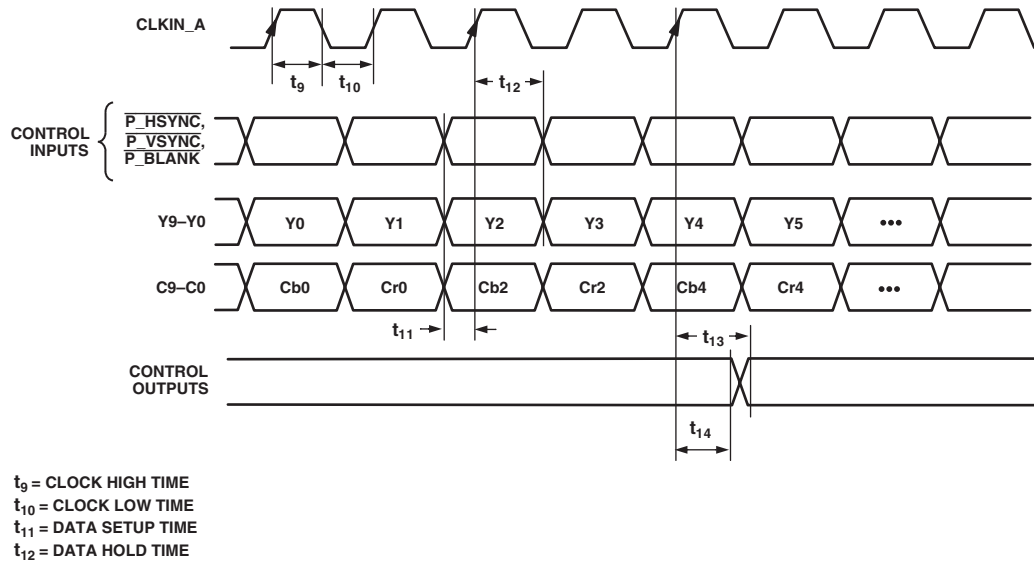

Figure 1. HD Only 4:2:2 Input Mode [Input Mode 010]; PS Only 4:2:2 Input Mode [Input Mode 001]

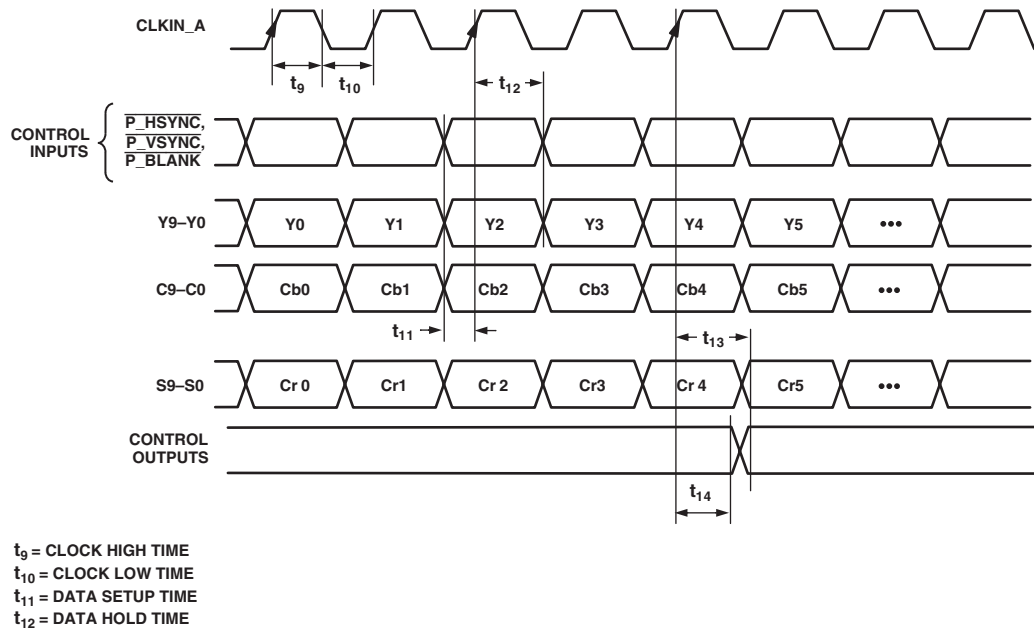

Figure 2. HD Only 4:4:4 Input Mode [Input Mode 010]; PS Only 4:4:4 Input Mode [Input Mode 001]

ADV7310/ADV7311

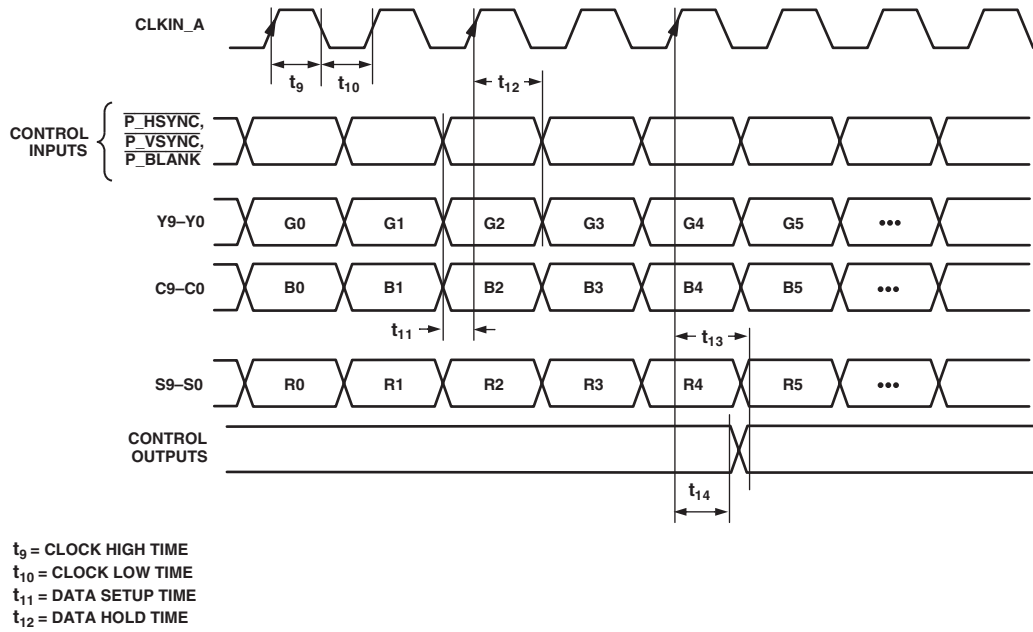

Figure 3. HD RGB 4:4:4 Input Mode [Input Mode 010]

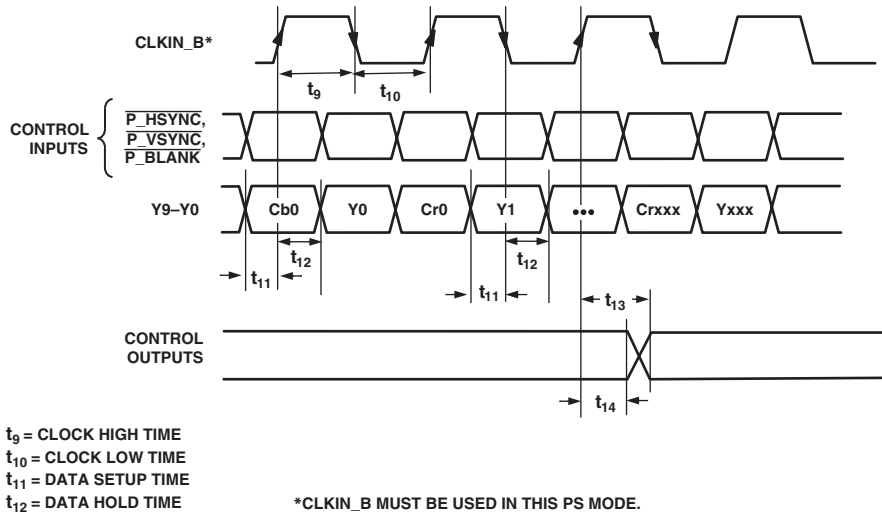
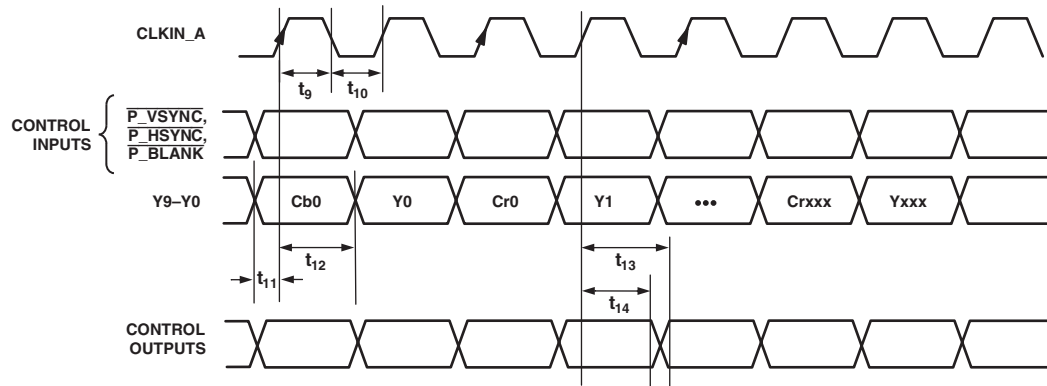
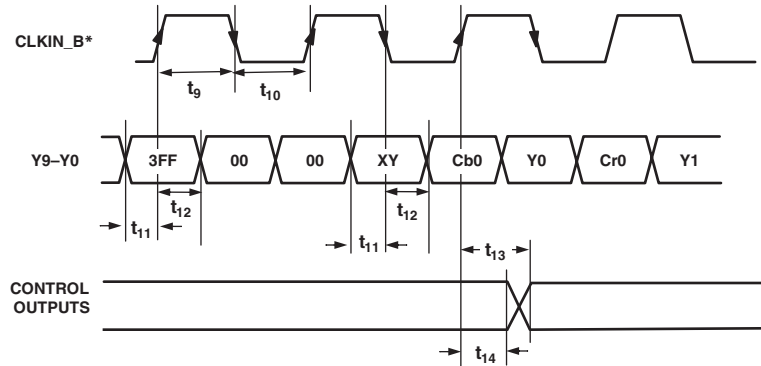

Figure 4. PS 4:2:2 10-Bit Interleaved at 27 MHz $\overline{\text{HSYNC}}/\overline{\text{VSYNC}}$ Input Mode [Input Mode 100]



t_9 = CLOCK HIGH TIME
 t_{10} = CLOCK LOW TIME
 t_{11} = DATA SETUP TIME
 t_{12} = DATA HOLD TIME

Figure 5. PS 4:2:2 1 × 10-Bit Interleaved at 54 MHz $\overline{\text{HSYNC}}/\overline{\text{VSYNC}}$ Input Mode [Input Mode 111]



t_9 = CLOCK HIGH TIME
 t_{10} = CLOCK LOW TIME
 t_{11} = DATA SETUP TIME
 t_{12} = DATA HOLD TIME

*CLKIN_B USED IN THIS PS ONLY MODE.

Figure 6. PS Only 4:2:2 1 × 10-Bit Interleaved at 27 MHz EAV/SAV Input Mode [Input Mode 100]

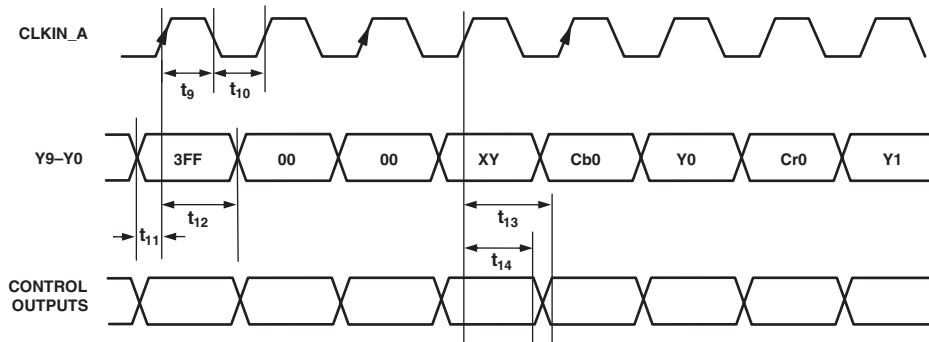

t_9 = CLOCK HIGH TIME
 t_{10} = CLOCK LOW TIME
 t_{11} = DATA SETUP TIME
 t_{12} = DATA HOLD TIME

NOTE: Y0, Cb0 SEQUENCE AS PER SUBADDRESS 0 × 01 BIT-1

Figure 7. PS Only 4:2:2 1 × 10-Bit Interleaved at 54 MHz EAV/SAV Input Mode [Input Mode 111]

ADV7310/ADV7311

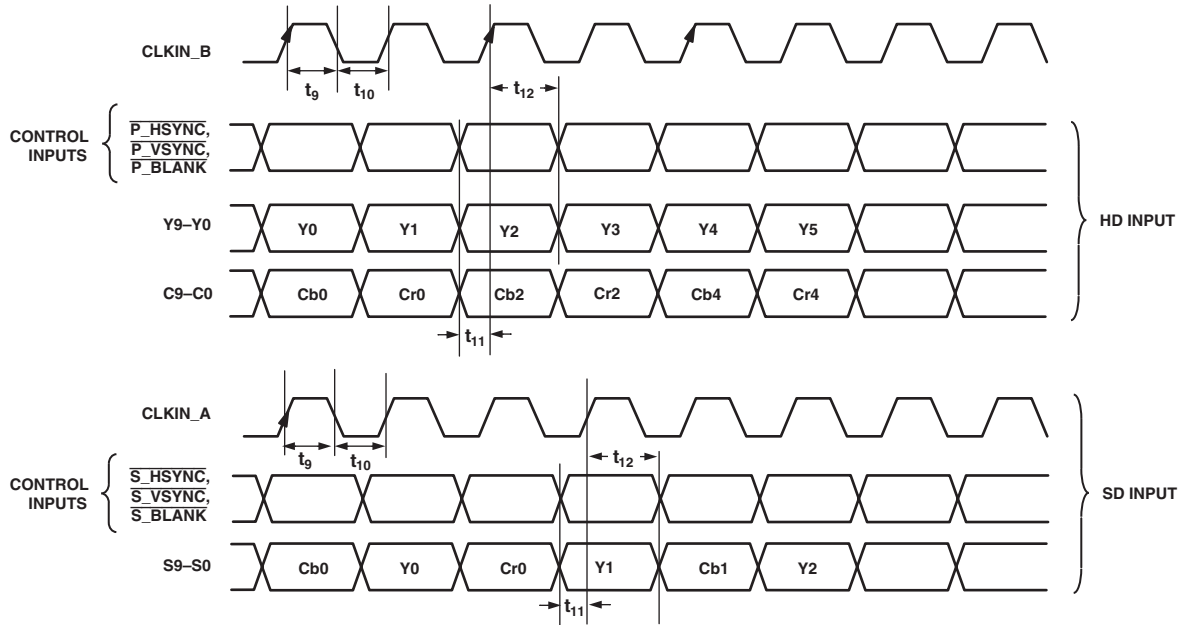

Figure 8. HD 4:2:2 and SD (10-Bit) Simultaneous Input Mode [Input Mode 101: SD Oversampled]
[Input Mode 110: HD Oversampled]

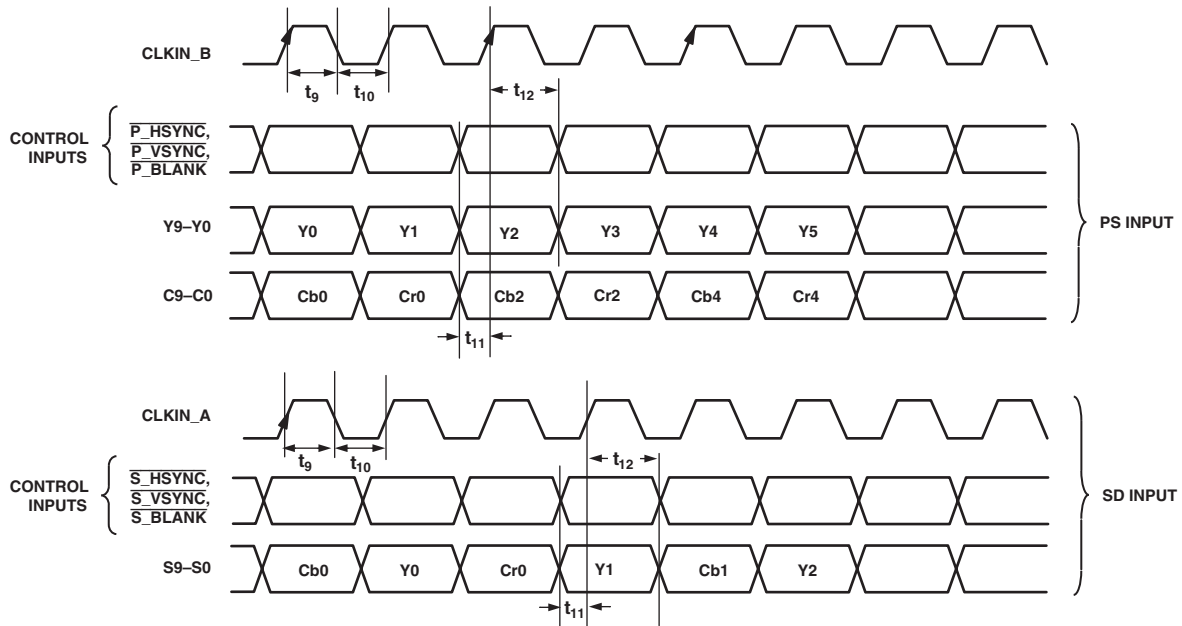

Figure 9. PS (4:2:2) and SD (10-Bit) Simultaneous Input Mode [Input Mode 011]

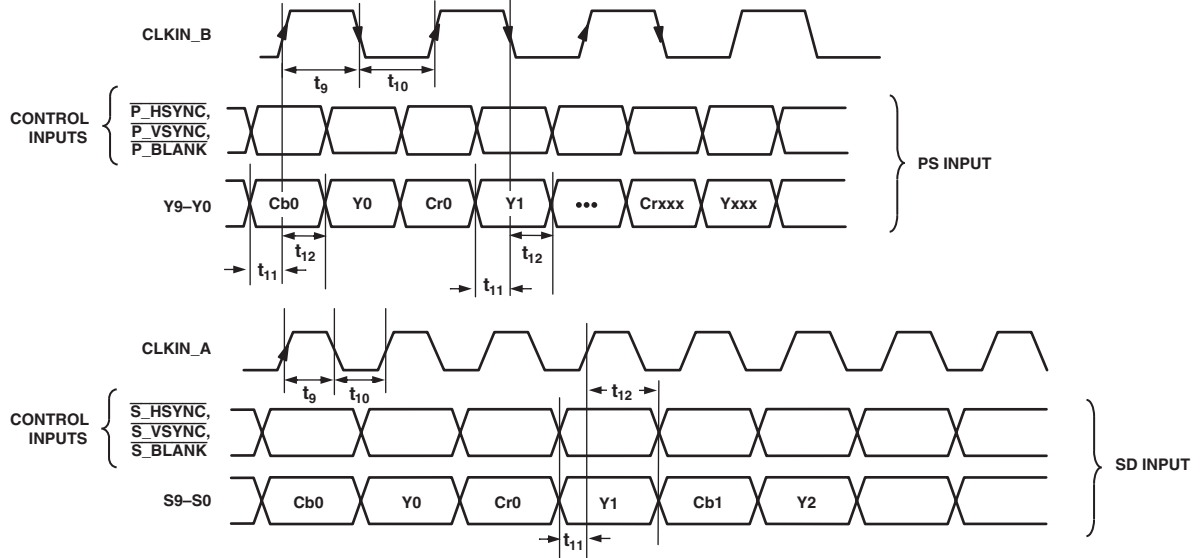
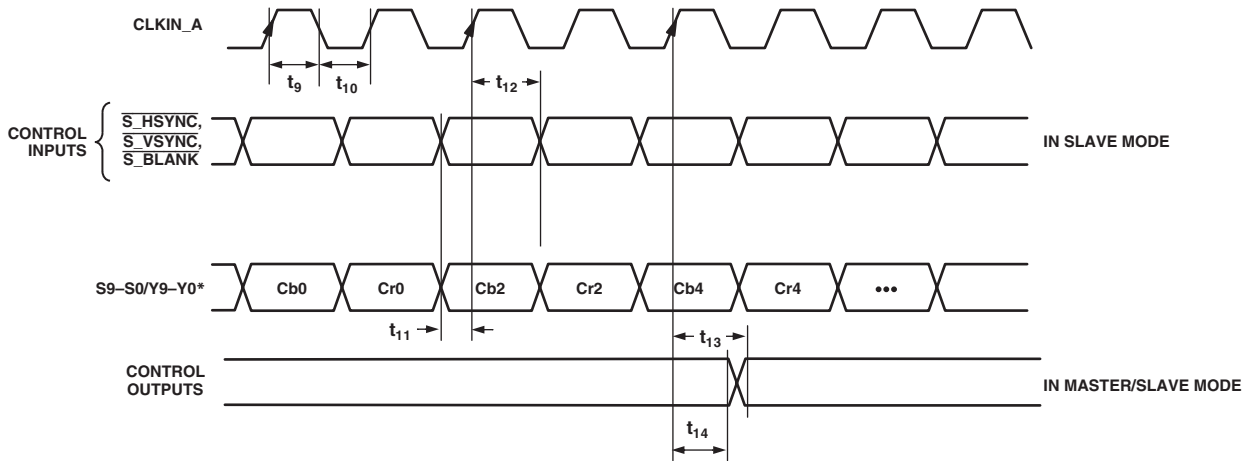

Figure 10. PS (10-Bit) and SD (10-Bit) Simultaneous Input Mode [Input Mode 100]



*SELECTED BY ADDRESS 0x01 BIT 7

Figure 11. 10-/8-Bit SD Only Pixel Input Mode [Input Mode 000]

ADV7310/ADV7311

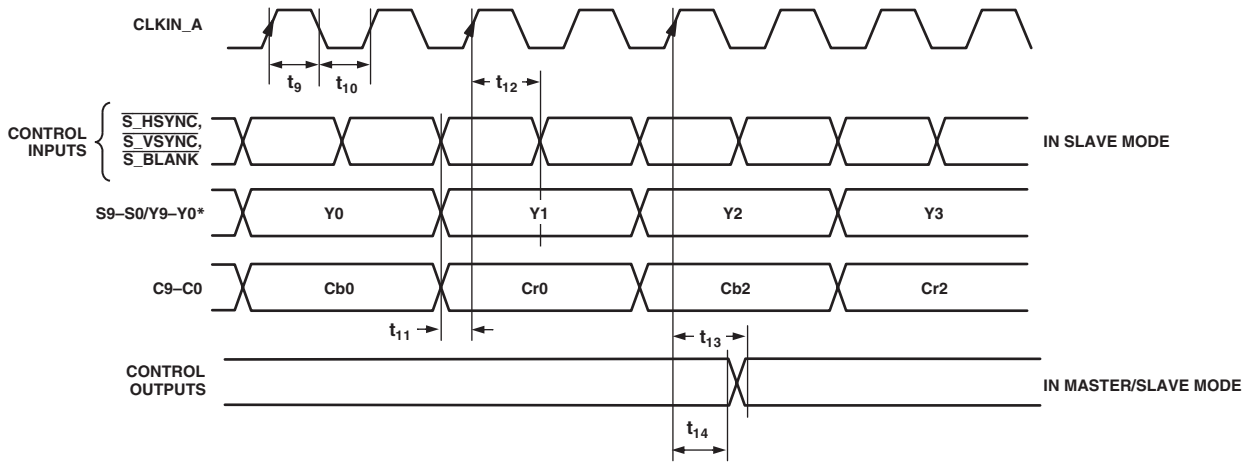

*SELECTED BY ADDRESS 0x01 BIT 7

Figure 12. 20-/16-Bit SD Only Pixel Input Mode [Input Mode 000]

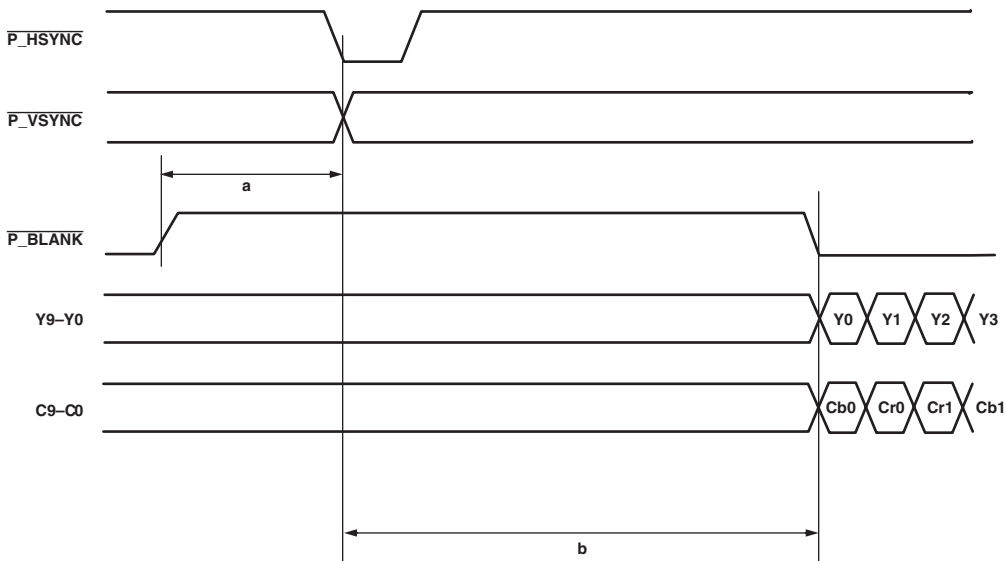

a = 16 CLKCYCLES FOR 525p
a = 12 CLKCYCLES FOR 625p
a = 44 CLKCYCLES FOR 1080i @ 30Hz, 25Hz
a = 70 CLKCYCLES FOR 720p
AS RECOMMENDED BY STANDARD

b(MIN) = 122 CLKCYCLES FOR 525p
b(MIN) = 132 CLKCYCLES FOR 625p
b(MIN) = 236 CLKCYCLES FOR 1080i @ 30Hz, 25Hz
b(MIN) = 300 CLKCYCLES FOR 720p

Figure 13. HD 4:2:2 Input Timing Diagram

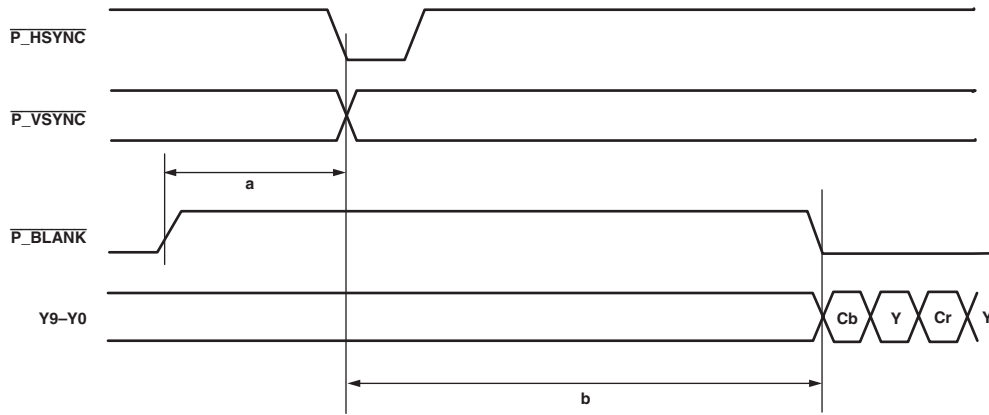

a = 32 CLKCYCLES FOR 525p
 a = 24 CLKCYCLES FOR 625p
 AS RECOMMENDED BY STANDARD
 b(MIN) = 244 CLKCYCLES FOR 525p
 b(MIN) = 264 CLKCYCLES FOR 625p

Figure 14. PS 4:2:2 1 × 10-Bit Interleaved Input Timing Diagram

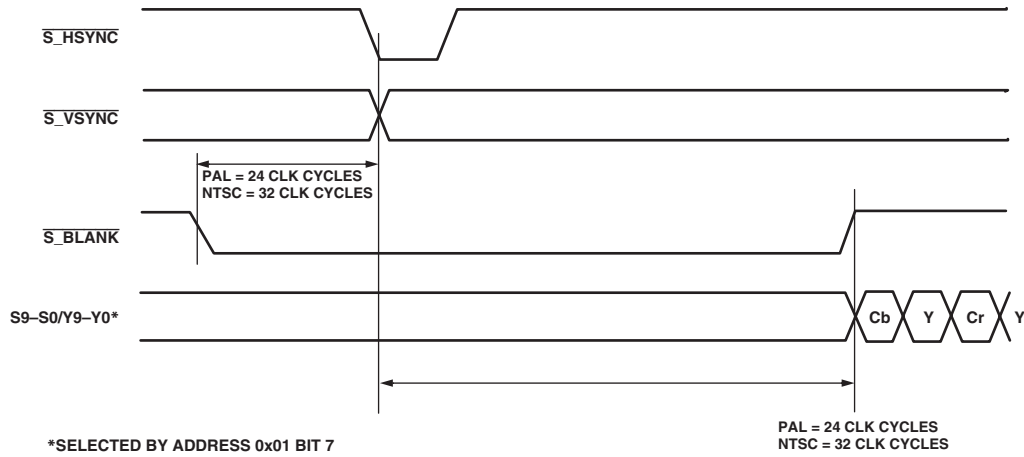

Figure 15. SD Timing Input for Timing Mode 1

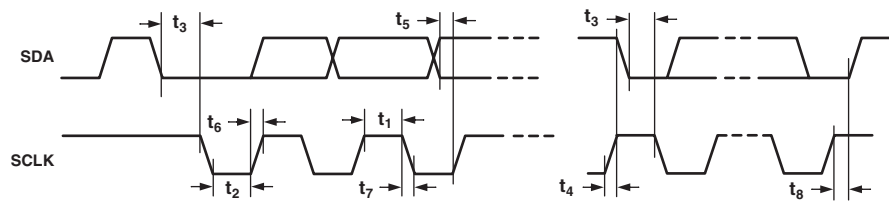

Figure 16. MPU Port Timing Diagram

ADV7310/ADV7311

ABSOLUTE MAXIMUM RATINGS*

V _{AA} to AGND	+3.0 V to -0.3 V
V _{DD} to GND	+3.0 V to -0.3 V
V _{DD_IO} to IO_GND	-0.3 V to V _{DD_IO} to +0.3 V
Ambient Operating Temperature (T _A)	0°C to 70°C
Storage Temperature (T _S)	-65°C to +150°C
Infrared Reflow Soldering (20 sec)	260°C

*Stresses above those listed under Absolute Maximum Ratings may cause permanent damage to the device. This is a stress rating only; functional operation of the device at these or any other conditions above those listed in the operational sections of this specification is not implied. Exposure to absolute maximum rating conditions for extended periods may affect device reliability.

THERMAL CHARACTERISTICS

$$\theta_{JC} = 11^{\circ}\text{C}/\text{W}$$

$$\theta_{JA} = 47^{\circ}\text{C}/\text{W}$$

The ADV7310/ADV7311 is a Pb-free environmentally friendly product. It is manufactured using the most up-to-date materials and processes. The coating on the leads of each device is 100% pure Sn electroplate. The device is suitable for Pb-free applications, and is able to withstand surface-mount soldering at up to 255°C ($\pm 5^{\circ}\text{C}$).

In addition it is backward compatible with conventional SnPb soldering processes. This means that the electroplated Sn coating can be soldered with Sn/Pb solder pastes at conventional reflow temperatures of 220°C to 235°C.

ORDERING GUIDE*

Model	Package Description	Package Option
ADV7310KST	Plastic Quad Flat Package	ST-64
ADV7311KST	Plastic Quad Flat Package	ST-64
EVAL-ADV7310EB	Evaluation Board	
EVAL-ADV7311EB	Evaluation Board	

*Analog output short circuit to any power supply or common can be of an indefinite duration.

PIN CONFIGURATION

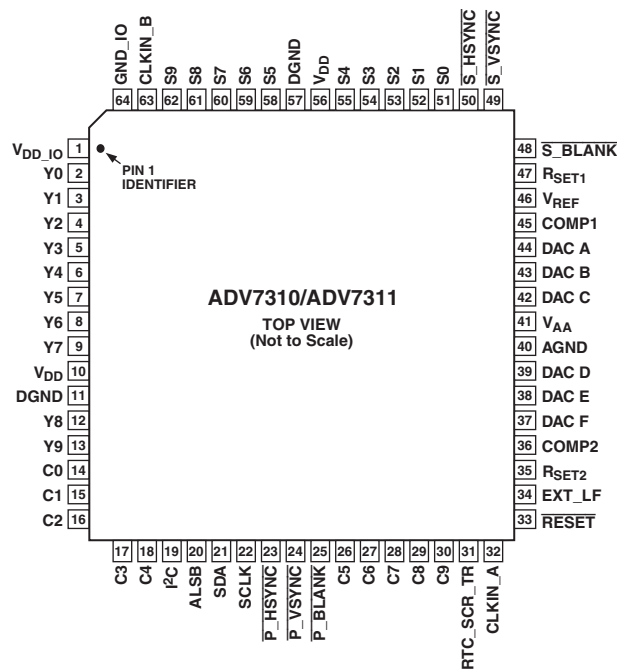

CAUTION

ESD (electrostatic discharge) sensitive device. Electrostatic charges as high as 4000 V readily accumulate on the human body and test equipment and can discharge without detection. Although the ADV7310/ADV7311 features proprietary ESD protection circuitry, permanent damage may occur on devices subjected to high energy electrostatic discharges. Therefore, proper ESD precautions are recommended to avoid performance degradation or loss of functionality.



PIN FUNCTION DESCRIPTIONS

Mnemonic	Input/Output	Function
DGND	G	Digital Ground.
AGND	G	Analog Ground.
CLKIN_A	I	Pixel Clock Input for HD (74.25 MHz Only, PS Only (27 MHz), SD Only (27 MHz).
CLKIN_B	I	Pixel Clock Input. Requires a 27 MHz reference clock for progressive scan mode or a 74.25 MHz (74.1758 MHz) reference clock in HDTV mode. This clock is only used in dual modes.
COMP1,2	O	Compensation Pin for DACs. Connect 0.1 μ F capacitor from COMP pin to V _{AA} .
DAC A	O	CVBS/Green/Y/Y Analog Output.
DAC B	O	Chroma/Blue/U/Pb Analog Output.
DAC C	O	Luma/Red/V/Pr Analog Output.
DAC D	O	In SD Only Mode: CVBS/Green/Y Analog Output; in HD Only Mode and Simultaneous HD/SD Mode: Y/Green [HD] Analog Output.
DAC E	O	In SD Only Mode: Luma/Blue/U Analog Output; in HD Only Mode and Simultaneous HD/SD Mode: Pr/Red Analog Output.
DAC F	O	In SD Only Mode: Chroma/Red/V Analog Output; in HD Only Mode and Simultaneous HD/SD Mode: Pb/Blue [HD] Analog Output.
$\overline{\text{P_HSYNC}}$	I	Video Horizontal Sync Control Signal for HD in Simultaneous SD/HD Mode and HD Only Mode.
$\overline{\text{P_VSYNC}}$	I	Video Vertical Sync Control Signal for HD in Simultaneous SD/HD Mode and HD Only Mode.
$\overline{\text{P_BLANK}}$	I	Video Blanking Control Signal for HD in Simultaneous SD/HD Mode and HD Only Mode.
$\overline{\text{S_BLANK}}$	I/O	Video Blanking Control Signal for SD Only.
$\overline{\text{S_HSYNC}}$	I/O	Video Horizontal Sync Control Signal for SD Only.
$\overline{\text{S_VSYNC}}$	I/O	Video Vertical Sync Control Signal for SD Only.
Y9–Y0	I	SD or Progressive Scan/HDTV Input Port for Y Data. Input port for interleaved progressive scan data. The LSB is set up on Pin Y0. For 8-bit data input, LSB is set up on Y2.
C9–C0	I	Progressive Scan/HDTV Input Port 4:4:4 Input Mode. This port is used for the Cb[Blue/U] data. The LSB is set up on pin C0. For 8-bit data input, LSB is set up on C2.
S9–S0	I	SD or Progressive Scan/HDTV Input Port for Cr[Red/V] data in 4:4:4 input mode. LSB is set up on pin S0. For 8-bit data input, LSB is set up on S2.
$\overline{\text{RESET}}$	I	This input resets the on-chip timing generator and sets the ADV7310/ADV7311 into default register setting. $\overline{\text{RESET}}$ is an active low signal.
R _{SET1,2}	I	A 3040 Ω resistor must be connected from this pin to AGND and is used to control the amplitudes of the DAC outputs.
SCLK	I	I ² C Port Serial Interface Clock Input.
SDA	I/O	I ² C Port Serial Data Input/Output.
ALS _B	I	TTL Address Input. This signal sets up the LSB of the I ² C address. When this pin is tied low, the I ² C filter is activated, which reduces noise on the I ² C interface.
V _{DD_IO}	P	Power Supply for Digital Inputs and Outputs.
V _{DD}	P	Digital Power Supply.
V _{AA}	P	Analog Power Supply.
V _{REF}	I/O	Optional External Voltage Reference Input for DACs or Voltage Reference Output (1.235 V).
EXT_LF	I	External Loop Filter for the Internal PLL.
RTC_SCR_TR	I	Multifunctional Input. Real time control (RTC) input, timing reset input, subcarrier reset input.
I ² C	I	This input pin must be tied high (V _{DD_IO}) for the ADV7310/ADV7311 to interface over the I ² C port.
GND_IO		Digital Input/Output Ground.

ADV7310/ADV7311

MPU PORT DESCRIPTION

The ADV7310/ADV7311 support a 2-wire serial (I²C compatible) microprocessor bus driving multiple peripherals. Two inputs, serial data (SDA) and serial clock (SCL), carry information between any device connected to the bus and the ADV7310/ADV7311. Each slave device is recognized by a unique address. The ADV7310/ADV7311 have four possible slave addresses for both read and write operations. These are unique addresses for each device and are illustrated in Figure 17. The LSB sets either a read or write operation. Logic 1 corresponds to a read operation, while Logic 0 corresponds to a write operation. A1 is set by setting the ALSB pin of the ADV7310/ADV7311 to Logic 0 or Logic 1. When ALSB is set to 1, there is greater input bandwidth on the I²C lines, which allows high speed data transfers on this bus. When ALSB is set to 0, there is reduced input bandwidth on the I²C lines, which means that pulses of less than 50 ns will not pass into the I²C internal controller. This mode is recommended for noisy systems.

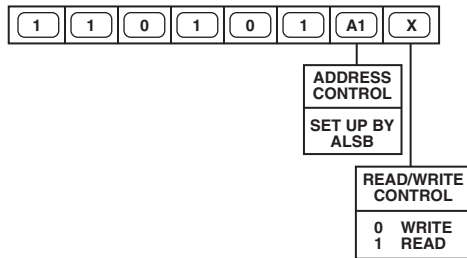

Figure 17. ADV7310 Slave Address = D4h

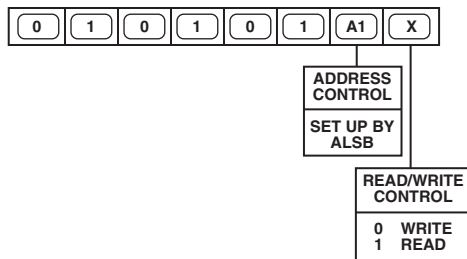

Figure 18. ADV7311 Slave Address = 54h

To control the various devices on the bus, the following protocol must be followed. First the master initiates a data transfer by establishing a start condition, defined by a high-to-low transition on SDA while SCL remains high. This indicates that an address/data stream will follow. All peripherals respond to the start condition and shift the next eight bits (7-bit address + R/W bit). The bits are transferred from MSB down to LSB. The peripheral that recognizes the transmitted address responds by pulling the data line low during the ninth clock pulse. This is known as an acknowledge bit. All other devices withdraw from the bus at this point and maintain an idle condition. The idle condition is where the device monitors the SDA and SCL lines waiting for the start condition and the correct transmitted address. The R/W bit determines the direction of the data.

A Logic 0 on the LSB of the first byte means that the master will write information to the peripheral. A Logic 1 on the LSB of the first byte means that the master will read information from the peripheral.

The ADV7310/ADV7311 acts as a standard slave device on the bus. The data on the SDA pin is 8 bits long, supporting the 7-bit addresses plus the R/W bit. It interprets the first byte as the device address and the second byte as the starting subaddress. There is a subaddress auto-increment facility. This allows data to be written to or read from registers in ascending subaddress sequence starting at any valid subaddress. A data transfer is always terminated by a stop condition. The user can also access any unique subaddress register on a one-by-one basis without having to update all the registers.

Stop and start conditions can be detected at any stage during the data transfer. If these conditions are asserted out of sequence with normal read and write operations, then they cause an immediate jump to the idle condition. During a given SCL high period, the user should only issue one start condition, one stop condition, or a single stop condition followed by a single start condition. If an invalid subaddress is issued by the user, the ADV7310/ADV7311 will not issue an acknowledge and will return to the idle condition. If in auto-increment mode the user exceeds the highest subaddress, the following action will be taken:

1. In read mode, the highest subaddress register contents will continue to be output until the master device issues a no-acknowledge. This indicates the end of a read. A no-acknowledge condition is when the SDA line is not pulled low on the ninth pulse.
2. In write mode, the data for the invalid byte will not be loaded into any subaddress register, a no-acknowledge will be issued by the ADV7310/ADV7311, and the part will return to the idle condition.

Before writing to the subcarrier frequency registers, it is a requirement that the ADV7310/ADV7311 has been reset at least once after power-up.

The four subcarrier frequency registers must be updated, starting with subcarrier frequency register 0 through subcarrier frequency register 3. The subcarrier frequency will not update until the last subcarrier frequency register byte has been received by the ADV7310/ADV7311.

Figure 19 illustrates an example of data transfer for a write sequence and the start and stop conditions. Figure 20 shows bus write and read sequences.

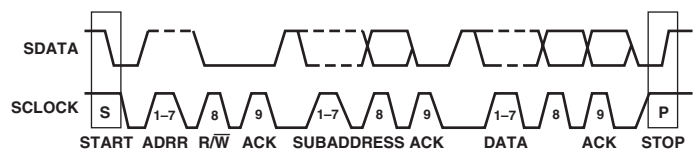

Figure 19. Bus Data Transfer

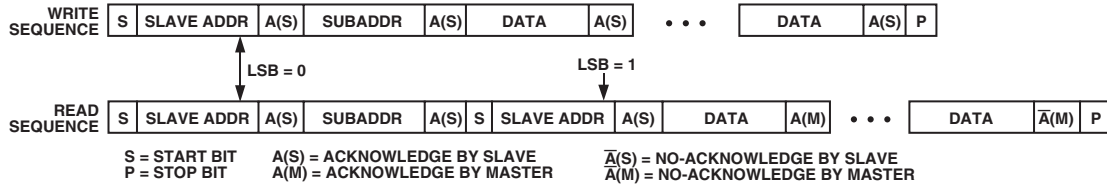

Figure 20. Read and Write Sequence

REGISTER ACCESSES

The MPU can write to or read from all of the registers of the ADV7310/ADV7311 except the subaddress registers, which are write only registers. The subaddress register determines which register the next read or write operation accesses. All communications with the part through the bus start with an access to the subaddress register. A read/write operation is then performed from/to the target address, which increments to the next address until a stop command is performed on the bus.

Register Programming

The following tables describe the functionality of each register. All registers can be read from as well as written to, unless otherwise stated.

Subaddress Register (SR7-SR0)

The communications register is an 8-bit write only register. After the part has been accessed over the bus and a read/write operation is selected, the subaddress is set up. The subaddress register determines to/from which register the operation takes place.

ADV7310/ADV7311

SR7-SR0	Register	Bit Description	Bit 7	Bit 6	Bit 5	Bit 4	Bit 3	Bit 2	Bit 1	Bit 0	Register Setting	Register Reset Values (Shaded)		
00h	Power Mode Register	Sleep Mode. With this control enabled, the current consumption is reduced to μ A level. All DACs and the internal PLL cct are disabled. I ² C registers can be read from and written to in Sleep Mode.								0	Sleep Mode off	FCh		
											1		Sleep Mode on	
		PLL and Oversampling Control. This control allows the internal PLL cct to be powered down and the over-sampling to be switched off.									0	PLL on		
											1	PLL off		
		DAC F: Power On/Off							0			DAC F off		
									1			DAC F on		
		DAC E: Power On/Off						0				DAC E off		
								1				DAC E on		
		DAC D: Power On/Off					0					DAC D off		
							1					DAC D on		
		DAC C: Power On/Off			0							DAC C off		
					1							DAC C on		
		DAC B: Power On/Off		0								DAC B off		
				1								DAC B on		
DAC A: Power On/Off	0									DAC A off				
	1									DAC A on				
01h	Mode Select Register	BTA T-1004 or BT.1362 Compatibility								0	Disabled	Only for PS dual edge clk mode		
										1	Enabled			
		Clock Edge								0		Cb clocked on rising edge	Only for PS interleaved input at 27 MHz	
										1		Y clocked on rising edge		
		Reserved						0						
		Clock Align						0						
								1					Must be set if the phase delay between the two input clocks is <9.25 ns or >27.75 ns.	Only if two input clocks are used
		Input Mode	0 0 0										SD input only	38h
			0 0 1										PS input only	
			0 1 0										HDTV input only	
			0 1 1										SD and PS [20-bit]	
			1 0 0										SD and PS [10-bit]	
			1 0 1										SD and HDTV [SD oversampled]	
			1 1 0										SD and HDTV [HDTV oversampled]	
1 1 1										PS only [at 54 MHz]				
Y/S Bus Swap	0										10-bit data on S bus	SD Mode 10-bit/20-bit Modes		
	1										10-bit data on Y bus			

SR7-SR0	Register	Bit Description	Bit 7	Bit 6	Bit 5	Bit 4	Bit 3	Bit 2	Bit 1	Bit 0	Register Setting	Reset Values		
02h	Mode Register 0	Reserved							0	0	Zero must be written to these bits	20h		
		Test Pattern Black Bar							0			Disabled	0x11h, Bit 2 must also be enabled	
									1			Enabled		
		RGB Matrix							0				Disable Programmable RGB matrix	
									1				Enable Programmable RGB matrix	
		Sync on RGB ¹						0					No Sync	
								1					Sync on all RGB outputs	
		RGB/YUV Output				0							RGB component outputs	
				1							YUV component outputs			
SD Sync			0								No Sync output			
			1								Output SD Syncs on HSYNC output, VSYNC output, BLANK output			
HD Sync		0									No Sync output			
		1									Output HD Syncs on HSYNC output, VSYNC output, BLANK output			
03h	RGB Matrix 0								x	x	LSB for GY	03h		
04h	RGB Matrix 1							x	x			LSB for RV	F0h	
								x	x			LSB for BU		
					x	x								LSB for GV
		x	x											LSB for GU
05h	RGB Matrix 2	x	x	x	x	x	x	x	x	x	Bit 9-2 for GY	4Eh		
06h	RGB Matrix 3	x	x	x	x	x	x	x	x	x	Bit 9-2 for GU	0Eh		
07h	RGB Matrix 4	x	x	x	x	x	x	x	x	x	Bit 9-2 for GV	24h		
08h	RGB Matrix 5	x	x	x	x	x	x	x	x	x	Bit 9-2 for BU	92h		
09h	RGB Matrix 6	x	x	x	x	x	x	x	x	x	Bit 9-2 for RV	7Ch		
0Ah	DAC A, B, C Output Level ²	Positive Gain to DAC Output Voltage	0	0	0	0	0	0	0	0	0	0%	00h	
			0	0	0	0	0	0	0	0	1	+0.018%		
			0	0	0	0	0	0	0	1	0	0.036%		
												
			0	0	1	1	1	1	1	1	1	+7.382%		
			0	1	0	0	0	0	0	0	0	+7.5%		
		Negative Gain to DAC Output Voltage	1	1	0	0	0	0	0	0	0	-7.5%		
			1	1	0	0	0	0	0	0	1	-7.382%		
			1	0	0	0	0	0	0	1	0	-7.364%		
												
			1	1	1	1	1	1	1	1	1	-0.018%		
		0Bh	DAC D, E, F Output Level	Positive Gain to DAC Output Voltage	0	0	0	0	0	0	0	0		0
	0			0	0	0	0	0	0	0	1	+0.018%		
	0			0	0	0	0	0	0	1	0	0.036%		
												
	0			0	1	1	1	1	1	1	1	+7.382%		
	0			1	0	0	0	0	0	0	0	+7.5%		
Negative Gain to DAC Output Voltage	1			1	0	0	0	0	0	0	0	-7.5%		
	1			1	0	0	0	0	0	0	1	-7.382%		
	1			0	0	0	0	0	0	1	0	-7.364%		
												
	1			1	1	1	1	1	1	1	1	-0.018%		
0Ch	Reserved												00h	
0Dh	Reserved										00h			
0Eh	Reserved										00h			
0Fh	Reserved										00h			

NOTES

¹For more detail, refer to Appendix 7.

²For more detail on the programmable output levels, refer to the Programmable DAC Gain Control section.

ADV7310/ADV7311

SR7-SR0	Register	Bit Description	Bit 7	Bit 6	Bit 5	Bit 4	Bit 3	Bit 2	Bit 1	Bit 0	Register Setting	Reset Values	
10h	HD Mode Register 1	HD Output Standard							0	0	EIA770.2 output	00h	
									0	1	EIA770.1 output		
									1	0	Output levels for full input range		
									1	1	Reserved		
		HD Input Control Signals						0	0				$\overline{\text{HSYNC}}$, $\overline{\text{VSYNC}}$, BLANK
								0	1				EAV/SAV codes
								1	0				Async Timing Mode
								1	1				Reserved
		HD 625p					0						525p
							1						625p
		HD 720p				0							1080i
						1							720p
		HD BLANK Polarity		0									BLANK active high
				1									BLANK active low
HD Macrovision for 525p/625p		0								Macrovision off			
		1								Macrovision on			
11h	HD Mode Register 2	HD Pixel Data Valid								0	Pixel data valid off	00h	
										1	Pixel data valid on		
										0	Reserved		
		HD Test Pattern Enable							0				HD test pattern off
									1				HD test pattern on
		HD Test Pattern Hatch/Field					0						Hatch
							1						Field/frame
		HD VBI Open				0							Disabled
						1							Enabled
		HD Undershoot Limiter		0	0								Disabled
				0	1								-11 IRE
				1	0								-6 IRE
				1	1								-1.5 IRE
		HD Sharpness Filter		0									Disabled
	1									Enabled			
12h	HD Mode Register 3	HD Y Delay with Respect to Falling Edge of $\overline{\text{HSYNC}}$						0	0	0	0 clk cycles		
								0	0	1	1 clk cycles		
									0	1	0		2 clk cycles
									0	1	1		3 clk cycles
									1	0	0		4 clk cycles
		HD Color Delay with Respect to Falling Edge of $\overline{\text{HSYNC}}$			0	0	0						0 clk cycles
					0	0	1						1 clk cycle
					0	1	0						2 clk cycles
					0	1	1						3 clk cycles
		HD CGMS			1	0	0						4 clk cycles
				0									Disabled
				1									Enabled
		HD CGMS CRC		0									Disabled
				1									Enabled

SR7– SR0	Register	Bit Description	Bit 7	Bit 6	Bit 5	Bit 4	Bit 3	Bit 2	Bit 1	Bit 0	Register Setting	Reset Values		
13h	HD Mode Register 4	HD Cr/Cb Sequence								0	Cb after falling edge of HSYNC			
										1	Cr after falling edge of HSYNC			
		Reserved							0	0 must be written to this bit				
		HD Input Format							0	8-bit input				
									1	10-bit input				
		Sinc Filter on DAC D, E, F							0	Disabled				
									1	Enabled				
		Reserved				0					0 must be written to this bit			
		HD Chroma SSAF			0						Disabled			
					1						Enabled			
HD Chroma Input		0							4:4:4					
		1							4:2:2					
HD Double Buffering		0							Disabled					
		1							Enabled					
14h	HD Mode Register 5	HD Timing Reset								x	A low-high-low transition resets the internal HD timing counters	00h		
		1080i Frame Rate						0	0	30 Hz/2200 total samples/lines				
									0	1	25 Hz/2640 total samples/lines			
		Reserved		0	0	0	0				0 must be written to these bits			
		HD VSYNC/Field Input		0							0 = Field Input			
				1							1 = VSYNC Input			
Lines/Frame ¹		0							Update field/line counter					
		1							Field/line counter free running					
15h	HD Mode Register 6	Reserved								0	0 must be written to this bit	00h		
		HD RGB Input								0	Disabled			
											1		Enabled	
		HD Sync on PrPb								0	Disabled			
											1		Enabled	
		HD Color DAC Swap							0				DAC E = Pb; DAC F = Pr	
										1				DAC E = Pr; DAC F = Pb
		HD Gamma Curve A/B					0						Gamma Curve A	
								1						Gamma Curve B
		HD Gamma Curve Enable				0							Disabled	
					1						Enabled			
HD Adaptive Filter Mode ²			0							Mode A				
				1							Mode B			
HD Adaptive Filter Enable ²		0								Disabled				
			1								Enabled			

NOTES

¹When set to 0, the line and field counters automatically wrap around at the end of the field/frame of the standard selected. When set to 1, the field/line counters are free running and wrap around when external sync signals indicate so.

²Adaptive Filter mode is not available in PS only @ 54 MHz input mode.

ADV7310/ADV7311

SR7-SR0	Register	Bit Description	Bit 7	Bit 6	Bit 5	Bit 4	Bit 3	Bit 2	Bit 1	Bit 0	Register Setting	Reset Values	
16h	HD Y Level*		x	x	x	x	x	x	x	x	Y level value	A0h	
17h	HD Cr Level*		x	x	x	x	x	x	x	x	Cr level value	80h	
18h	HD Cb Level*		x	x	x	x	x	x	x	x	Cb level value	80h	
19h		Reserved										00h	
1Ah		Reserved										00h	
1Bh		Reserved										00h	
1Ch		Reserved										00h	
1Dh		Reserved										00h	
1Eh		Reserved										00h	
1Fh		Reserved										00h	
20h	HD Sharpness Filter Gain	HD Sharpness Filter Gain Value A					0	0	0	0	Gain A = 0	00h	
							0	0	0	1	Gain A = +1		
								
							0	1	1	1	Gain A = +7		
							1	0	0	0	Gain A = -8		
								
		HD Sharpness Filter Gain Value B	0	0	0	0							Gain B = 0
			0	0	0	1							Gain B = +1
		
			0	1	1	1							Gain B = +7
			1	0	0	0							Gain B = -8
		
											Gain B = -1		
21h	HD CGMS Data 0	HD CGMS Data Bits	0	0	0	0	C19	C18	C17	C16	CGMS 19-16	00h	
22h	HD CGMS Data 1	HD CGMS Data Bits	C15	C14	C13	C12	C11	C10	C9	C8	CGMS 15-8	00h	
23h	HD CGMS Data 2	HD CGMS Data Bits	C7	C6	C5	C4	C3	C2	C1	C0	CGMS 7-0	00h	
24h	HD Gamma A	HD Gamma Curve A Data Points	x	x	x	x	x	x	x	x	A0	00h	
25h	HD Gamma A	HD Gamma Curve A Data Points	x	x	x	x	x	x	x	x	A1	00h	
26h	HD Gamma A	HD Gamma Curve A Data Points	x	x	x	x	x	x	x	x	A2	00h	
27h	HD Gamma A	HD Gamma Curve A Data Points	x	x	x	x	x	x	x	x	A3	00h	
28h	HD Gamma A	HD Gamma Curve A Data Points	x	x	x	x	x	x	x	x	A4	00h	
29h	HD Gamma A	HD Gamma Curve A Data Points	x	x	x	x	x	x	x	x	A5	00h	
2Ah	HD Gamma A	HD Gamma Curve A Data Points	x	x	x	x	x	x	x	x	A6	00h	
2Bh	HD Gamma A	HD Gamma Curve A Data Points	x	x	x	x	x	x	x	x	A7	00h	
2Ch	HD Gamma A	HD Gamma Curve A Data Points	x	x	x	x	x	x	x	x	A8	00h	
2Dh	HD Gamma A	HD Gamma Curve A Data Points	x	x	x	x	x	x	x	x	A9	00h	
2Eh	HD Gamma B	HD Gamma Curve B Data Points	x	x	x	x	x	x	x	x	B0	00h	
2Fh	HD Gamma B	HD Gamma Curve B Data Points	x	x	x	x	x	x	x	x	B1	00h	
30h	HD Gamma B	HD Gamma Curve B Data Points	x	x	x	x	x	x	x	x	B2	00h	
31h	HD Gamma B	HD Gamma Curve B Data Points	x	x	x	x	x	x	x	x	B3	00h	
32h	HD Gamma B	HD Gamma Curve B Data Points	x	x	x	x	x	x	x	x	B4	00h	
33h	HD Gamma B	HD Gamma Curve B Data Points	x	x	x	x	x	x	x	x	B5	00h	
34h	HD Gamma B	HD Gamma Curve B Data Points	x	x	x	x	x	x	x	x	B6	00h	
35h	HD Gamma B	HD Gamma Curve B Data Points	x	x	x	x	x	x	x	x	B7	00h	
36h	HD Gamma B	HD Gamma Curve B Data Points	x	x	x	x	x	x	x	x	B8	00h	
37h	HD Gamma B	HD Gamma Curve B Data Points	x	x	x	x	x	x	x	x	B9	00h	

NOTES

Programmable gamma correction is not available in PS only @ 54 MHz input mode.

*For use with internal test pattern only.

SR7-SR0	Register	Bit Description	Bit 7	Bit 6	Bit 5	Bit 4	Bit 3	Bit 2	Bit 1	Bit 0	Register Setting	Reset Values	
38h	HD Adaptive Filter Gain 1	HD Adaptive Filter Gain 1 Value A					0	0	0	0	Gain A = 0	00h	
							0	0	0	1	Gain A = +1		
								
							0	1	1	1	Gain A = +7		
							1	0	0	0	Gain A = -8		
								
							1	1	1	1	Gain A = -1		
			HD Adaptive Filter Gain 1 Value B	0	0	0	0						Gain B = 0
		0		0	0	1					Gain B = +1		
			
		0		1	1	1					Gain B = +7		
		1		0	0	0					Gain B = -8		
			
		1		1	1	1					Gain B = -1		
39h	HD Adaptive Filter Gain 2	HD Adaptive Filter Gain 2 Value A					0	0	0	0	Gain A = 0	00h	
							0	0	0	1	Gain A = +1		
								
							0	1	1	1	Gain A = +7		
							1	0	0	0	Gain A = -8		
								
							1	1	1	1	Gain A = -1		
			HD Adaptive Filter Gain 2 Value B	0	0	0	0						Gain B = 0
		0		0	0	1					Gain B = +1		
			
		0		1	1	1					Gain B = +7		
		1		0	0	0					Gain B = -8		
			
		1		1	1	1					Gain B = -1		
3Ah	HD Adaptive Filter Gain 3	HD Adaptive Filter Gain 3 Value A					0	0	0	0	Gain A = 0	00h	
							0	0	0	1	Gain A = +1		
								
							0	1	1	1	Gain A = +7		
							1	0	0	0	Gain A = -8		
								
							1	1	1	1	Gain A = -1		
			HD Adaptive Filter Gain 3 Value B	0	0	0	0						Gain B = 0
		0		0	0	1					Gain B = +1		
			
		0		1	1	1					Gain B = +7		
		1		0	0	0					Gain B = -8		
			
		1		1	1	1					Gain B = -1		
3Bh	HD Adaptive Filter Threshold A	HD Adaptive Filter Threshold A Value	x	x	x	x	x	x	x	x	Threshold A	00h	
3Ch	HD Adaptive Filter Threshold B	HD Adaptive Filter Threshold B Value	x	x	x	x	x	x	x	x	Threshold B	00h	
3Dh	HD Adaptive Filter Threshold C	HD Adaptive Filter Threshold C Value	x	x	x	x	x	x	x	x	Threshold C	00h	

ADV7310/ADV7311

SR7-SR0	Register	Bit Description	Bit 7	Bit 6	Bit 5	Bit 4	Bit 3	Bit 2	Bit 1	Bit 0	Register Setting	Reset Values		
3Eh		Reserved										00h		
3Fh		Reserved										00h		
40h	SD Mode Register 0	SD Standard							0	0	NTSC	00h		
									0	1	PAL B, D, G, H, I			
										1	0		PAL M	
										1	1		PAL N	
		SD Luma Filter					0	0	0				LPF NTSC	
							0	0	1				LPF PAL	
							0	1	0				Notch NTSC	
							0	1	1				Notch PAL	
							1	0	0				SSAF Luma	
							1	0	1				Luma CIF	
							1	1	0				Luma QCIF	
							1	1	1				Reserved	
		SD Chroma Filter	0	0	0								1.3 MHz	
			0	0	1								0.65 MHz	
			0	1	0								1.0 MHz	
			0	1	1								2.0 MHz	
			1	0	0								Reserved	
			1	0	1								Chroma CIF	
			1	1	0								Chroma QCIF	
		1	1	1									3.0 MHz	
41h		Reserved										00h		
42h	SD Mode Register 1	SD PrPb SSAF								0	Disabled	08h		
										1	Enabled			
		SD DAC Output 1									0	Refer to output configuration section		
											1			
		SD DAC Output 2									0	Refer to output configuration section		
											1			
		SD Pedestal							0			Disabled		
									1			Enabled		
		SD Square Pixel					0					Disabled		
							1					Enabled		
		SD VCR FF/RW Sync				0						Disabled		
						1						Enabled		
SD Pixel Data Valid			0							Disabled				
			1							Enabled				
SD SAV/EAV Step Edge Control	0									Disabled				
	1									Enabled				
43h	SD Mode Register 2	SD Pedestal YPrPb Output								0	No pedestal on YUV	00h		
										1	7.5 IRE pedestal on YUV			
		SD Output Levels Y									0	Y = 700 mV/300 mV		
											1	Y = 714 mV/286 mV		
		SD Output Levels PrPb						0	0			700 mV p-p[PAL]; 1000 mV p-p[NTSC]		
								0	1			700 mV p-p		
								1	0			1000 mV p-p		
								1	1			648 mV p-p		
		SD VBI Open				0						Disabled		
						1						Enabled		
		SD CC Field Control	0	0								CC disabled		
			0	1								CC on odd field only		
			1	0								CC on odd field only		
			1	1								CC on both fields		
			Reserved	1								Reserved		

ADV7310/ADV7311

SR7-SR0	Register	Bit Description	Bit 7	Bit 6	Bit 5	Bit 4	Bit 3	Bit 2	Bit 1	Bit 0	Register Setting	Reset Values	
44h	SD Mode Register 3	SD VSYNC-3H								0	Disabled	00h	
										1	VSYNC = 2.5 lines [PAL] VSYNC = 3 lines [NTSC]		
		SD RTC/TR/SCR								0	0		Genlock disabled
										0	1		Subcarrier Reset
										1	0		Timing Reset
										1	1		RTC enabled
		SD Active Video Length							0				720 pixels
									1				710 [NTSC]/702[PAL]
		SD Chroma					0						Chroma enabled
							1						Chroma disabled
SD Burst				0						Enabled			
				1						Disabled			
SD Color Bars			0							Disabled			
			1							Enabled			
SD DAC Swap	0									DAC A = Luma, DAC B = Chroma			
	1									DAC A = Chroma, DAC B = Luma			
45h	Reserved										00h		
46h	Reserved										00h		
47h	SD Mode Register 4	SD PrPb Scale								0	Disabled	00h	
										1	Enabled		
		SD Y Scale								0	Disabled		
										1	Enabled		
		SD Hue Adjust							0		Disabled		
									1		Enabled		
		SD Brightness						0			Disabled		
								1			Enabled		
		SD Luma SSAF Gain				0					Disabled		
						1					Enabled		
Reserved			0							0 must be written to this bit			
Reserved		0								0 must be written to this bit			
Reserved	0									0 must be written to this bit			
48h	SD Mode Register 5	Reserved								0		00h	
		Reserved							0		0 must be written to this bit		
		SD Double Buffering							0		Disabled		
									1		Enabled		
		SD Input Format				0	0						8-bit Input
						0	1						16-bit Input
						1	0						10-bit Input
						1	1						20-bit Input
		SD Digital Noise Reduction			0								Disabled
					1								Enabled
SD Gamma Control		0								Disabled			
		1								Enabled			
SD Gamma Curve	0									Gamma Curve A			
	1									Gamma Curve B			
49h	SD Mode Register 6	SD Undershoot Limiter							0	0	Disabled	00h	
									0	1	- 11 IRE		
										1	0		- 6 IRE
										1	1		- 1.5 IRE
		Reserved							0		0 must be written to this bit		
		SD Black Burst Output on DAC Luma						0					Disabled
								1					Enabled
		SD Chroma Delay			0	0							Disabled
					0	1							4 clk cycles
					1	0							8 clk cycles
			1	1						Reserved			
Reserved		0								0 must be written to this bit			
Reserved	0									0 must be written to this bit			

ADV7310/ADV7311

SR7-SR0	Register	Bit Description	Bit 7	Bit 6	Bit 5	Bit 4	Bit 3	Bit 2	Bit 1	Bit 0	Register Setting	Reset Values	
4Ah	SD Timing Register 0	SD Slave/Master Mode								0	Slave Mode	08h	
											1		Master Mode
		SD Timing Mode							0	0			Mode 0
									0	1			Mode 1
									1	0			Mode 2
									1	1			Mode 3
		SD BLANK Input						0					Enabled
								1					Disabled
		SD Luma Delay				0	0						No delay
						0	1						2 clk cycles
				1	0					4 clk cycles			
				1	1					6 clk cycles			
SD Min. Luma Value			0							- 40 IRE			
			1							- 7.5 IRE			
SD Timing Reset	x	0	0	0	0	0	0	0	0	A low-high-low transition will reset the internal SD timing counters			
4Bh	SD Timing Register 1	SD HSYNC Width							0	0	Ta = 1 clk cycle	00h	
										0	1		Ta = 4 clk cycles
										1	0		Ta = 16 clk cycles
										1	1		Ta = 128 clk cycles
		SD HSYNC to VSYNC delay						0	0				Tb = 0 clk cycle
								0	1				Tb = 4 clk cycles
								1	0				Tb = 8 clk cycles
								1	1				Tb = 18 clk cycles
		SD HSYNC to VSYNC Rising Edge Delay [Mode 1 Only] VSYNC Width [Mode 2 Only]			x	0							Tc = Tb
					x	1							Tc = Tb + 32 us
					0	0							1 clk cycle
					0	1							4 clk cycles
					1	0							16 clk cycles
		HSYNC to Pixel Data Adjust			1	1							128 clk cycles
			0	0							0 clk cycles		
			0	1							1 clk cycle		
1	0								2 clk cycles				
		1	1						3 clk cycles				
4Ch	SD F _{sc} Register 0		x	x	x	x	x	x	x	x	Subcarrier Frequency Bit 7-0	16h	
4Dh	SD F _{sc} Register 1		x	x	x	x	x	x	x	x	Subcarrier Frequency Bit 15-8	7Ch	
4Eh	SD F _{sc} Register 2		x	x	x	x	x	x	x	x	Subcarrier Frequency Bit 23-16	F0h	
4Fh	SD F _{sc} Register 3		x	x	x	x	x	x	x	x	Subcarrier Frequency Bit 31-24	21h	
50h	SD F _{sc} Phase		x	x	x	x	x	x	x	x	Subcarrier Phase Bit 9-2	00h	
51h	SD Closed Captioning	Extended Data on Even Fields	x	x	x	x	x	x	x	x	Extended Data Bit 7-0	00h	
52h	SD Closed Captioning	Extended Data on Even Fields	x	x	x	x	x	x	x	x	Extended Data Bit 15-8	00h	
53h	SD Closed Captioning	Data on Odd Fields	x	x	x	x	x	x	x	x	Data Bit 7-0	00h	
54h	SD Closed Captioning	Data on Odd Fields	x	x	x	x	x	x	x	x	Data Bit 15-8	00h	
55h	SD Pedestal Register 0	Pedestal on Odd Fields	17	16	15	14	13	12	11	10	Setting any of these bits to 1 will disable pedestal on the line number indicated by the bit settings	00h	
56h	SD Pedestal Register 1	Pedestal on Odd Fields	25	24	23	22	21	20	19	18		00h	
57h	SD Pedestal Register 2	Pedestal on Even Fields	17	16	15	14	13	12	11	10		00h	
58h	SD Pedestal Register 3	Pedestal on Even Fields	25	24	23	22	21	20	19	18		00h	



Figure 21. Timing Register 1 in PAL Mode

SR7-SR0	Register	Bit Description	Bit 7	Bit 6	Bit 5	Bit 4	Bit 3	Bit 2	Bit 1	Bit 0	Register Setting	Reset Values	
59h	SD CGMS/WSS 0	SD CGMS Data				0	19	18	17	16	CGMS data bits C19-C16	00h	
		SD CGMS CRC				1					Disabled		
		SD CGMS on Odd Fields			0						Disabled		
					1						Enabled		
		SD CGMS on Even Fields		0							Disabled		
				1							Enabled		
SD WSS		0							Disabled				
		1							Enabled				
5Ah	SD CGMS/WSS 1	SD CGMS/WSS Data			13	12	11	10	9	8	CGMS data bits C13-C8 or WSS data bits C13-C8	00h	
			15	14							CGMS data bits C15-C14	00h	
5Bh	SD CGMS/WSS 2	SD CGMS/WSS Data	7	6	5	4	3	2	1	0	CGMS/WSS data bits C7-C0	00h	
5Ch	SD LSB Register	SD LSB for Y Scale Value							x	x	SD Y Scale Bit 1-0		
		SD LSB for U Scale Value					x	x			SD U Scale Bit 1-0		
		SD LSB for V Scale Value			x	x					SD V Scale Bit 1-0		
		SD LSB for F_{sc} Phase	x	x							Subcarrier Phase Bits 1-0		
5Dh	SD Y Scale Register	SD Y Scale Value	x	x	x	x	x	x	x	x	SD Y Scale Bit 7-2	00h	
5Eh	SD V Scale Register	SD V Scale Value	x	x	x	x	x	x	x	x	SD V Scale Bit 7-2	00h	
5Fh	SD U Scale Register	SD U Scale Value	x	x	x	x	x	x	x	x	SD U Scale Bit 7-2	00h	
60h	SD Hue Register	SD Hue Adjust Value	x	x	x	x	x	x	x	x	SD Hue Adjust Bit 7-0	00h	
61h	SD Brightness/WSS	SD Brightness Value		x	x	x	x	x	x	x	SD Brightness Bit 6-0	00h	
		SD Blank WSS Data	0								Disabled	Line 23	
			1							Enabled			
62h	SD Luma SSAF	SD Luma SSAF Gain/Attenuation	0	0	0	0	0	0	0	0	-4 dB	00h	
			0	0	0	0	0	1	1	0	0 dB		
			0	0	0	0	1	1	0	0	+4 dB		
63h	SD DNR 0	Coring Gain Border					0	0	0	0	No gain	00h	
							0	0	0	1	+1/16 [-1/8]		
							0	0	1	0	+2/16 [-2/8]		
							0	0	1	1	+3/16 [-3/8]		
							0	1	0	0	+4/16 [-4/8]		
							0	1	0	1	+5/16 [-5/8]		
							0	1	1	0	+6/16 [-6/8]		
							0	1	1	1	+7/16 [-7/8]		
						1	0	0	0	+8/16 [-1]			
		Coring Gain Data		0	0	0	0						No gain
				0	0	0	1						+1/16 [-1/8]
				0	0	1	0						+2/16 [-2/8]
				0	0	1	1						+3/16 [-3/8]
				0	1	0	0						+4/16 [-4/8]
				0	1	0	1						+5/16 [-5/8]
				0	1	1	0						+6/16 [-6/8]
	0		1	1	1					+7/16 [-7/8]			
	1	0	0	0					+8/16 [-1]				
64h	SD DNR 1	DNR Threshold			0	0	0	0	0	0	0	00h	
					0	0	0	0	0	1	1		
						
					1	1	1	1	1	0	62		
					1	1	1	1	1	1	63		
			Border Area		0						2 pixels		
				1						4 pixels			
		Block Size Control		0						8 pixels			
				1						16 pixels			

ADV7310/ADV7311

SR7-SR0	Register	Bit Description	Bit 7	Bit 6	Bit 5	Bit 4	Bit 3	Bit 2	Bit 1	Bit 0	Register Setting	Reset Values		
65h	SD DNR 2	DNR Input Select						0	0	1	Filter A	00h		
								0	1	0	Filter B			
								0	1	1	Filter C			
								1	0	0	Filter D			
		DNR Mode				0						DNR mode		
						1						DNR sharpness mode		
		DNR Block Offset	0	0	0	0							0 pixel offset	
			0	0	0	1							1 pixel offset	
			
			1	1	1	0							14 pixel offset	
		1	1	1	1						15 pixel offset			
66h	SD Gamma A	SD Gamma Curve A Data Points	x	x	x	x	x	x	x	x	A0	00h		
67h	SD Gamma A	SD Gamma Curve A Data Points	x	x	x	x	x	x	x	x	A1	00h		
68h	SD Gamma A	SD Gamma Curve A Data Points	x	x	x	x	x	x	x	x	A2	00h		
69h	SD Gamma A	SD Gamma Curve A Data Points	x	x	x	x	x	x	x	x	A3	00h		
6Ah	SD Gamma A	SD Gamma Curve A Data Points	x	x	x	x	x	x	x	x	A4	00h		
6Bh	SD Gamma A	SD Gamma Curve A Data Points	x	x	x	x	x	x	x	x	A5	00h		
6Ch	SD Gamma A	SD Gamma Curve A Data Points	x	x	x	x	x	x	x	x	A6	00h		
6Dh	SD Gamma A	SD Gamma Curve A Data Points	x	x	x	x	x	x	x	x	A7	00h		
6Eh	SD Gamma A	SD Gamma Curve A Data Points	x	x	x	x	x	x	x	x	A8	00h		
6Fh	SD Gamma A	SD Gamma Curve A Data Points	x	x	x	x	x	x	x	x	A9	00h		
70h	SD Gamma B	SD Gamma Curve B Data Points	x	x	x	x	x	x	x	x	B0	00h		
71h	SD Gamma B	SD Gamma Curve B Data Points	x	x	x	x	x	x	x	x	B1	00h		
72h	SD Gamma B	SD Gamma Curve B Data Points	x	x	x	x	x	x	x	x	B2	00h		
73h	SD Gamma B	SD Gamma Curve B Data Points	x	x	x	x	x	x	x	x	B3	00h		
74h	SD Gamma B	SD Gamma Curve B Data Points	x	x	x	x	x	x	x	x	B4	00h		
75h	SD Gamma B	SD Gamma Curve B Data Points	x	x	x	x	x	x	x	x	B5	00h		
76h	SD Gamma B	SD Gamma Curve B Data Points	x	x	x	x	x	x	x	x	B6	00h		
77h	SD Gamma B	SD Gamma Curve B Data Points	x	x	x	x	x	x	x	x	B7	00h		
78h	SD Gamma B	SD Gamma Curve B Data Points	x	x	x	x	x	x	x	x	B8	00h		
79h	SD Gamma B	SD Gamma Curve B Data Points	x	x	x	x	x	x	x	x	B9	00h		
7Ah	SD Brightness Detect	SD Brightness Value	x	x	x	x	x	x	x	x	Read only			
7Bh	Field Count Register	Field Count						x	x	x	Read only			
		Reserved					0				0 must be written to this bit			
		Reserved				0						0 must be written to this bit		
		Reserved			0							0 must be written to this bit		
	Revision Code		x	x							Read only			
7Ch	10-Bit Input		0	0	0	0	0	0	1	0	Must write this for 10-bit data input (SD, PS, HD)	00h		

ADV7310/ADV7311

SR7-SR0	Register	Bit Description	Bit 7	Bit 6	Bit 5	Bit 4	Bit 3	Bit 2	Bit 1	Bit 0	Register Setting	Reset Values
7Dh	Reserved											
7Eh	Reserved											
7Fh	Reserved											
80h	Macrovision	MV Control Bits	x	x	x	x	x	x	x	x		00h
81h	Macrovision	MV Control Bits	x	x	x	x	x	x	x	x		00h
82h	Macrovision	MV Control Bits	x	x	x	x	x	x	x	x		00h
83h	Macrovision	MV Control Bits	x	x	x	x	x	x	x	x		00h
84h	Macrovision	MV Control Bits	x	x	x	x	x	x	x	x		00h
85h	Macrovision	MV Control Bits	x	x	x	x	x	x	x	x		00h
86h	Macrovision	MV Control Bits	x	x	x	x	x	x	x	x		00h
87h	Macrovision	MV Control Bits	x	x	x	x	x	x	x	x		00h
88h	Macrovision	MV Control Bits	x	x	x	x	x	x	x	x		00h
89h	Macrovision	MV Control Bits	x	x	x	x	x	x	x	x		00h
8Ah	Macrovision	MV Control Bits	x	x	x	x	x	x	x	x		00h
8Bh	Macrovision	MV Control Bits	x	x	x	x	x	x	x	x		00h
8Ch	Macrovision	MV Control Bits	x	x	x	x	x	x	x	x		00h
8Dh	Macrovision	MV Control Bits	x	x	x	x	x	x	x	x		00h
8Eh	Macrovision	MV Control Bits	x	x	x	x	x	x	x	x		00h
8Fh	Macrovision	MV Control Bits	x	x	x	x	x	x	x	x		00h
90h	Macrovision	MV Control Bits	x	x	x	x	x	x	x	x		00h
91h	Macrovision	MV Control Bit								x		00h
			0	0	0	0	0	0	0		0 must be written to these bits	

NOTE

Macrovision registers only on the ADV7310.

ADV7310/ADV7311

INPUT CONFIGURATION

When 10-bit input data is applied, the following bits must be set to 1:

Address 0x7C, Bit 1 (Global 10-Bit Enable)

Address 0x13, Bit 2 (HD 10-Bit Enable)

Address 0x48, Bit 4 (SD 10-Bit Enable)

Note that the ADV7310 defaults to simultaneous standard definition and progressive scan on power-up.

Address[01h] : Input Mode = 011

Standard Definition Only

Address[01h] : Input Mode = 000

The 8-/10-bit multiplexed input data is input on Pins S9–S0 (or Y9–Y0, depending on Register Address 01h, Bit 7), with S0 being the LSB in 10-bit input mode. Input standards supported are ITU-R BT.601/656. In 16-bit input mode, the Y pixel data is input on Pins S9–S2 and CrCb data on Pins C9–C2. The 27 MHz clock input must be input on Pin CLKIN_A. Input sync signals are optional and are input on the $\overline{S_VSYNC}$, $\overline{S_HSYNC}$, and $\overline{S_BLANK}$ pins.

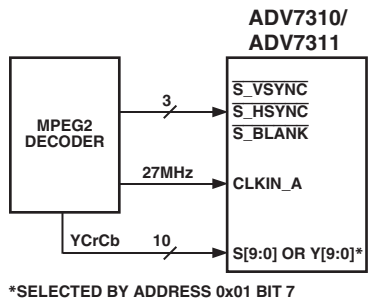

Figure 22. SD Only Input Mode

Progressive Scan Only or HDTV Only

Address[01h] Input Mode 001 or 010, Respectively

YCrCb progressive scan, HDTV, or any other HD YCrCb data can be input in 4:2:2 or 4:4:4. In 4:2:2 input mode, the Y data is input on Pins Y9–Y0 and the CrCb data on Pins C9–C0. In 4:4:4 input mode, Y data is input on Pins Y9–Y0, Cb data on Pins C9–C0, and Cr data on Pins S9–S0. If the YCrCb data does not conform to SMPTE 293M (525p), ITU-R BT.1358M (625p), SMPTE 274M[1080i], SMPTE 296M[720p], or BTA-T1004/1362, the async timing mode must be used. RGB data can only be input in 4:4:4 format in PS input mode only or HDTV input mode only when HD RGB input is enabled. G data is input on Pins Y9–Y0, R data on S9–S0, and B data on C9–C0. The clock signal must be input on Pin CLKIN_A.

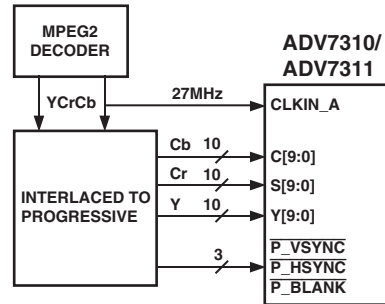

Figure 23. Progressive Scan Input Mode

Simultaneous Standard Definition and Progressive Scan or HDTV

Address[01h] : Input Mode 011(SD 10-Bit, PS 20-Bit) or 101(SD and HD, SD Oversampled), 110(SD and HD, HD Oversampled), Respectively

YCrCb, PS, HDTV, or any other HD data must be input in 4:2:2 format. In 4:2:2 input mode the HD Y data is input on Pins Y9–Y0 and the HD CrCb data on C9–C0. If PS 4:2:2 data is interleaved onto a single 10-bit bus, Y9–Y0 are used for the input port. The input data is to be input at 27 MHz, with the data being clocked on the rising and falling edge of the input clock. The input mode register at Address 01h is set accordingly. If the YCrCb data does not conform to SMPTE 293M (525p), ITU-R BT.1358M (625p), SMPTE 274M[1080i], SMPTE 296M[720p], or BTA-T1004, the async timing mode must be used.

The 8- or 10-bit standard definition data must be compliant with ITU-R BT.601/656 in 4:2:2 format. Standard definition data is input on Pins S9–S0, with S0 being the LSB. Using 8-bit input format, the data is input on Pins S9–S2. The clock input for SD must be input on CLKIN_A and the clock input for HD must be input on CLKIN_B. Synchronization signals are optional. SD syncs are input on Pins $\overline{S_VSYNC}$, $\overline{S_HSYNC}$, and $\overline{S_BLANK}$. HD syncs on Pins $\overline{P_VSYNC}$, $\overline{P_HSYNC}$, and $\overline{P_BLANK}$.

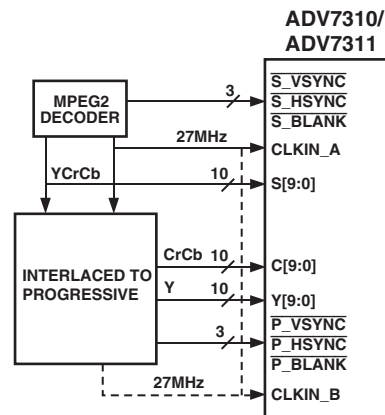

Figure 24. Simultaneous PS and SD Input

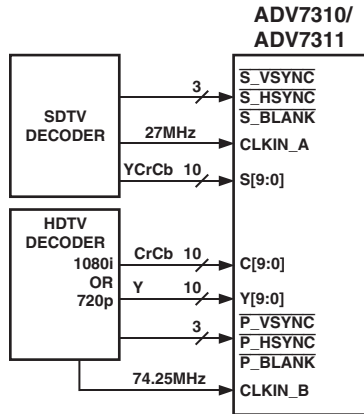

Figure 25. Simultaneous HD and SD Input

If in simultaneous SD/HD input mode the two clock phases differ by less than 9.25 ns or more than 27.75 ns, the CLOCK ALIGN bit [Address 01h Bit 3] must be set accordingly. If the application uses the same clock source for both SD and PS, the CLOCK ALIGN bit must be set since the phase difference between both inputs is less than 9.25 ns.

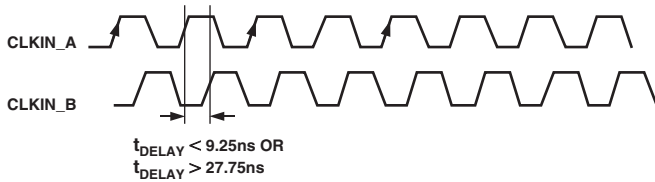

Figure 26. Clock Phase with Two Input Clocks

Progressive Scan at 27 MHz (Dual Edge) or 54 MHz

Address[01h] : Input Mode 100 or 111, Respectively

YCrCb progressive scan data can be input at 27 MHz or 54 MHz. The input data is interleaved onto a single 8-/10-bit bus and is input on Pins Y9–Y0. When a 27 MHz clock is supplied, the data is clocked in on the rising and falling edge of the input clock and CLOCK EDGE [Address 0x01, Bit 1] must be set accordingly.

The following figures show the possible conditions: (a) Cb data on the rising edge and (b) Y data on the rising edge.

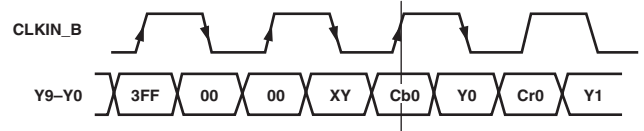

CLOCK EDGE ADDRESS 0x00 BIT 1 SHOULD BE SET TO 0 IN THIS CASE.

Figure 27a. Input Sequence in PS Bit Interleaved Mode (EAV/SAV)

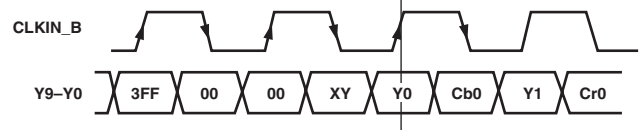

CLOCK EDGE ADDRESS 0x00 BIT 1 SHOULD BE SET TO 1 IN THIS CASE.

Figure 27b. Input Sequence in PS Bit Interleaved Mode (EAV/SAV)

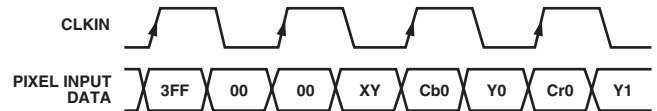

WITH A 54 MHz CLOCK, THE DATA IS LATCHED ON EVERY RISING EDGE.

Figure 27c. Input Sequence in PS Bit Interleaved Mode (EAV/SAV)

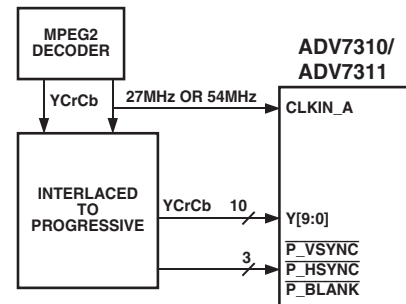

Figure 28. 1 × 10-Bit PS at 27 MHz or 54 MHz

Table I provides an overview of all possible input configurations.

Table I. Input Configurations

Input Format	Total Bits		Input Video	Input Pins	Subaddress	Register Setting
ITU-R BT.656	8	4:2:2	YCrCb	S9-S2 [MSB = S9]	01h 48h	00h 00h
	10	4:2:2	YCrCb	S9-S0 [MSB = S9]	01h 48h	00h 10h
	16	4:2:2	Y	S9-S2 [MSB = S9]	01h	00h
			CrCb	Y9-Y2 [MSB = Y9]	48h	08h
	20	4:2:2	Y	S9-S0 [MSB = S9]	01h	00h
			CrCb	Y9-Y0 [MSB = Y9]	48h	18h
8	4:2:2	YCrCb	Y9-Y2 [MSB = Y9]	01h 48h	80h 00h	
10	4:2:2	YCrCb	Y9-Y0 [MSB = Y9]	01h 48h	80h 10h	
PS Only	8 [27 MHz clock]	4:2:2	YCrCb	Y9-Y2 [MSB = Y9]	01h 13h	10h 40h
	10 [27 MHz clock]	4:2:2	YCrCb	Y9-Y0 [MSB = Y9]	01h 13h	10h 44h
	8 [54 MHz clock]	4:2:2	YCrCb	Y9-Y2 [MSB = Y9]	01h 13h	70h 40h
	10 [54 MHz clock]	4:2:2	YCrCb	Y9-Y0 [MSB = Y9]	01h 13h	70h 44h
	16	4:2:2	Y	Y9-Y2 [MSB = Y9]	01h	10h
			CrCb	C9-C2 [MSB = C9]	13h	40h
	20	4:2:2	Y	Y9-Y0 [MSB = Y9]	01h	10h
			CrCb	C9-C0 [MSB = C9]	13h	44h
	24	4:4:4	Y	Y9-Y2 [MSB = Y9]	01h	10h
			Cb	C9-C2 [MSB = C9]	13h	00h
Cr			S9-S2 [MSB = S9]			
30	4:4:4	Y	Y9-Y0 [MSB = Y9]	01h	10h	
		Cb	C9-C0 [MSB = C9]	13h	04h	
		Cr	S9-S0 [MSB = S9]			
HDTV Only	16	4:2:2	Y	Y9-Y2 [MSB = Y9]	01h	20h
			CrCb	C9-Y2 [MSB = C9]	13h	40h
	20	4:2:2	Y	Y9-Y0 [MSB = Y9]	01h	20h
			CrCb	C9-C0 [MSB = C9]	13h	44h
	24	4:4:4	Y	Y9-Y2 [MSB = Y9]	01h	20h
			Cb	C9-Y2 [MSB = C9]	13h	00h
			Cr	S9-S2 [MSB = S9]		
	30	4:4:4	Y	Y9-Y0 [MSB = Y9]	01h	20h
Cb			C9-C0 [MSB = C9]	13h	04h	
Cr			S9-S0 [MSB = S9]			
HD RGB	24	4:4:4	G	Y9-Y2 [MSB = Y9]	01h	10h or 20h
			B	C9-C2 [MSB = C9]	13h	00h
			R	S9-S2 [MSB = S9]	15h	02h
	30	4:4:4	G	Y9-Y0 [MSB = Y9]	01h	10h or 20h
			B	C9-C0 [MSB = C9]	13h	04h
			R	S9-S0 [MSB = S9]	15h	02h
ITU-R BT.656 and PS	8	4:2:2	YCrCb	S9-S2 [MSB = S9]	01h	40h
	8	4:2:2	YCrCb	Y9-Y2 [MSB = Y9]	13h	40h
ITU-R BT.656 and PS	10	4:2:2	YCrCb	S9-S0 [MSB = S9]	01h	40h
	10	4:2:2	YCrCb	Y9-Y0 [MSB = Y9]	13h 48h	44h 10h
ITU-R BT.656 and PS or HDTV	8	4:2:2	YCrCb	S9-S2 [MSB = S9]	01h	30h or 50h or 60h
	16	4:2:2	Y	Y9-Y2 [MSB = Y9]	13h	40h
			CrCb	C9-C2 [MSB = C9]	48h	00h
ITU-R BT.656 and PS or HDTV	10	4:2:2	YCrCb	S9-S0 [MSB = S9]	01h	30h or 50h or 60h
	20	4:2:2	Y	Y9-Y0 [MSB = Y9]	13h	44h
			CrCb	C9-C0 [MSB = C9]	48h	10h

OUTPUT CONFIGURATION

The tables below demonstrate what output signals are assigned to the DACs when the control bits are set accordingly.

Table II. Output Configuration in SD Only Mode

RGB/YUV Output 02h, Bit 5	SD DAC Output 1 42h, Bit 2	SD DAC Output 2 42h, Bit 1	DAC A	DAC B	DAC C	DAC D	DAC E	DAC F
0	0	0	CVBS	Luma	Chroma	G	B	R
0	0	1	G	B	R	CVBS	Luma	Chroma
0	1	0	G	Luma	Chroma	CVBS	B	R
0	1	1	CVBS	B	R	G	Luma	Chroma
1	0	0	CVBS	Luma	Chroma	Y	U	V
1	0	1	Y	U	V	CVBS	Luma	Chroma
1	1	0	Y	Luma	Chroma	CVBS	U	V
1	1	1	CVBS	U	V	Y	Luma	Chroma

Luma/Chroma Swap 44h, Bit 7	
0	Table as above
1	Table above with all Luma/Chroma instances swapped

Table III. Output Configuration in HD/PS Only Mode

HD/PS Input Format	HD/PS RGB Input 15h, Bit 1	RGB/YPrPb Output 02h, Bit 5	HD/PS Color Swap 15h, Bit 3	DAC A	DAC B	DAC C	DAC D	DAC E	DAC F
YCrCb 4:2:2	0	0	0	N/A	N/A	N/A	G	B	R
YCrCb 4:2:2	0	0	1	N/A	N/A	N/A	G	R	B
YCrCb 4:2:2	0	1	0	N/A	N/A	N/A	Y	Pb	Pr
YCrCb 4:2:2	0	1	1	N/A	N/A	N/A	Y	Pr	Pb
YCrCb 4:4:4	0	0	0	N/A	N/A	N/A	G	B	R
YCrCb 4:4:4	0	0	1	N/A	N/A	N/A	G	R	B
YCrCb 4:4:4	0	1	0	N/A	N/A	N/A	Y	Pb	Pr
YCrCb 4:4:4	0	1	1	N/A	N/A	N/A	Y	Pr	Pb
RGB 4:4:4	1	0	0	N/A	N/A	N/A	G	B	R
RGB 4:4:4	1	0	1	N/A	N/A	N/A	G	R	B
RGB 4:4:4	1	1	0	N/A	N/A	N/A	G	B	R
RGB 4:4:4	1	1	1	N/A	N/A	N/A	G	R	B

Table IV. Output Configuration in Simultaneous SD and HD/PS Only Mode

Input Formats	RGB/YPrPb Output 02h, Bit 5	HD/PS Color Swap 15h, Bit 3	DAC A	DAC B	DAC C	DAC D	DAC E	DAC F
ITU-R.BT656 and HD YCrCb in 4:2:2	0	0	CVBS	Luma	Chroma	G	B	R
ITU-R.BT656 and HD YCrCb in 4:2:2	0	1	CVBS	Luma	Chroma	G	R	B
ITU-R.BT656 and HD YCrCb in 4:2:2	1	0	CVBS	Luma	Chroma	Y	Pb	Pr
ITU-R.BT656 and HD YCrCb in 4:2:2	1	1	CVBS	Luma	Chroma	Y	Pr	Pb

ADV7310/ADV7311

TIMING MODES

HD Async Timing Mode

[Subaddress 10h, Bit 3, 2]

For any input data that does not conform to the standards selectable in input mode, Subaddress 10h, asynchronous timing mode can be used to interface to the ADV7310/ADV7311. Timing control signals for $\overline{\text{HSYNC}}$, $\overline{\text{VSYNC}}$, and $\overline{\text{BLANK}}$ have to be programmed by the user. Macrovision and programmable oversampling rates are not available in async timing mode.

In async mode, the PLL must be turned off [Subaddress 00h, Bit 1 = 1].

Figures 29a and 29b show examples of how to program the ADV7310/ADV7311 to accept a different high definition standard other than SMPTE 293M, SMPTE 274M, SMPTE 296M, or ITU-R BT.1358.

The following truth table must be followed when programming the control signals in async timing mode. For standards that do not require a tri-sync level, $\overline{\text{P_BLANK}}$ must be tied low at all times.

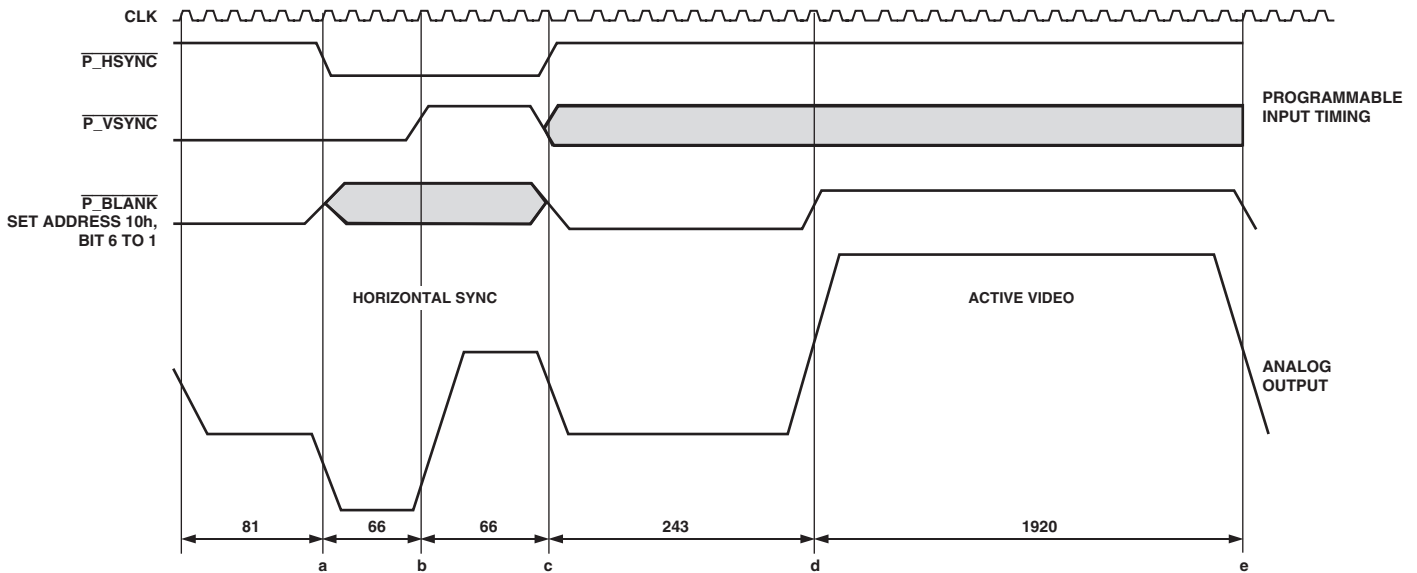

Figure 29a. Async Timing Mode—Programming Input Control Signals for SMPTE 295M Compatibility

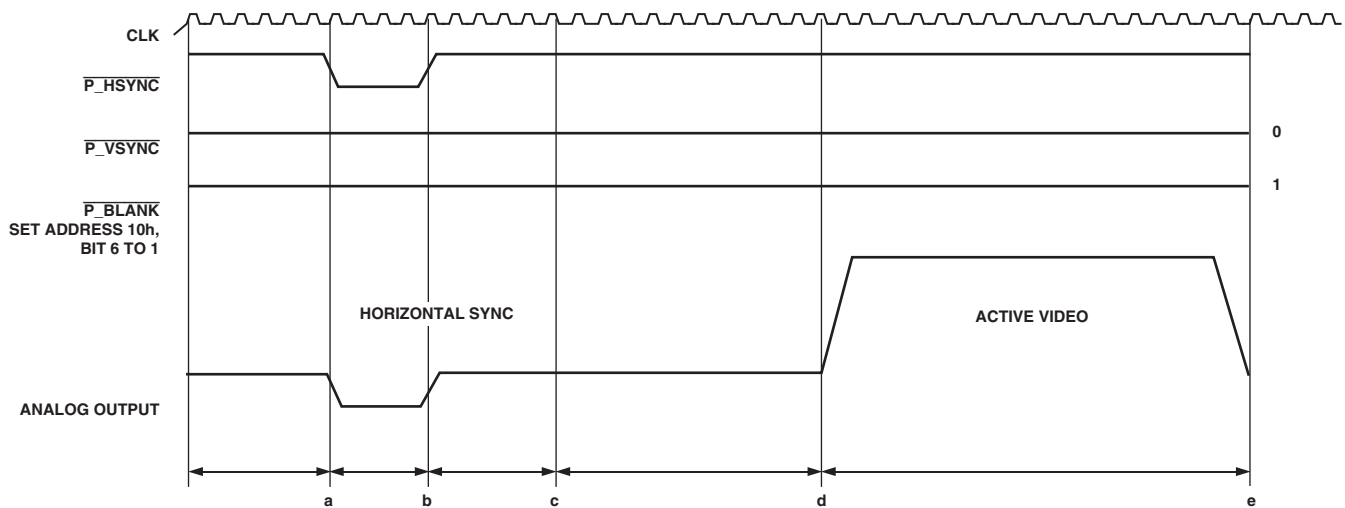

Figure 29b. Async Timing Mode—Programming Input Control Signals for Bilevel Sync Signal

Table V. Async Timing Mode Truth Table

$\overline{P_HSYNC}$	$\overline{P_VSYNC}$	$\overline{P_BLANK}^*$	Reference	Reference in Figure 29
1 → 0	0	0 or 1	50% point of falling edge of trilevel horizontal sync signal	a
0	0 → 1	0 or 1	25% point of rising edge of trilevel horizontal sync signal	b
0 → 1	0 or 1	0	50% point of falling edge of trilevel horizontal sync signal	c
1	0 or 1	0 → 1	50% start of active video	d
1	0 or 1	1 → 0	50% end of active video	e

*When async timing mode is enabled, $\overline{P_BLANK}$, Pin 25, becomes an active high input. $\overline{P_BLANK}$ is set to active low at Address 10h, Bit 6.

HD TIMING RESET

A timing reset is achieved by toggling the HD timing reset control bit [Subaddress 14h, Bit 0] from 0 to 1. In this state the horizontal and vertical counters will remain reset. When this bit is set back to 0, the internal counters will commence counting again.

The minimum time the pin has to be held high is one clock cycle; otherwise, this reset signal might not be recognized. This timing reset applies to the HD timing counters only.

ADV7310/ADV7311

SD Real-Time Control, Subcarrier Reset, and Timing Reset [Subaddress 44h, Bit 2, 1]

Together with the RTC_SCR_TR pin and SD Mode Register 3 [Address 44h, Bit 1, 2], the ADV7310/ADV7311 can be used in (a) timing reset mode, (b) subcarrier phase reset mode, or (c) RTC mode.

a. A timing reset is achieved in a low-to-high transition on the RTC_SCR_TR pin (Pin 31). In this state, the horizontal and vertical counters will remain reset. On releasing this pin (set to low), the internal counters will commence counting again, the field count will start on Field 1, and the subcarrier phase will be reset.

The minimum time the pin has to be held high is one clock cycle; otherwise, this reset signal might not be recognized. This timing reset applies to the SD timing counters only.

b. In subcarrier phase reset, a low-to-high transition on the RTC_SCR_TR pin (Pin 31) will reset the subcarrier phase to zero on the field following the subcarrier phase reset when the SD RTC/TR/SCR control bits at Address 44h are set to 01.

This reset signal will have to be held high for a minimum of one clock cycle.

Since the field counter is not reset, it is recommended that the reset signal be applied in Field 7 [PAL] or Field 3 [NTSC]. The reset of the phase will then occur on the next field, i.e., Field 1, being lined up correctly with the internal counters. The field count register at Address 7Bh can be used to identify the number of the active field.

c. In RTC mode, the ADV7310/ADV7311 can be used to lock to an external video source. The real-time control mode allows the ADV7310/ADV7311 to automatically alter the subcarrier frequency to compensate for line length variations. When the part is connected to a device that outputs a digital data stream in the RTC format, such as an ADV7183A video decoder (see Figure 32), the part will automatically change to the compensated subcarrier frequency on a line by line basis. This digital data stream is 67 bits wide and the subcarrier is contained in Bits 0 to 21. Each bit is two clock cycles long. 00h should be written into all four subcarrier frequency registers when this mode is used.

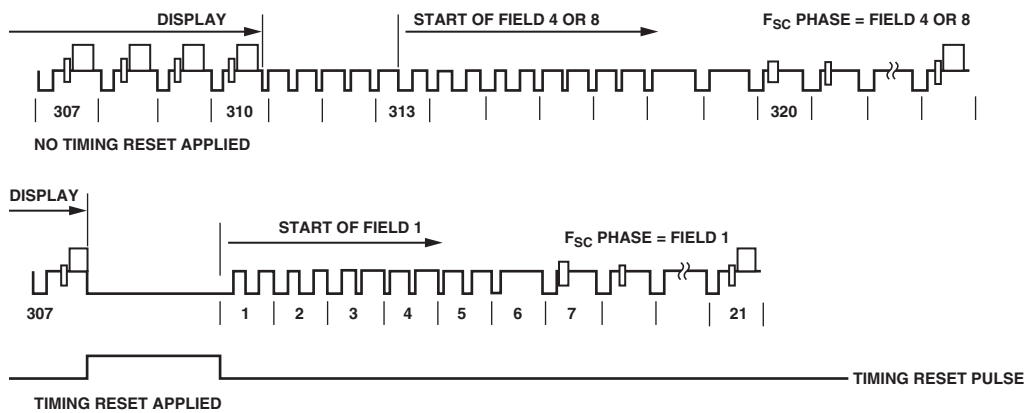

Figure 30. Timing Reset Timing Diagram

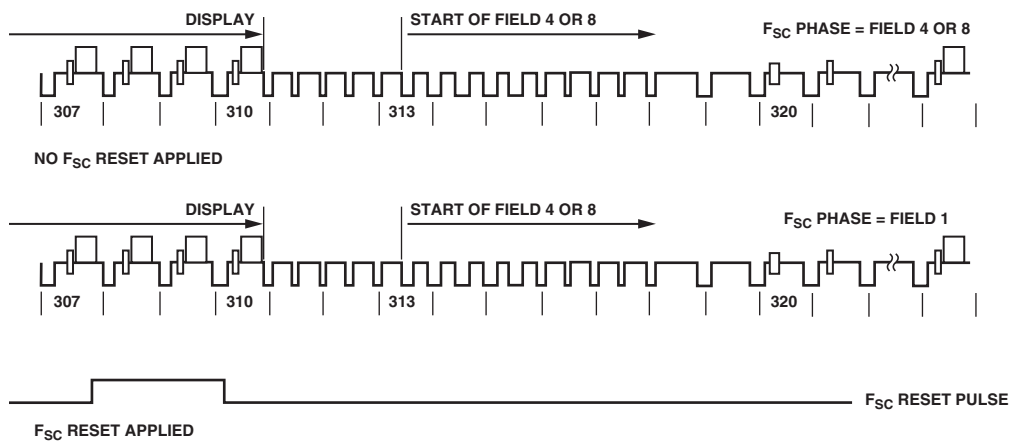

Figure 31. Subcarrier Reset Timing Diagram

Reset Sequence

A reset is activated with a high-to-low transition on the $\overline{\text{RESET}}$ pin [Pin 33] according to the timing specifications. The ADV7310/ADV7311 will revert to the default output configuration.

Figure 32 illustrates the $\overline{\text{RESET}}$ sequence timing.

SD VCR FF/RW Sync [Subaddress 42h, Bit 5]

In DVD record applications where the encoder is used with a decoder, the VCR FF/RW sync control bit can be used for non-standard input video, i.e., in fast forward or rewind modes.

In fast forward mode, the sync information at the start of a new field in the incoming video usually occurs before the correct number of lines/fields are reached; in rewind mode, this sync signal usually occurs after the total number of lines/fields are reached. Conventionally this means that the output video will have corrupted field signals, one generated by the incoming video and one generated when the internal lines/field counters reach the end of a field.

When the VCR FF/RW sync control is enabled [Subaddress 42h Bit 5] the lines/field counters are updated according to the incoming $\overline{\text{VSYNC}}$ signal and the analog output matches the incoming $\overline{\text{VSYNC}}$ signal.

This control is available in all slave timing modes except Slave Mode 0.

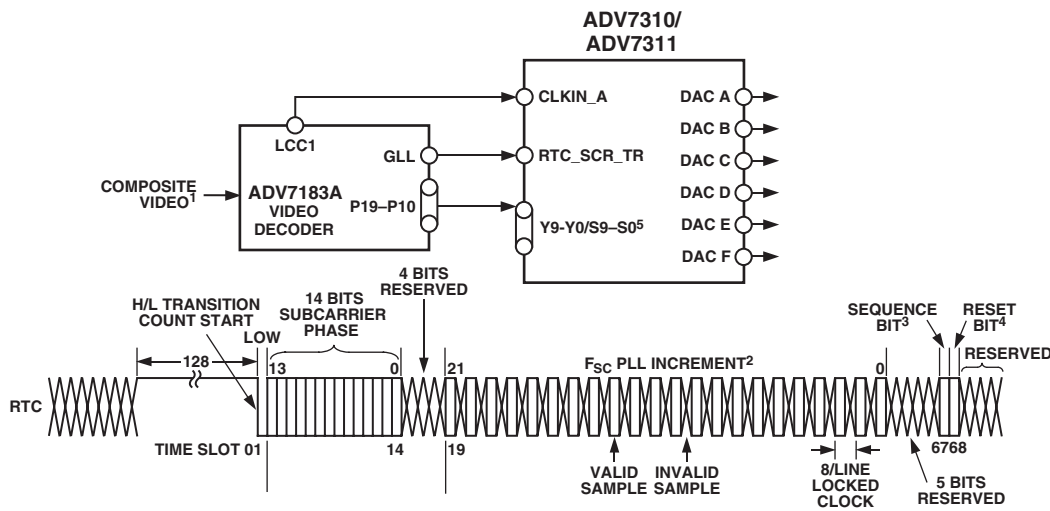

NOTES

- ¹i.e., VCR OR CABLE
- ²F_{SC} PLL INCREMENT IS 22 BITS LONG. VALUE LOADED INTO ADV7310/ADV7311 F_{SC} DDS REGISTER IS F_{SC} PLL INCREMENTS BITS 21:0 PLUS BITS 0:9 OF SUBCARRIER FREQUENCY REGISTERS. ALL ZEROS SHOULD BE WRITTEN TO THE SUBCARRIER FREQUENCY REGISTERS OF THE ADV7310/ADV7311.
- ³SEQUENCE BIT
PAL: 0 = LINE NORMAL, 1 = LINE INVERTED
NTSC: 0 = NO CHANGE
- ⁴RESET ADV7310/ADV7311 DDS
- ⁵SELECTED BY REGISTER ADDRESS 0x01 BIT 7

Figure 32. RTC Timing and Connections

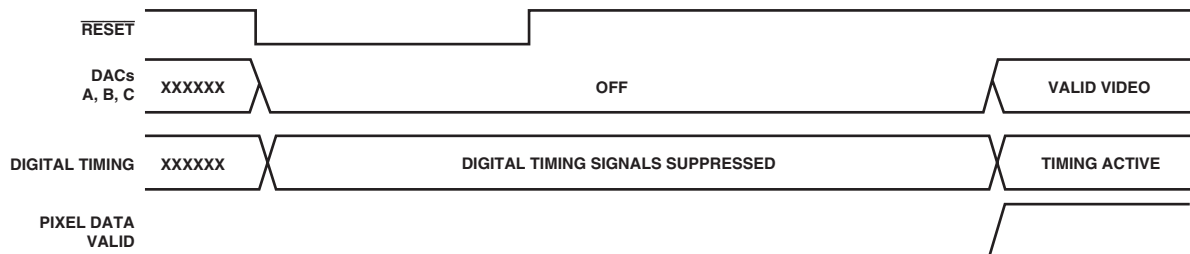

Figure 33. $\overline{\text{RESET}}$ Timing Sequence

ADV7310/ADV7311

Vertical Blanking Interval

The ADV7310/ADV7311 accept input data that contains VBI data [CGMS, WSS, VITS, and so on] in SD and HD modes.

For SMPTE 293M [525p] standards, VBI data can be inserted on Lines 13 to 42 of each frame, or on Lines 6 to 43 for the ITU-R BT.1358 [625p] standard.

For SD NTSC this data can be present on Lines 10 to 20, and in PAL on Lines 7 to 22.

If VBI is disabled [Address 11h, Bit 4 for HD; Address 43h, Bit 4 for SD], VBI data is not present at the output and the entire VBI is blanked. These control bits are valid in all master and slave modes.

In Slave Mode 0, if VBI is enabled, the blanking bit in the EAV/SAV code is overwritten, and it is possible to use VBI in this timing mode as well.

In Slave Mode 1 or 2, the $\overline{\text{BLANK}}$ control bit must be set to enabled [Address 4Ah, Bit 3] to allow VBI data to pass through the ADV7310/ADV7311. Otherwise, the ADV7310/ADV7311 automatically blanks the VBI to standard.

If CGMS is enabled and VBI is disabled, the CGMS data will nevertheless be available at the output.

Subcarrier Frequency Registers

[Subaddress 4Ch-4Fh]

Four 8-bit registers are used to set up the subcarrier frequency. The value of these registers is calculated using the equation

$$\text{Subcarrier Frequency Register} = \frac{\text{Number of subcarrier frequency values in one video line}}{\text{Number of 27 MHz clk cycles in one video line}} \times 2^{23}$$

*Rounded to the nearest integer

For example, in NTSC mode,

$$\text{Subcarrier Frequency Value} = \left(\frac{227.5}{1716} \right) \times 2^{23} = 569408542$$

Subcarrier Register Value = 21F07C1Eh

SD F_{SC} Register 0: 1Eh

SD F_{SC} Register 1: 7Ch

SD F_{SC} Register 2: F0h

SD F_{SC} Register 3: 21h

Refer to the MPU Port Description section for more details on how to access the subcarrier frequency registers.

Square Pixel Timing

[Register 42h, Bit 4]

In square pixel mode, the following timing diagrams apply.

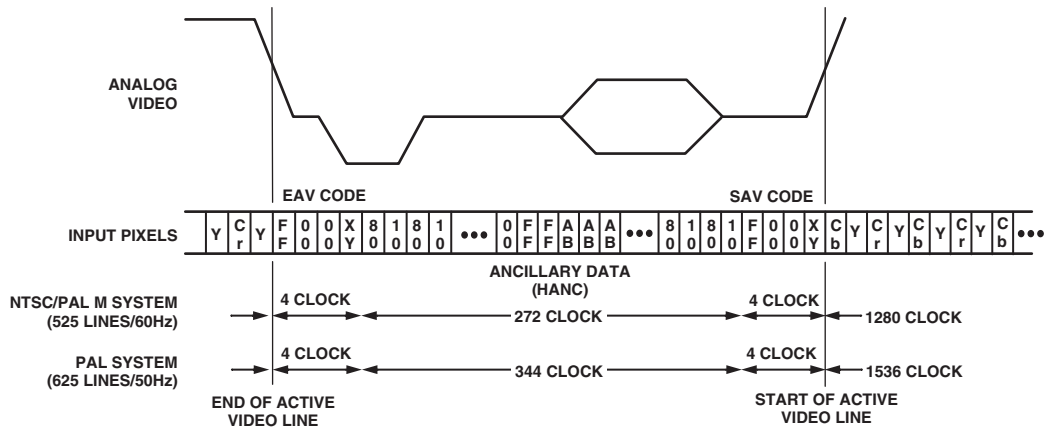

Figure 34. EAV/SAV Embedded Timing

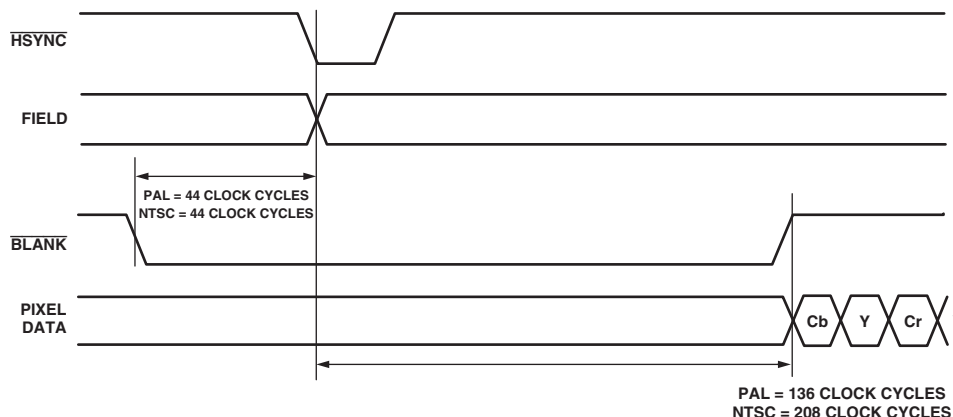

Figure 35. Active Pixel Timing

FILTER SECTION

Table VI shows an overview of the programmable filters available on the ADV7310/ADV7311.

Table VI. Selectable Filters

Filter	Subaddress
SD Luma LPF NTSC	40h
SD Luma LPF PAL	40h
SD Luma Notch NTSC	40h
SD Luma Notch PAL	40h
SD Luma SSAF	40h
SD Luma CIF	40h
SD Luma QCIF	40h
SD Chroma 0.65 MHz	40h
SD Chroma 1.0 MHz	40h
SD Chroma 1.3 MHz	40h
SD Chroma 2.0 MHz	40h
SD Chroma 3.0 MHz	40h
SD Chroma CIF	40h
SD Chroma QCIF	40h
SD UV SSAF	42h
HD Chroma Input	13h
HD Sinc Filter	13h
HD Chroma SSAF	13h

HD Sinc Filter

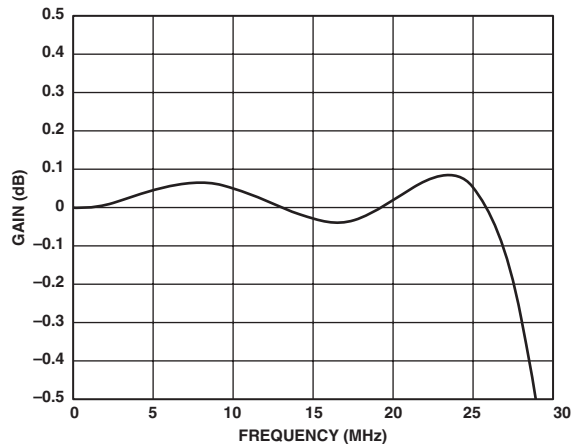

Figure 36. HD Sinc Filter Enabled

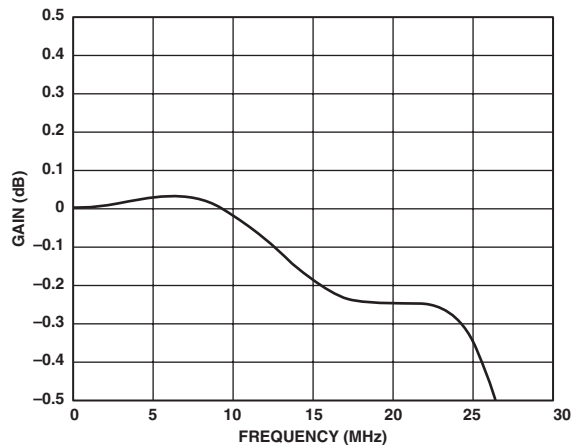

Figure 37. HD Sinc Filter Disabled

ADV7310/ADV7311

SD Internal Filter Response

[Subaddress 40h; Subaddress 42, Bit 0]

The Y filter supports several different frequency responses including two low-pass responses, two notch responses, an extended (SSAF) response with or without gain boost attenuation, a CIF response, and a QCIF response. The UV filter supports several different frequency responses including six low-pass responses, a CIF response, and a QCIF response, as can be seen in the figures on the following pages.

If SD SSAF gain is enabled, there is the option of 12 responses in the range from -4 dB to +4 dB [Subaddress 47, Bit 4]. The desired response can be chosen by the user by programming the correct value via the I²C [Subaddress 62h]. The variation of frequency responses can be seen in the figures on the following pages.

In addition to the chroma filters listed in Table VII, the ADV7310/ADV7311 contains an SSAF filter specifically designed for and applicable to the color difference component outputs, U and V. This filter has a cutoff frequency of about 2.7 MHz and -40 dB at 3.8 MHz, as can be seen in Figure 38. This filter can be controlled with Address 42h, Bit 0.

If this filter is disabled, the selectable chroma filters shown in Table VII can be used for the CVBS or Luma/Chroma signal.

Table VII. Internal Filter Specifications

Filter	Pass-Band Ripple ¹ (dB)	3 dB Bandwidth ² (MHz)
Luma LPF NTSC	0.16	4.24
Luma LPF PAL	0.1	4.81
Luma Notch NTSC	0.09	2.3/4.9/6.6
Luma Notch PAL	0.1	3.1/5.6/6.4
Luma SSAF	0.04	6.45
Luma CIF	0.127	3.02
Luma QCIF	Monotonic	1.5
Chroma 0.65 MHz	Monotonic	0.65
Chroma 1.0 MHz	Monotonic	1
Chroma 1.3 MHz	0.09	1.395
Chroma 2.0 MHz	0.048	2.2
Chroma 3.0 MHz	Monotonic	3.2
Chroma CIF	Monotonic	0.65
Chroma QCIF	Monotonic	0.5

NOTES

¹Pass-band ripple is the maximum fluctuation from the 0 dB response in the pass band, measured in dB. The pass band is defined to have 0 Hz to f_c (Hz) frequency limits for a low-pass filter, 0 Hz to f_1 (Hz) and f_2 (Hz) to infinity for a notch filter, where f_c , f_1 , and f_2 are the -3 dB points.

²3 dB bandwidth refers to the -3 dB cutoff frequency.

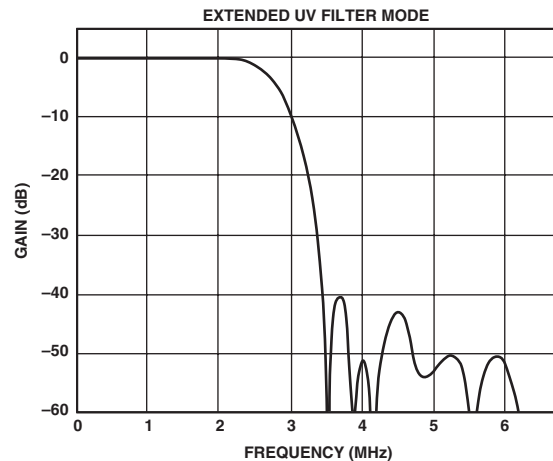
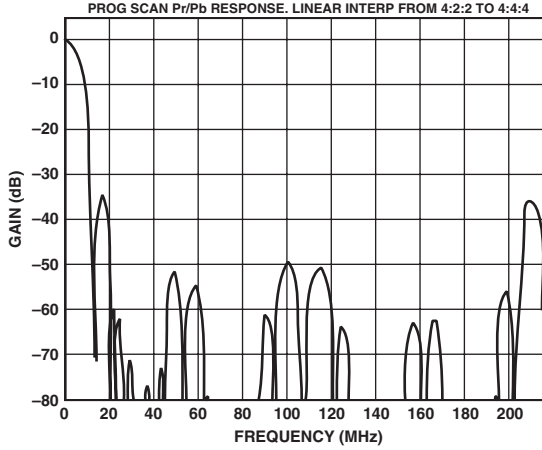
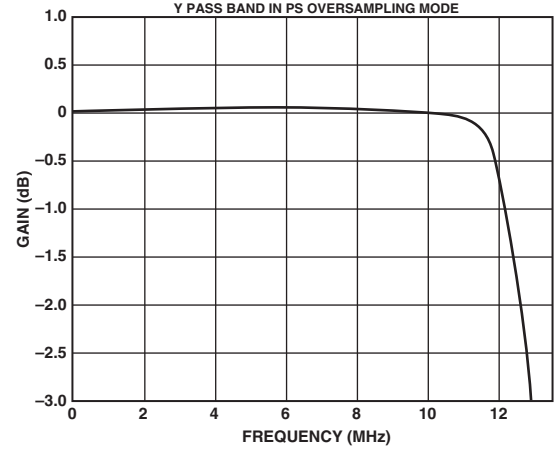

Figure 38. UV SSAF Filter

Typical Performance Characteristics—ADV7310/ADV7311



TPC 1. PS—UV 8× Oversampling Filter (Linear)



TPC 4. PS—Y 8× Oversampling Filter (Pass Band)

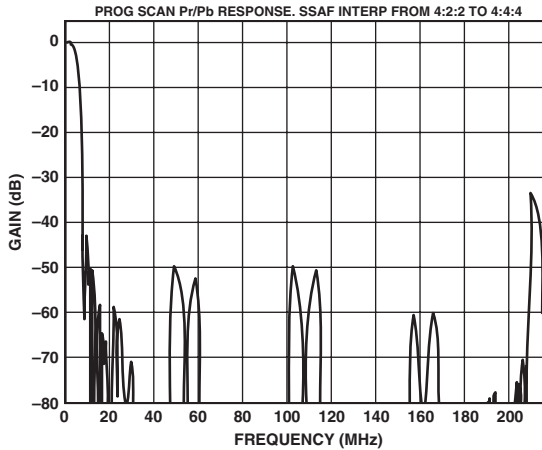

TPC 2. PS—UV 8× Oversampling Filter (SSAF)

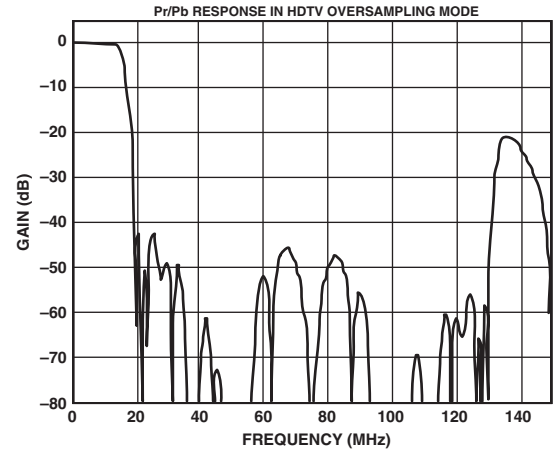

TPC 5. HDTV—UV (2× Oversampling Filter)

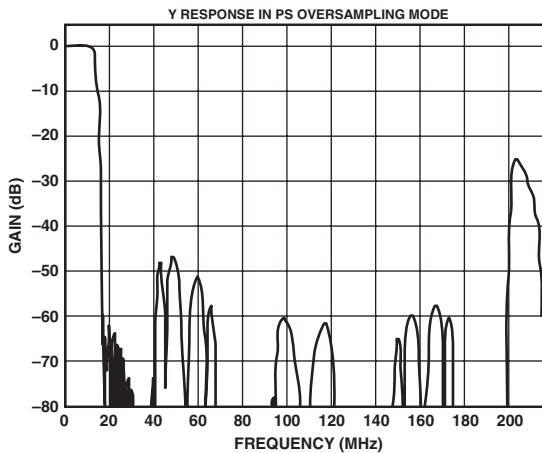

TPC 3. PS—Y (8× Oversampling Filter)

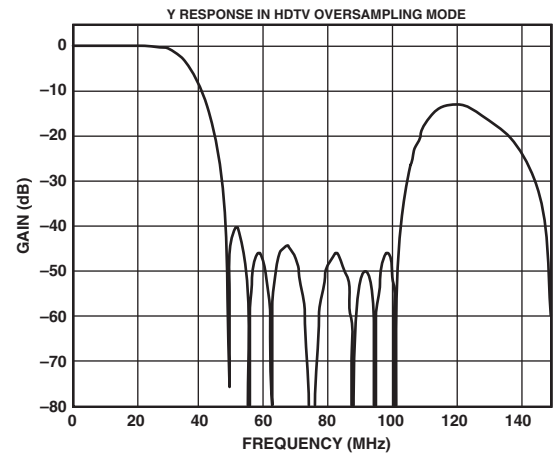

TPC 6. HDTV—Y (2× Oversampling Filter)

ADV7310/ADV7311

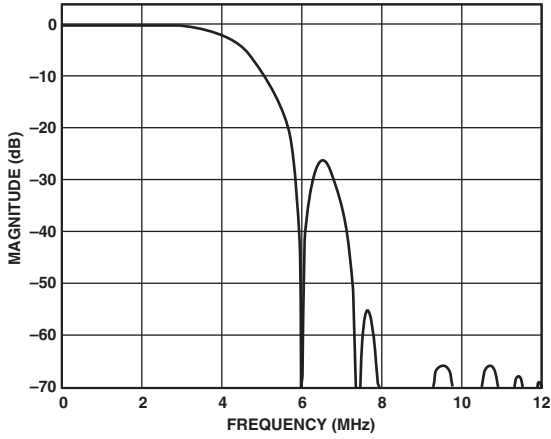

TPC 7. Luma NTSC Low-Pass Filter

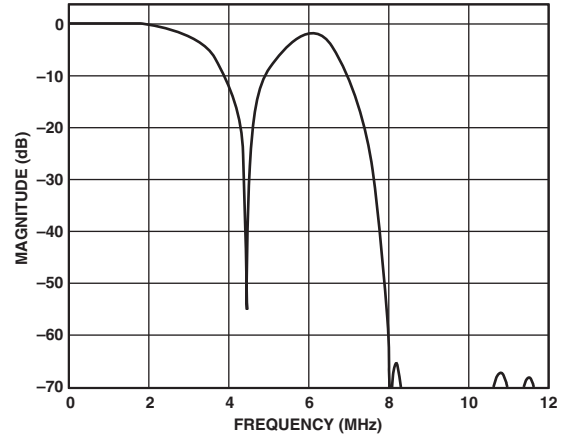

TPC 10. Luma PAL Notch Filter

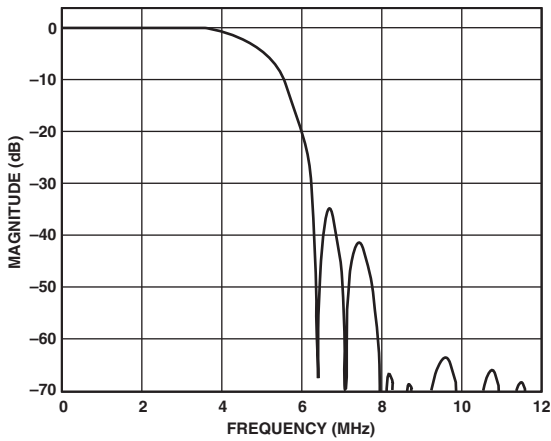

TPC 8. Luma PAL Low-Pass Filter

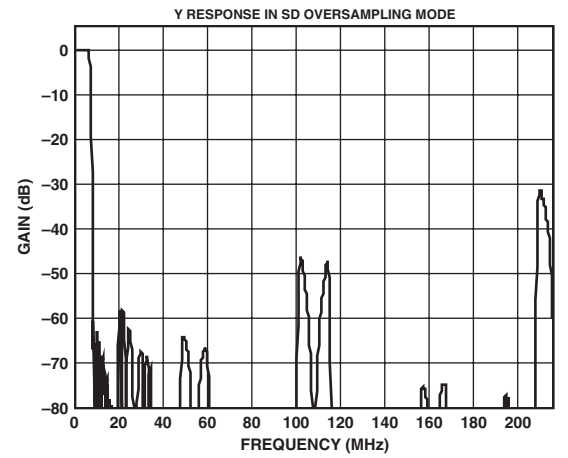

TPC 11. Y-16x Oversampling Filter

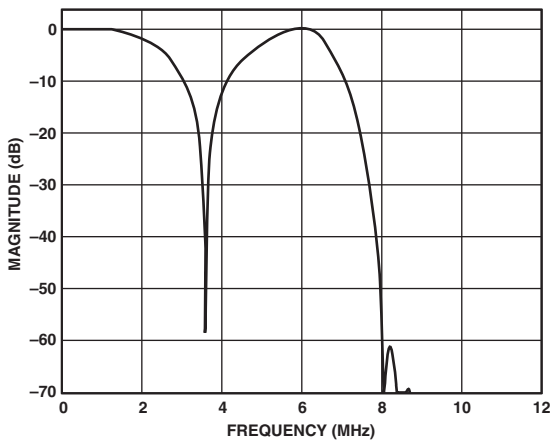

TPC 9. Luma NTSC Notch Filter

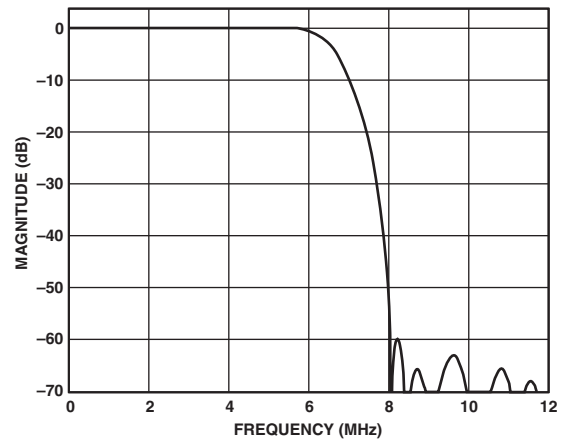

TPC 12. Luma SSAF Filter up to 12 MHz

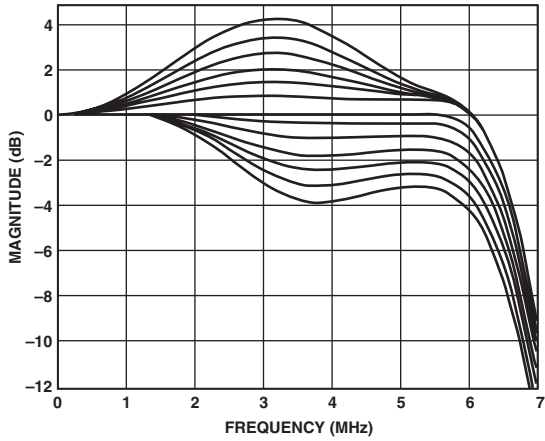

TPC 13. Luma SSAF Filter—Programmable Responses

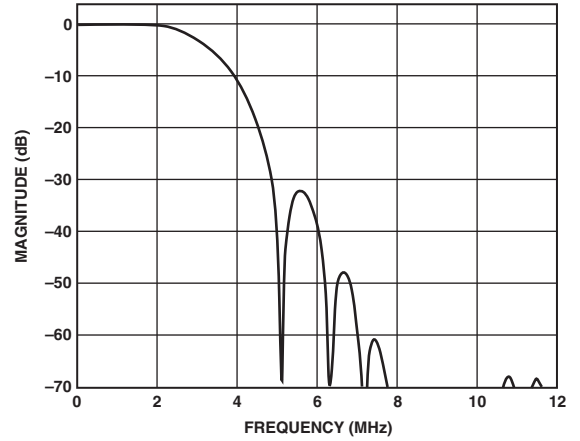

TPC 16. Luma CIF Low-Pass Filter

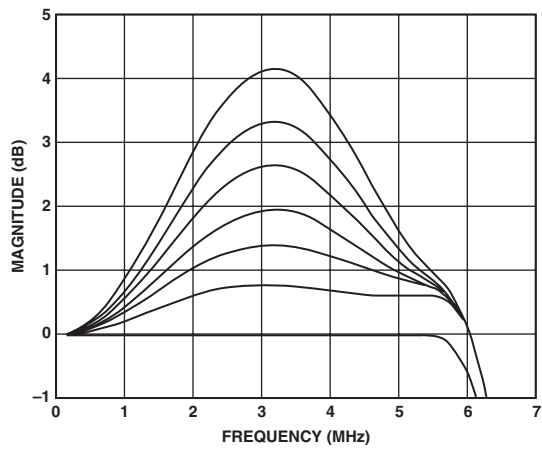

TPC 14. Luma SSAF Filter—Programmable Gain

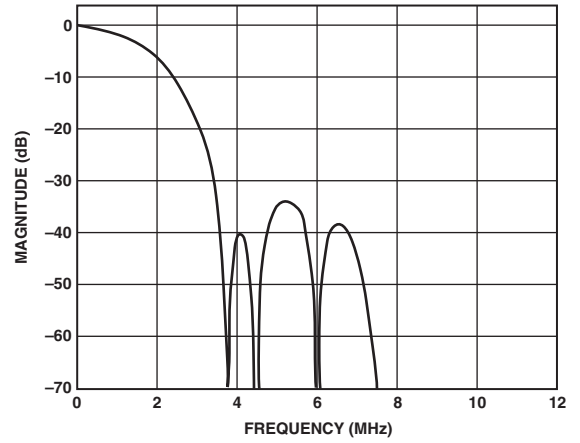

TPC 17. Luma QCIF Low-Pass Filter

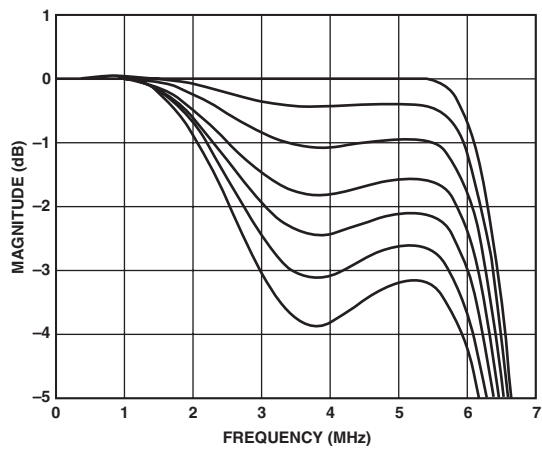

TPC 15. Luma SSAF Filter—Programmable Attenuation

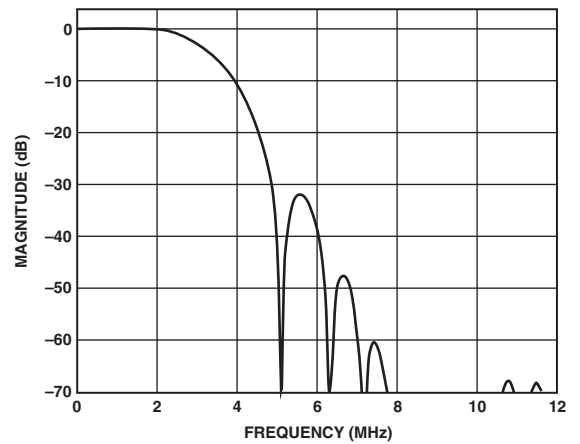

TPC 18. Chroma 3.0 MHz Low-Pass Filter

ADV7310/ADV7311

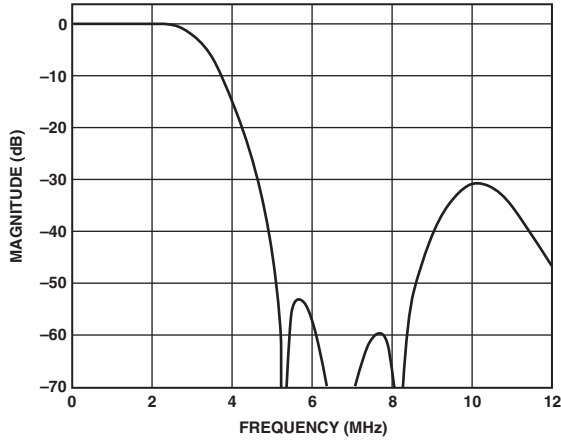

TPC 19. Chroma 2.0 MHz Low-Pass Filter

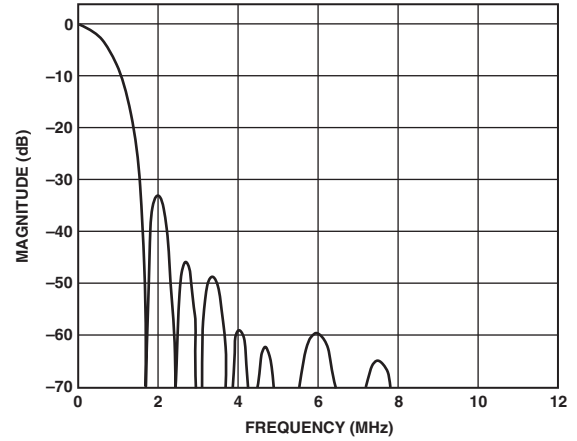

TPC 22. Chroma 0.65 MHz Low-Pass Filter

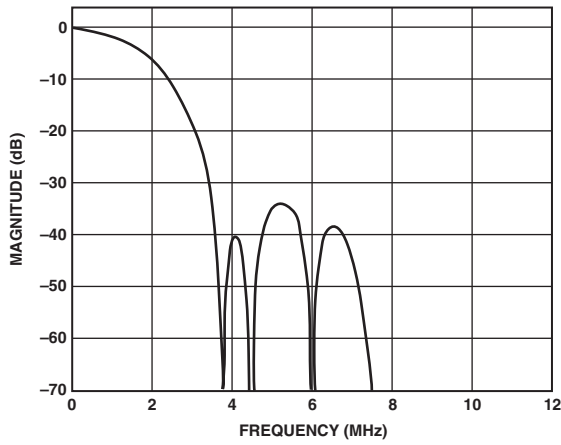

TPC 20. Chroma 1.3 MHz Low-Pass Filter

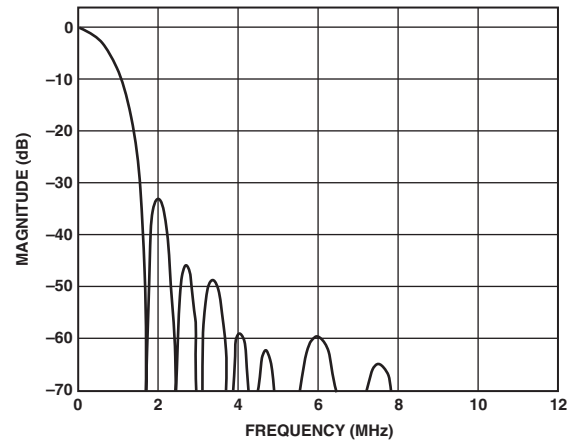

TPC 23. Chroma CIF Low-Pass Filter

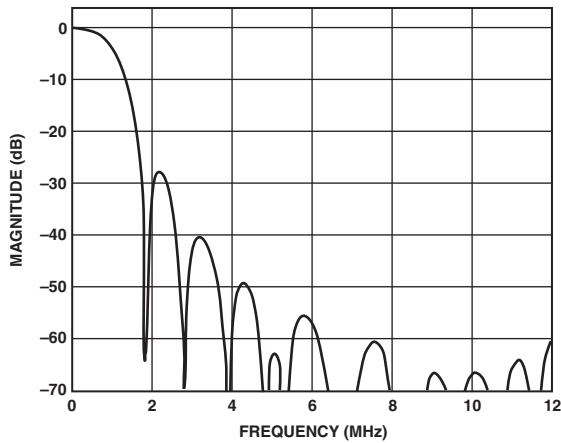

TPC 21. Chroma 1.0 MHz Low-Pass Filter

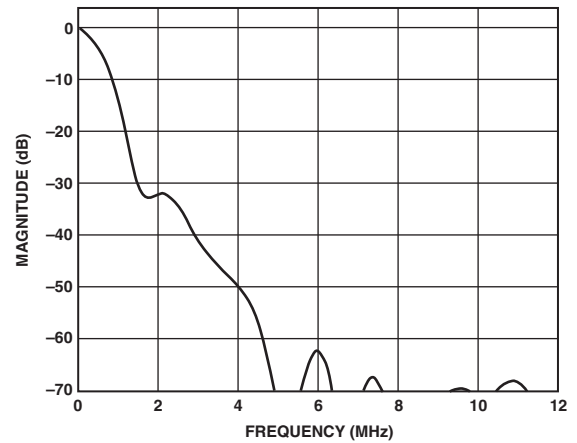

TPC 24. Chroma QCIF Low-Pass Filter

COLOR CONTROLS AND RGB MATRIX

HD Y Level, HD Cr Level, HD Cb Level

[Subaddress 16h–18h]

Three 8-bit registers at Address 16h, 17h, 18h are used to program the output color of the internal HD test pattern generator, be it the lines of the cross hatch pattern or the uniform field test pattern. They are not functional as color controls on external pixel data input. For this purpose the RGB matrix is used.

The standard used for the values for Y and the color difference signals to obtain white, black, and the saturated primary and complementary colors conforms to the ITU-R BT.601-4 standard.

Table VIII shows sample color values to be programmed into the color registers when Output Standard Selection is set to EIA 770.2.

Table VIII. Sample Color Values for EIA 770.2 Output Standard Selection

Sample Color	Y Value	Cr Value	Cb Value
White	235 (EB)	128 (80)	128 (80)
Black	16 (10)	128 (80)	128 (80)
Red	81 (51)	240 (F0)	90 (5A)
Green	145 (91)	34 (22)	54 (36)
Blue	41 (29)	110 (6E)	240 (F0)
Yellow	210 (D2)	146 (92)	16 (10)
Cyan	170 (AA)	16 (10)	166 (A6)
Magenta	106 (6A)	222 (DE)	202 (CA)

HD RGB Matrix

[Subaddress 03h–09h]

When the programmable RGB matrix is disabled [Address 02h, Bit 3], the internal RGB matrix takes care of all YCrCb to YUV or RGB scaling according to the input standard programmed into the device.

When the programmable RGB matrix is enabled, the color components are converted according to the 1080i standard [SMPTE 274M]:

$$Y' = 0.2126R' + 0.7152G' + 0.0722B'$$

$$CB' = [0.5 / (1 - 0.0722)](B' - Y')$$

$$CR' = [0.5 / (1 - 0.2126)](R' - Y')$$

This is reflected in the preprogrammed values for GY = 138Bh, GU = 93h, GV = 3B, BU = 248h, and RV = 1F0.

If another input standard is used, the scale values for GY, GU, GV, BU, and RV have to be adjusted according to this input standard. The user must consider the fact that the color component conversion might use different scale values. For example, SMPTE 293M uses the following conversion:

$$Y' = 0.299R' + 0.587G' + 0.114B'$$

$$CB' = [0.5 / (1 - 0.114)](B' - Y')$$

$$CR' = [0.5 / (1 - 0.299)](R' - Y')$$

The programmable RGB matrix can be used to control the HD output levels in cases where the video output does not conform to standard due to altering the DAC output stages such as termination resistors. The programmable RGB matrix is used for external HD data and is not functional when the HD test pattern is enabled.

Programming the RGB Matrix

The RGB matrix should be enabled [Address 02h, Bit 3], the output should be set to RGB [Address 02h, Bit 5], sync on PrPb should be disabled [Address 15h, Bit 2], and sync on RGB is optional [Address 02h, Bit 4].

GY at address 03h and 05h control the output levels on the green signal, BU at 04h and 08h the blue signal output levels and RV at 04h and 09h the red output levels. To control YPrPb output levels, YUV output should be enabled [Address 02h, Bit 5]. In this case GY [Address 05h; Address 03, Bit 0-1] is used for the Y output, RV [Address 09; Address 04, Bit 0-1] is used for the Pr output, and BU [Address 08h; Address 04h, Bit 2-3] is used for the Pb output.

If RGB output is selected the RGB matrix scaler uses the following equations:

$$G = GY \times Y + GU \times Pb + GV \times Pr$$

$$B = GY \times Y + BU \times Pb$$

$$R = GY \times Y + RV \times Pr$$

If YPrPb output is selected the following equations are used:

$$Y = GY \times Y$$

$$U = BU \times Pb$$

$$V = RV \times Pr$$

On power-up, the RGB matrix is programmed with the default values below.

Table IX. RGB Matrix Default Values

Address	Default
03h	03h
04h	F0h
05h	4Eh
06h	0Eh
07h	24h
08h	92h
09h	7Ch

When the programmable RGB matrix is not enabled, the ADV7310/ADV7311 automatically scales YCrCb inputs to all standards supported by this part.

SD Luma and Color Control

[Subaddress 5Ch, 5Dh, 5Eh, 5Fh]

SD Y Scale, SD Cr Scale, and SD Cb Scale are three 10-bit wide control registers to scale the Y, U, and V output levels.

Each of these registers represents the value required to scale the U or V level from 0.0 to 2.0 and the Y level from 0.0 to 1.5 of its initial level. The value of these 10 bits is calculated using the following equation:

$$Y, U, \text{ or } V \text{ Scalar Value} = \text{Scale Factor} \times 512$$

For example:

$$\text{Scale Factor} = 1.18$$

$$Y, U, \text{ or } V \text{ Scale Value} = 1.18 \times 512 = 665.6$$

$$Y, U, \text{ or } V \text{ Scale Value} = 665 \text{ (rounded to the nearest integer)}$$

$$Y, U, \text{ or } V \text{ Scale Value} = 1010 \ 0110 \ 01b$$

Address 5Ch, SD LSB Register = 15h

Address 5Dh, SD Y Scale Register = A6h

Address 5Eh, SD V Scale Register = A6h

Address 5Fh, SD U Scale Register = A6h

ADV7310/ADV7311

SD Hue Adjust Value

[Subaddress 60h]

The hue adjust value is used to adjust the hue on the composite and chroma outputs.

These eight bits represent the value required to vary the hue of the video data, i.e., the variance in phase of the subcarrier during active video with respect to the phase of the subcarrier during the color burst. The ADV7310/ADV7311 provides a range of $\pm 22.5^\circ$ increments of 0.17578125° . For normal operation (zero adjustment), this register is set to 80h. FFh and 00h represent the upper and lower limits (respectively) of adjustment attainable.

(Hue Adjust) [°] = $0.17578125^\circ \times (\text{HCR}_d - 128)$, for positive hue adjust value.

For example, to adjust the hue by $+4^\circ$, write 97h to the Hue Adjust Value register:

$$\left(\frac{4}{0.17578125} \right) + 128 = 105d^* = 97h$$

*rounded to the nearest integer

To adjust the hue by -4° , write 69h to the Hue Adjust Value register:

$$\left(\frac{-4}{0.17578125} \right) + 128 = 105d^* = 69h$$

*rounded to the nearest integer

SD Brightness Control

[Subaddress 61h]

The brightness is controlled by adding a programmable setup level onto the scaled Y data. This brightness level may be added onto the scaled Y data. For NTSC with pedestal, the setup can vary from 0IRE to 22.5IRE. For NTSC without pedestal and PAL, the setup can vary from -7.5IRE to +15IRE.

The brightness control register is an 8-bit register. Seven bits of this 8-bit register are used to control the brightness level. This brightness level can be a positive or negative value.

For example:

Standard: NTSC with Pedestal.

To add +20IRE brightness level, write 28h to Address 61h, SD brightness.

$$\begin{aligned} [SD\text{BrightnessValue}]_h &= \\ [IRE\text{Value} \times 2.015631]_h &= \\ [20 \times 2.015631]_h &= [40.31262]_h = 28h \end{aligned}$$

Standard: PAL.

To add -7IRE brightness level, write 72h to Address 61h, SD brightness.

$$\begin{aligned} [IRE\text{Value} \times 2.015631] &= \\ [7 \times 2.015631] &= [14.109417] = 0001110b \\ [0001110] \text{ into twos complement} &= [1110010]_b = 72h \end{aligned}$$

Table X. Brightness Control Values*

Setup Level In NTSC with Pedestal	Setup Level In NTSC No Pedestal	Setup Level In PAL	SD Brightness
22.5 IRE	15 IRE	15 IRE	1Eh
15 IRE	7.5 IRE	7.5 IRE	0Fh
7.5 IRE	0 IRE	0 IRE	00h
0 IRE	-7.5 IRE	-7.5 IRE	71h

*Values in the range from 3Fh to 44h might result in an invalid output signal.

SD Brightness Detect

[Subaddress 7Ah]

The ADV7310/ADV7311 allow monitoring of the brightness level of the incoming video data. Brightness detect is a read-only register.

Double Buffering

[Subaddress 13h, Bit 7; Subaddress 48h, Bit 2]

Double buffered registers are updated once per field on the falling edge of the $\overline{\text{VSYNC}}$ signal. Double buffering improves the overall performance since modifications to register settings will not be made during active video, but take effect on the start of the active video.

Double buffering can be activated on the following HD registers: HD Gamma A and Gamma B curves and HD CGMS registers.

Double buffering can be activated on the following SD registers: SD Gamma A and Gamma B curves, SD Y Scale, SD U Scale, SD V Scale, SD Brightness, SD Closed Captioning, and SD Macrovision Bits 5-0.

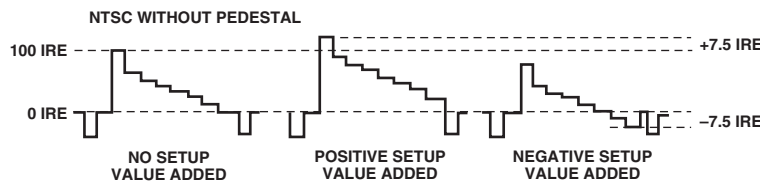

Figure 39. Examples of Brightness Control Values

PROGRAMMABLE DAC GAIN CONTROL

DACs A, B, and C are controlled by REG 0A.

DACs D, E, and F are controlled by REG 0B.

The I²C control registers will adjust the output signal gain up or down from its absolute level.

CASE A

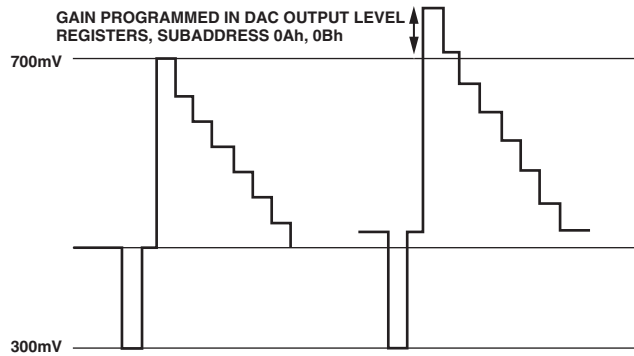

CASE B

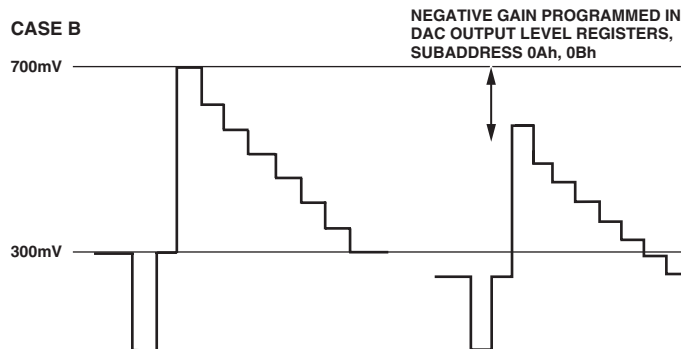

Figure 40. Programmable DAC Gain—Positive and Negative Gain

In case A, the video output signal is gained. The absolute level of the sync tip and blanking level both increase with respect to the reference video output signal. The overall gain of the signal is increased from the reference signal.

In case B, the video output signal is reduced. The absolute level of the sync tip and blanking level both decrease with respect to the reference video output signal. The overall gain of the signal is reduced from the reference signal.

The range of this feature is specified for $\pm 7.5\%$ of the nominal output from the DACs. For example, if the output current of the DAC is 4.33 mA, the DAC tune feature can change this output current from 4.008 mA (-7.5%) to 4.658 mA ($+7.5\%$).

The reset value of the vid_out_ctrl registers is 00h \rightarrow nominal DAC output current. The following table is an example of how the output current of the DACs varies for a nominal 4.33 mA output current.

Table XI.

Reg 0Ah or 0Bh	DAC Current (mA)	% Gain	
0100 0000 (40h)	4.658	7.5000%	(I ² C Reset Value, Nominal)
0011 1111 (3Fh)	4.653	7.3820%	
0011 1110 (3Eh)	4.648	7.3640%	
...	
...	
0000 0010 (02h)	4.43	0.0360%	
0000 0001 (01h)	4.38	0.0180%	
0000 0000 (00h)	4.33	0.0000%	
...	
...	
1111 1111 (FFh)	4.25	-0.0180%	
1111 1110 (FEh)	4.23	-0.0360%	
...	
...	
1100 0010 (C2h)	4.018	-7.3640%	
1100 0001 (C1h)	4.013	-7.3820%	
1100 0000 (C0h)	4.008	-7.5000%	

ADV7310/ADV7311

Gamma Correction

[Subaddress 24h–37h for HD, Subaddress 66h–79h for SD]

Gamma correction is available for SD and HD video. For each standard, there are twenty 8-bit wide registers. They are used to program the gamma correction curves A and B. HD gamma curve A is programmed at Addresses 24h to 2Dh, HD gamma curve B at 2Eh to 7h. SD gamma curve A is programmed at Addresses 66h to 6Fh, and SD gamma curve B at Addresses 70h to 79h.

Generally gamma correction is applied to compensate for the nonlinear relationship between signal input and brightness level output (as perceived on the CRT). It can also be applied wherever nonlinear processing is used.

Gamma correction uses the function

$$Signal_{OUT} = (Signal_{IN})^\gamma$$

where γ = gamma power factor.

Gamma correction is performed on the luma data only. The user may choose either of two different curves, curve A or curve B. At any one time, only one of these curves can be used.

The response of the curve is programmed at 10 predefined locations. In changing the values at these locations, the gamma curve can be modified. Between these points, linear interpolation is used to generate intermediate values. Considering the curve to have a total length of 256 points, the 10 locations are at 24, 32, 48, 64, 80, 96, 128, 160, 192, and 224. Locations 0, 16, 240, and 255 are fixed and cannot be changed.

For the length of 16 to 240, the gamma correction curve has to be calculated as follows:

$$y = x^\gamma$$

where:

- y = gamma corrected output
- x = linear input signal
- γ = gamma power factor

To program the gamma correction registers, the seven values for y have to be calculated using the following formula:

$$y_n = \left[\frac{x_{(n-16)}}{(240-16)} \right]^\gamma \times (240-16) + 16$$

where:

$x_{(n-16)}$ = Value for x along x axis at points

n = 24, 32, 48, 64, 80, 96, 128, 160, 192, or 224

y_n = Value for y along the y axis, which has to be written into the gamma correction register

For example:

$$\begin{aligned} y_{24} &= [(8 / 224)^{0.5} \times 224] + 16 = 58^* \\ y_{32} &= [(16 / 224)^{0.5} \times 224] + 16 = 76^* \\ y_{48} &= [(32 / 224)^{0.5} \times 224] + 16 = 101^* \\ y_{64} &= [(48 / 224)^{0.5} \times 224] + 16 = 120^* \\ y_{80} &= [(64 / 224)^{0.5} \times 224] + 16 = 136^* \\ y_{96} &= [(80 / 224)^{0.5} \times 224] + 16 = 150^* \\ y_{128} &= [(112 / 224)^{0.5} \times 224] + 16 = 174^* \\ y_{160} &= [(144 / 224)^{0.5} \times 224] + 16 = 195^* \\ y_{192} &= [(176 / 224)^{0.5} \times 224] + 16 = 214^* \\ y_{224} &= [(208 / 224)^{0.5} \times 224] + 16 = 232^* \end{aligned}$$

*rounded to the nearest integer

The gamma curves in Figures 46 and 47 are examples only; any user defined curve is acceptable in the range of 16 to 240.

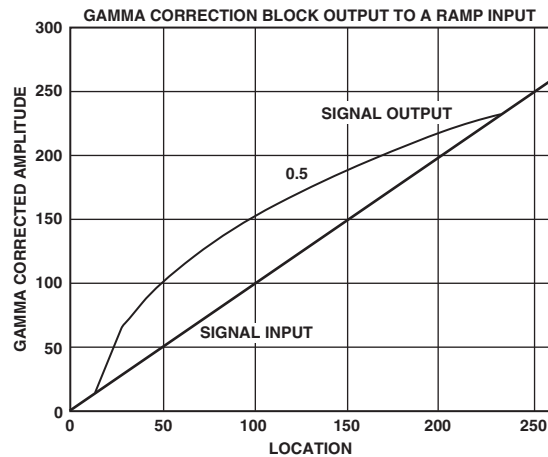

Figure 41. Signal Input (Ramp) and Signal Output for Gamma 0.5

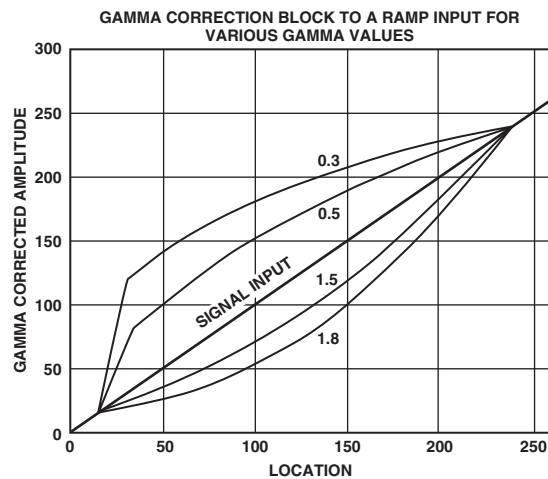

Figure 42. Signal Input (Ramp) and Selectable Output Curves

HD SHARPNESS FILTER CONTROL AND ADAPTIVE FILTER CONTROL

[Subaddress 20h, 38h-3Dh]

There are three filter modes available on the ADV7310/ADV7311: sharpness filter mode and two adaptive filter modes.

HD Sharpness Filter Mode

To enhance or attenuate the Y signal in the frequency ranges shown in the figures below, the following register settings must be used: HD sharpness filter must be enabled and HD adaptive filter enable must be set to disabled.

To select one of the 256 individual responses, the according gain values for each filter, which range from -8 to $+7$, must be programmed into the HD sharpness filter gain register at Address 20h.

HD Adaptive Filter Mode

The HD adaptive filter threshold A, B, C registers, the HD adaptive filter gain 1, 2, 3 registers, and the HD sharpness gain register are used in adaptive filter mode. To activate the adaptive filter control, the HD sharpness filter must be enabled and HD adaptive filter enable must be enabled.

The derivative of the incoming signal is compared to the three programmable threshold values: HD adaptive filter threshold A, B, C. The recommended threshold range is from 16 to 235 although any value in the range of 0 to 255 can be used.

The edges can then be attenuated with the settings in HD adaptive filter gain 1, 2, 3 registers and HD sharpness filter gain register.

According to the settings of the HD adaptive filter mode control, there are two adaptive filter modes available:

1. Mode A is used when adaptive filter mode is set to 0. In this case, Filter B (LPF) will be used in the adaptive filter block. Also, only the programmed values for Gain B in the HD sharpness filter gain, HD adaptive filter gain 1, 2, 3 are applied when needed. The Gain A values are fixed and cannot be changed.
2. Mode B is used when adaptive filter mode is set to 1. In this mode, a cascade of Filter A and Filter B is used. Both settings for Gain A and Gain B in the HD sharpness filter gain, HD adaptive filter gain 1, 2, 3 become active when needed.

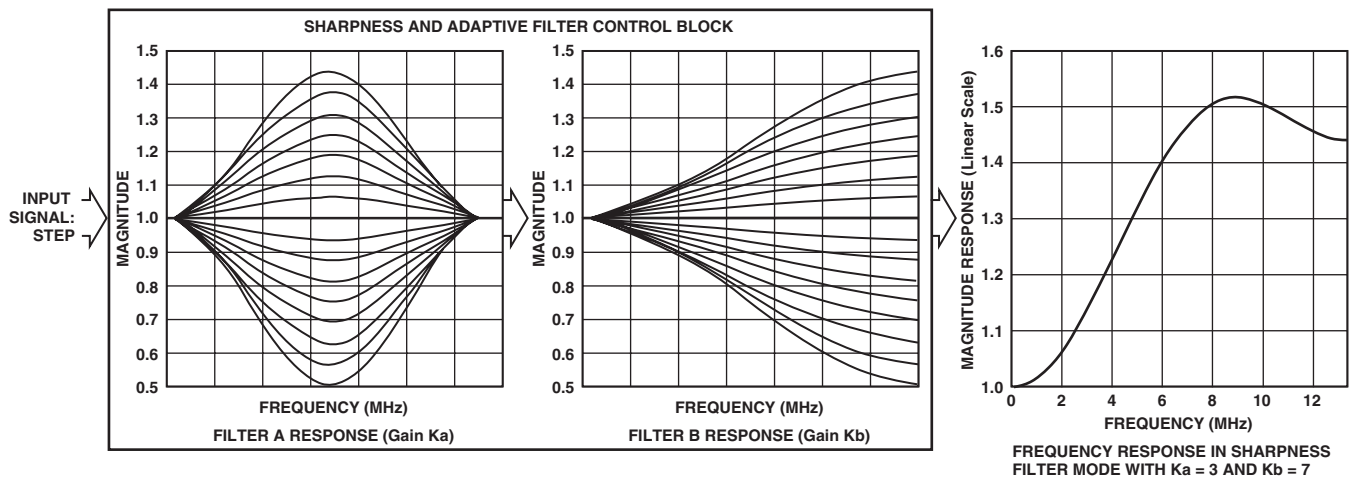

Figure 43. Sharpness and Adaptive Filter Control Block

ADV7310/ADV7311

HD Sharpness Filter and Adaptive Filter Application Examples

HD Sharpness Filter Application

The HD sharpness filter can be used to enhance or attenuate the Y video output signal. The following register settings were used to achieve the results shown in the figures below. Input data was generated by an external signal source.

Table XII.

Address	Register Setting	Reference*
00h	FCh	
01h	10h	
02h	20h	
10h	00h	
11h	81h	
20h	00h	a
20h	08h	b
20h	04h	c
20h	40h	d
20h	80h	e
20h	22h	f

*See Figure 44.

The effect of the sharpness filter can also be seen when using the internally generated cross hatch pattern.

Table XIII.

Address	Register Setting
00h	FCh
01h	10h
02h	20h
10h	00h
11h	85h
20h	99h

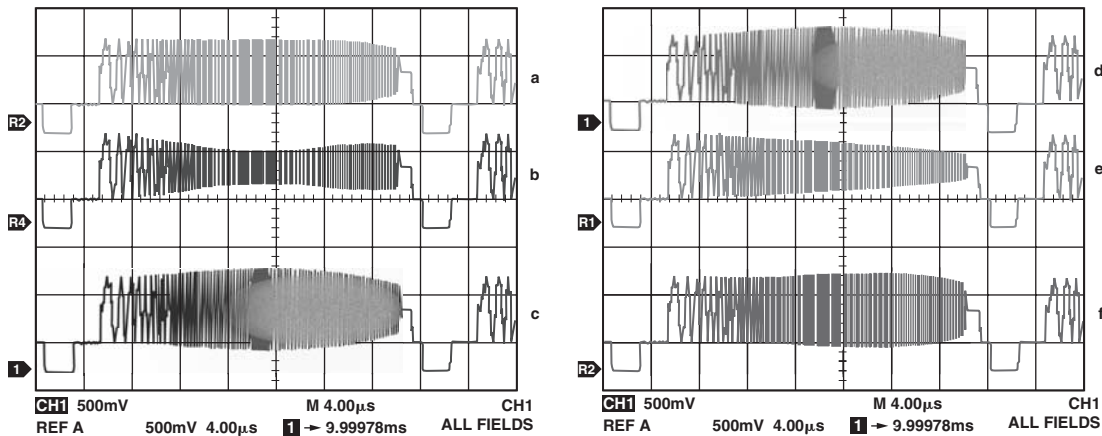

Figure 44. HD Sharpness Filter Control with Different Gain Settings for HS Sharpness Filter Gain Value

Adaptive Filter Control Application

Figures 45 and 46 show typical signals to be processed by the adaptive filter control block.

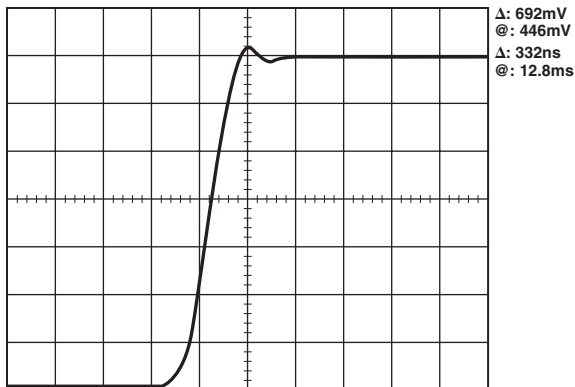

Figure 45. Input Signal to Adaptive Filter Control

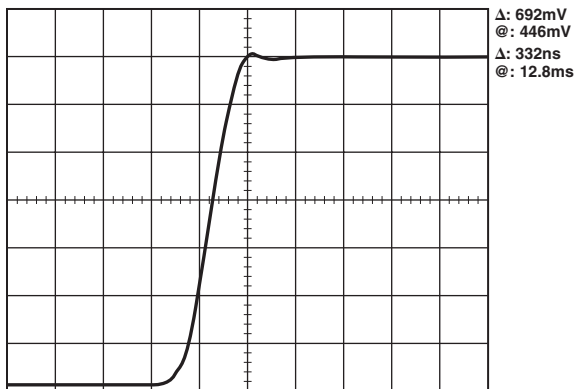

Figure 46. Output Signal after Adaptive Filter Control

The following register settings were used to obtain the results shown in Figure 46, i.e., to remove the ringing on the Y signal. Input data was generated by an external signal source.

Table XIV.

Address	Register Setting
00h	FCh
01h	38h
02h	20h
10h	00h
11h	81h
15h	80h
20h	00h
38h	ACh
39h	9Ah
3Ah	88h
3Bh	28h
3Ch	3Fh
3Dh	64h

All other registers are set as normal/default.

When changing the adaptive filter mode to Mode B [Address 15h, Bit 6], the following output can be obtained:

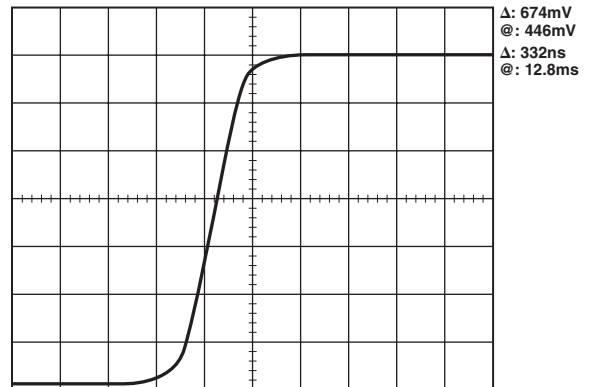

Figure 47. Output Signal from Adaptive Filter Control

The adaptive filter control can also be demonstrated using the internally generated cross hatch test pattern and toggling the adaptive filter control bit [Address 15h, Bit 7].

Table XV.

Address	Register Setting
00h	FCh
01h	38h
02h	20h
10h	00h
11h	85h
15h	80h
20h	00h
38h	ACh
39h	9Ah
3Ah	88h
3Bh	28h
3Ch	3Fh
3Dh	64h

ADV7310/ADV7311

SD Digital Noise Reduction

[Subaddress 63h, 64h, 65h]

DNR is applied to the Y data only. A filter block selects the high frequency, low amplitude components of the incoming signal [DNR input select]. The absolute value of the filter output is compared to a programmable threshold value [DNR threshold control]. There are two DNR modes available: DNR mode and DNR sharpness mode.

In DNR mode, if the absolute value of the filter output is smaller than the threshold, it is assumed to be noise. A programmable amount [coring gain border, coring gain data] of this noise signal will be subtracted from the original signal. In DNR sharpness mode, if the absolute value of the filter output is less than the programmed threshold, it is assumed to be noise, as before. Otherwise, if the level exceeds the threshold, now being identified as a valid signal, a fraction of the signal [coring gain border, coring gain data] will be added to the original signal in order to boost high frequency components and sharpen the video image.

In MPEG systems, it is common to process the video information in blocks of 8 pixels \times 8 pixels for MPEG2 systems, or 16 pixels \times 16 pixels for MPEG1 systems [block size control]. DNR can be applied to the resulting block transition areas that are known to contain noise. Generally, the block transition area contains two pixels. It is possible to define this area to contain four pixels [border area].

It is also possible to compensate for variable block positioning or differences in YCrCb pixel timing with the use of the [DNR block offset].

The digital noise reduction registers are three 8-bit registers. They are used to control the DNR processing.

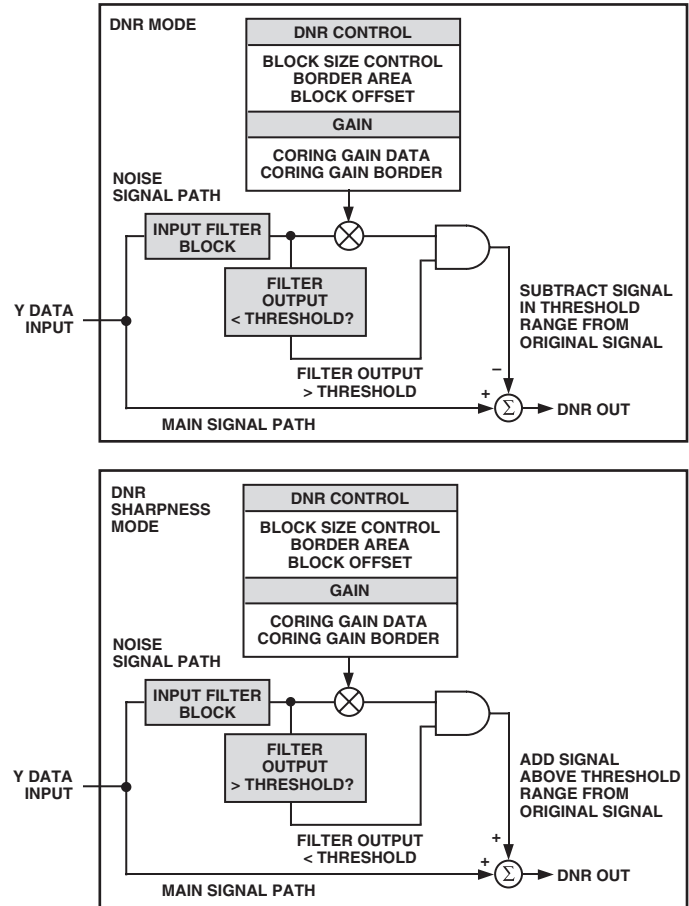

Figure 48. DNR Block Diagram

Coring Gain Border

[Address 63h, Bits 3–0]

These four bits are assigned to the gain factor applied to border areas.

In DNR mode, the range of gain values is 0 to 1 in increments of 1/8. This factor is applied to the DNR filter output, which lies below the set threshold range. The result is then subtracted from the original signal.

In DNR sharpness mode, the range of gain values is 0 to 0.5 in increments of 1/16. This factor is applied to the DNR filter output, which lies above the threshold range.

The result is added to the original signal.

Coring Gain Data

[Address 63h, Bits 7–4]

These four bits are assigned to the gain factor applied to the luma data inside the MPEG pixel block.

In DNR mode, the range of gain values is 0 to 1 in increments of 1/8. This factor is applied to the DNR filter output, which lies below the set threshold range. The result is then subtracted from the original signal.

In DNR sharpness mode, the range of gain values is 0 to 0.5 in increments of 1/16. This factor is applied to the DNR filter output, which lies above the threshold range.

The result is added to the original signal.

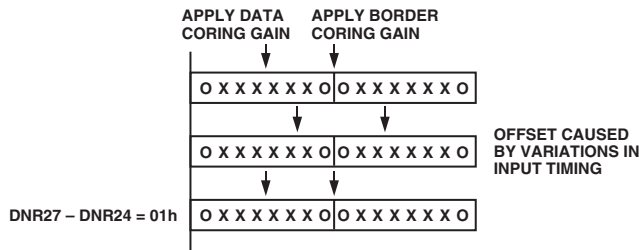

Figure 49. DNR Offset Control

DNR Threshold

[Address 64h, Bits 5–0]

These six bits are used to define the threshold value in the range of 0 to 63. The range is an absolute value.

Border Area

[Address 64h, Bit 6]

When this bit is set to a Logic 1, the block transition area can be defined to consist of four pixels. If this bit is set to a Logic 0, the border transition area consists of two pixels, where one pixel refers to two clock cycles at 27 MHz.

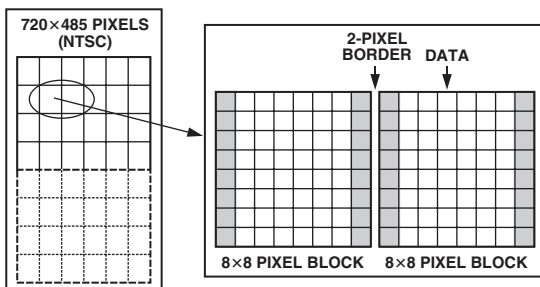

Figure 50. DNR Border Area

Block Size Control

[Address 64h, Bit 7]

This bit is used to select the size of the data blocks to be processed. Setting the block size control function to a Logic 1 defines a 16 pixel × 16 pixel data block, and a Logic 0 defines an 8 pixel × 8 pixel data block, where one pixel refers to two clock cycles at 27 MHz.

DNR Input Select Control

[Address 65h, Bit 2–0]

Three bits are assigned to select the filter, which is applied to the incoming Y data. The signal that lies in the pass band of the selected filter is the signal that will be DNR processed. Figure 51 shows the filter responses selectable with this control.

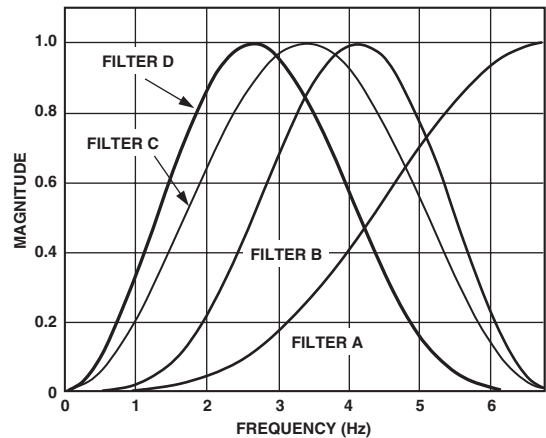

Figure 51. DNR Input Select

DNR Mode Control

[Address 65h, Bit 4]

This bit controls the DNR mode selected. A Logic 0 selects DNR mode; a Logic 1 selects DNR sharpness mode.

DNR works on the principle of defining low amplitude, high frequency signals as probable noise and subtracting this noise from the original signal.

In DNR mode, it is possible to subtract a fraction of the signal that lies below the set threshold, assumed to be noise, from the original signal. The threshold is set in DNR Register 1.

When DNR sharpness mode is enabled, it is possible to add a fraction of the signal that lies above the set threshold to the original signal, since this data is assumed to be valid data and not noise. The overall effect is that the signal will be boosted (similar to using Extended SSAF filter).

Block Offset Control

[Address 65h, Bits 7–4]

Four bits are assigned to this control, which allows a shift of the data block of 15 pixels maximum. Consider the coring gain positions fixed. The block offset shifts the data in steps of one pixel such that the border coring gain factors can be applied at the same position regardless of variations in input timing of the data.

ADV7310/ADV7311

SD ACTIVE VIDEO EDGE

[Subaddress 42h, Bit 7]

When the active video edge is enabled, the first three pixels and the last three pixels of the active video on the luma channel are scaled in such a way that maximum transitions on these pixels are not possible. The scaling factors are $\times 1/8$, $\times 1/2$, and $\times 7/8$. All other active video passes through unprocessed.

SAV/EAV Step Edge Control

The ADV7310/ADV7311 has the capability of controlling fast rising and falling signals at the start and end of active video to minimize ringing.

An algorithm monitors SAV and EAV and governs when the edges are too fast. The result will be reduced ringing at the start and end of active video for fast transitions.

Subaddress 0x42, Bit 7 = 1 enables this feature.

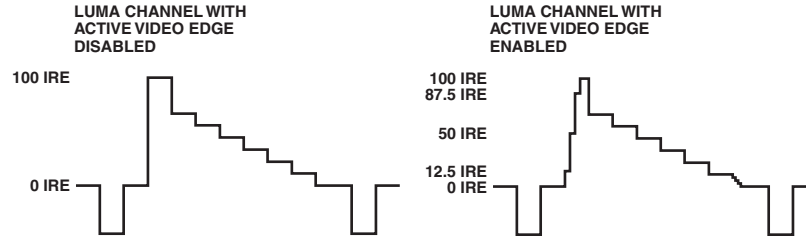

Figure 52. Example of Active Video Edge Functionality

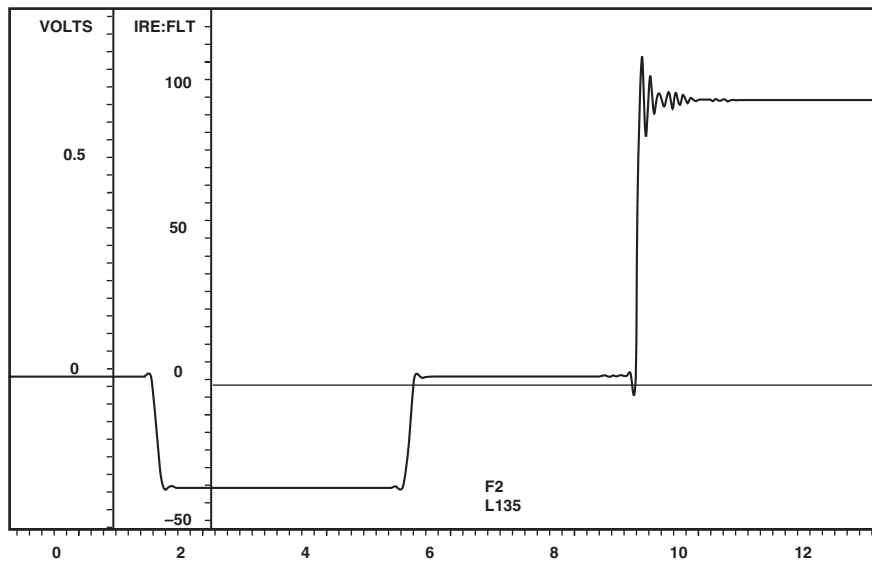

Figure 53. Address 0x42, Bit 7 = 0

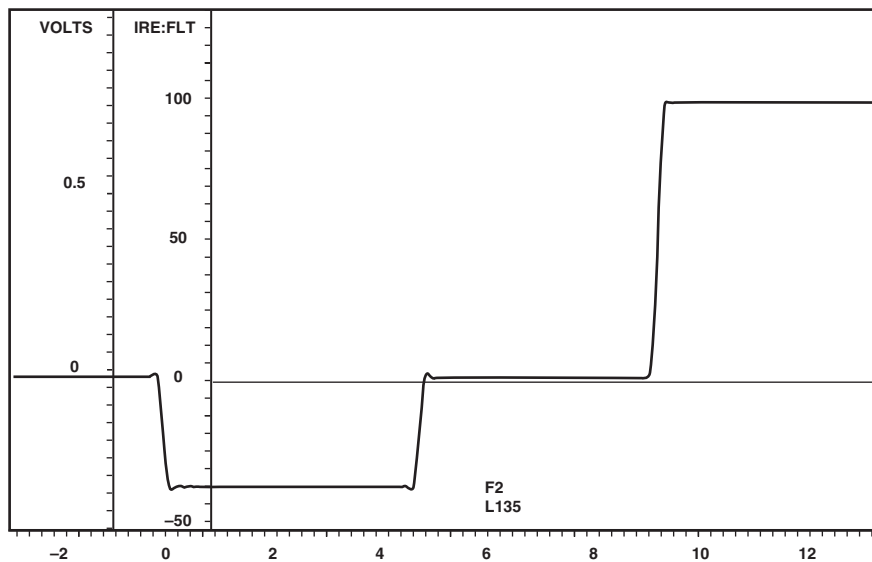

Figure 54. Address 0x42, Bit 7 = 1

BOARD DESIGN AND LAYOUT CONSIDERATIONS

DAC Termination and Layout Considerations

The ADV7310/ADV7311 contain an on-board voltage reference. The ADV7310/ADV7311 can be used with an external V_{REF} (AD1580).

The R_{SET} resistors are connected between the R_{SET} pins and AGND and are used to control the full-scale output current and therefore the DAC voltage output levels. For full-scale output, R_{SET} must have a value of $3040\ \Omega$. The R_{SET} values should not be changed. R_{LOAD} has a value of $300\ \Omega$ for full-scale output.

Video Output Buffer and Optional Output Filter

Output buffering on all six DACs is necessary in order to drive output devices, such as SD or HD monitors. Analog Devices produces a range of suitable op amps for this application, for example the AD8061. More information on line driver buffering circuits is given in the relevant op amps' data sheets.

An optional analog reconstruction low-pass filter (LPF) may be required as an anti-imaging filter if the ADV7310/ADV7311 is connected to a device that requires this filtering.

The filter specifications vary with the application.

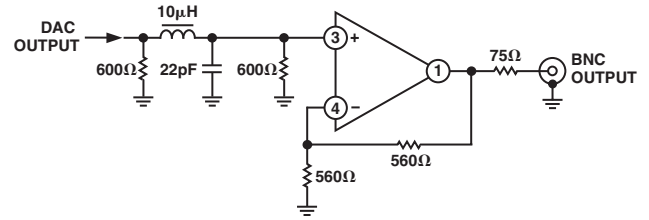

Figure 55. Example of Output Filter for SD, 16× Oversampling

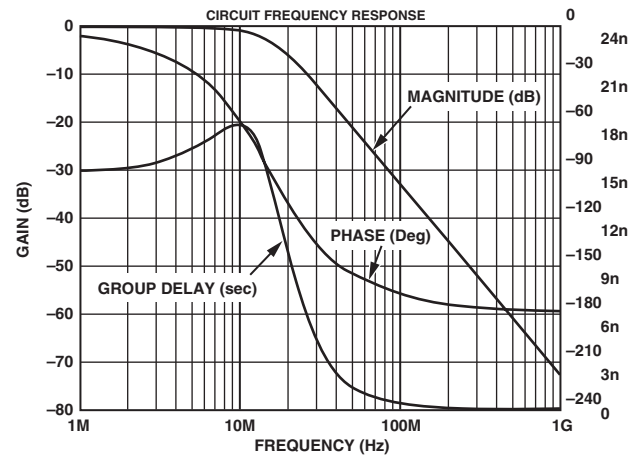

Figure 56. Filter Plot for Output Filter for SD, 16× Oversampling

Table XVI. External Filter Requirements

Application	Oversampling	Cutoff Frequency (MHz)	Attenuation -50 dB @ (MHz)
SD	2×	>6.5	20.5
SD	16×	>6.5	209.5
PS	1×	>12.5	14.5
PS	8×	>12.5	203.5
HDTV	1×	>30	44.25
HDTV	2×	>30	118.5

ADV7310/ADV7311

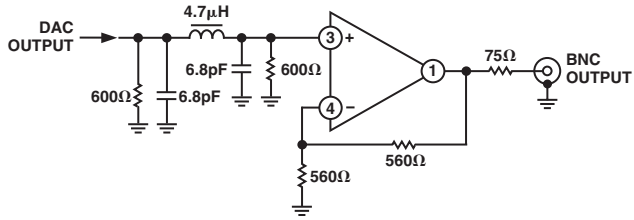

Figure 57. Example of Output Filter for PS, 8x Oversampling

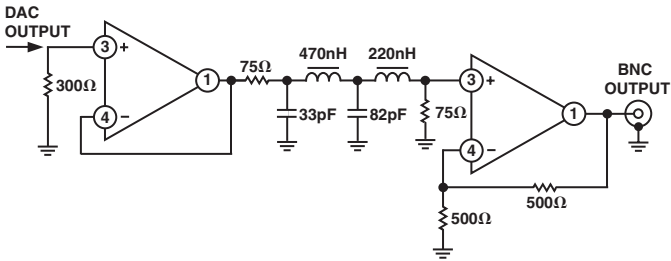

Figure 58. Example of Output Filter for HDTV, 2x Oversampling

Table XVII. Possible Output Rates From the ADV7310/ADV7311

Input Mode Address 01h, Bit 6-4	PLL Address 00h, Bit 1	Output Rate (MHz)
SD Only	Off	27 (2x)
	On	216 (16x)
PS Only	Off	27 (1x)
	On	216 (8x)
HDTV Only	Off	74.25 (1x)
	On	148.5 (2x)

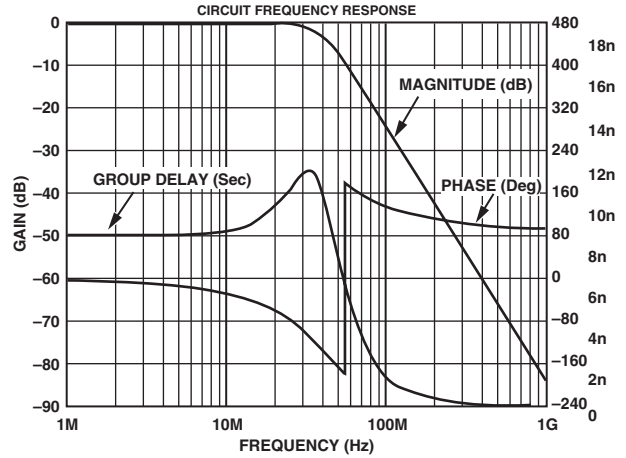

Figure 59. Filter Plot for Output Filter for PS, 8x Oversampling

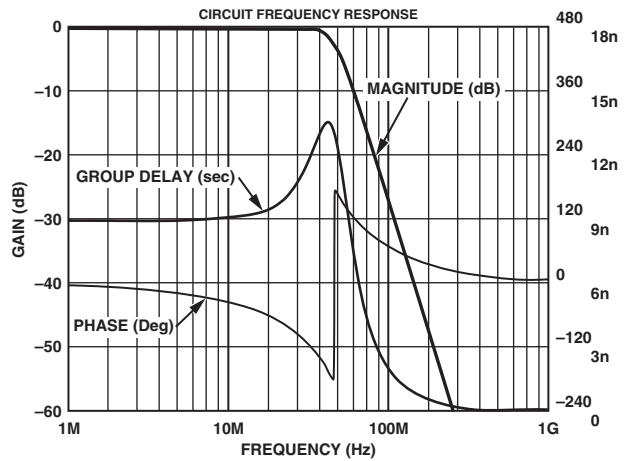

Figure 60. Filter Plot for Output Filter for HDTV, 2x Oversampling

PCB Board Layout Considerations

The ADV7310/ADV7311 are optimally designed for lowest noise performance, both radiated and conducted noise. To complement the excellent noise performance of the ADV7310/ADV7311, it is imperative that great care be given to the PC board layout.

The layout should be optimized for lowest noise on the ADV7310/ADV7311 power and ground lines. This can be achieved by shielding the digital inputs and providing good decoupling. The lead length between groups of V_{AA} and AGND, V_{DD} and DGND, and V_{DD_IO} and GND_IO pins should be kept as short as possible to minimized inductive ringing.

It is recommended that a 4-layer printed circuit board is used, with power and ground planes separating the layer of the signal carrying traces of the components and solder side layer. Component placement should be carefully considered in order to separate noisy circuits, such as crystal clocks, high speed logic circuitry, and analog circuitry.

There should be a separate analog ground plane and a separate digital ground plane.

Power planes should encompass a digital power plane and an analog power plane. The analog power plane should contain the DACs and all associated circuitry, V_{REF} circuitry. The digital power plane should contain all logic circuitry.

The analog and digital power planes should be individually connected to the common power plane at a single point through a suitable filtering device, such as a ferrite bead.

DAC output traces on a PCB should be treated as transmission lines. It is recommended that the DACs be placed as close as possible to the output connector, with the analog output traces being as short as possible (less than 3 inches). The DAC termination resistors should be placed as close as possible to the DAC outputs and should overlay the PCB's ground plane. As well as minimizing reflections, short analog output traces will reduce noise pickup due to neighboring digital circuitry.

To avoid crosstalk between the DAC outputs, it is recommended that as much space as possible be left between the tracks of the individual DAC output pins. The addition of ground tracks between outputs is also recommended.

Supply Decoupling

Noise on the analog power plane can be further reduced by the use of decoupling capacitors.

Optimum performance is achieved by the use of 10 nF and 0.1 μ F ceramic capacitors. Each group of V_{AA} , V_{DD} , or V_{DD_IO} pins should be individually decoupled to ground. This should be done by placing the capacitors as close as possible to the device with the capacitor leads as short as possible, thus minimizing lead inductance.

A 1 μ F tantalum capacitor is recommended across the V_{AA} supply in addition to 10 nF ceramic.

See the circuit layout in Figure 61.

Digital Signal Interconnect

The digital signal lines should be isolated as much as possible from the analog outputs and other analog circuitry. Digital signal lines should not overlay the analog power plane.

Due to the high clock rates used, long clock lines to the ADV7310/ADV7311 should be avoided to minimize noise pickup.

Any active pull-up termination resistors for the digital inputs should be connected to the digital power plane and not the analog power plane.

Analog Signal Interconnect

The ADV7310/ADV7311 should be located as close as possible to the output connectors, thus minimizing noise pickup and reflections due to impedance mismatch.

For optimum performance, the analog outputs should each be source and load terminated, as shown in Figure 61. The termination resistors should be as close as possible to the ADV7310/ADV7311 to minimize reflections.

For optimum performance, it is recommended that all decoupling and external components relating to the ADV7310/ADV7311 be located on the same side of the PCB and as close as possible to the ADV7310/ADV7311.

Any unused inputs should be tied to ground.

ADV7310/ADV7311

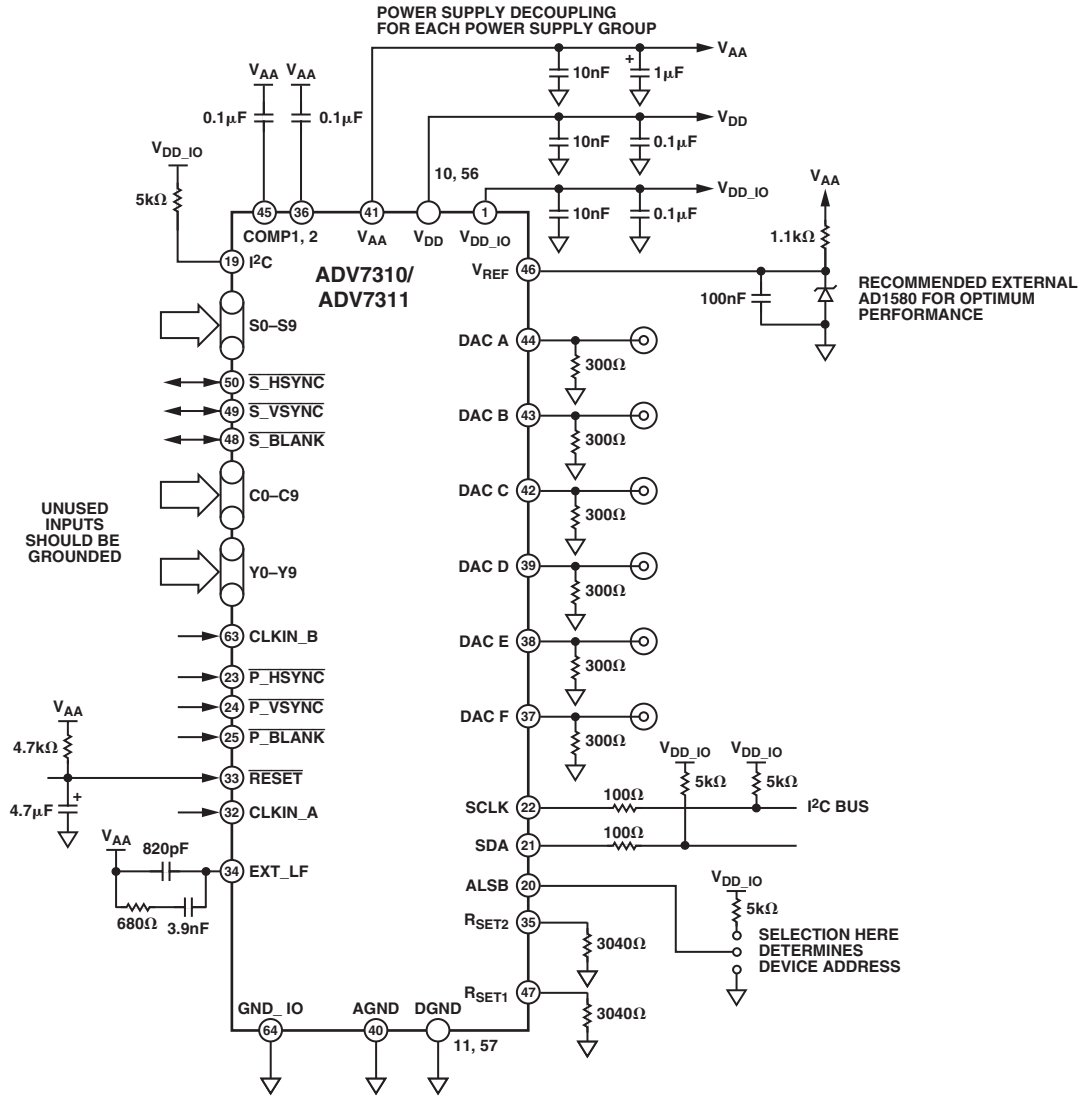

Figure 61. ADV7310/ADV7311 Circuit Layout

APPENDIX 1—COPY GENERATION MANAGEMENT SYSTEM

PS CGMS Data Registers 2–0

[Subaddress 21h, 22h, 23h]

PS CGMS is available in 525p mode conforming to CGMS-A EIA-J CPR1204-1, transfer method of video ID information using vertical blanking interval (525p system), March 1998, and IEC61880, 1998, Video systems (525/60)—video and accompanied data using the vertical blanking interval— analog interface.

When PS CGMS is enabled [Subaddress 12h, Bit 6 = 1], CGMS data is inserted on line 41. The PS CGMS data registers are at Addresses 21h, 22h, and 23h.

SD CGMS Data Registers 2–0

[Subaddress 59h, 5Ah, 5Bh]

The ADV7310/ADV7311 supports Copy Generation Management System (CGMS), conforming to the standard. CGMS data is transmitted on Line 20 of the odd fields and Line 283 of even fields. Bits C/W05 and C/W06 control whether or not CGMS data is output on odd and even fields. CGMS data can be transmitted only when the ADV7310/ADV7311 is configured in NTSC mode. The CGMS data is 20 bits long, and the function of each of these bits is as shown in the following table. The CGMS data is preceded by a reference pulse of the same amplitude and duration as a CGMS bit; see Figure 63.

HD/PS CGMS [Address 12h, Bit 6]

The ADV7310/ADV7311 supports Copy Generation Management System (CGMS) in HDTV mode (720p and 1080i) in accordance with EIAJ CPR-1204-2.

The HD CGMS data registers are to be found at address 021h, 22h, 23h.

Function of CGMS Bits

Word 0–6 bits; Word 1–4 bits; Word 2–6 bits; CRC 6 bits CRC polynomial = $x^6 + x + 1$ (preset to 111111)

720p System

CGMS data is applied to Line 24 of the luminance vertical blanking interval.

1080i System

CGMS data is applied to Line 19 and on Line 582 of the luminance vertical blanking interval.

CGMS Functionality

If SD CGMS CRC [Address 59h, Bit 4] or PS/HD CGMS CRC [Subaddress 12h, Bit 7] is set to a Logic 1, the last six bits, C19–C14, which comprise the 6-bit CRC check sequence, are calculated automatically on the ADV7310/ADV7311 based on the lower 14 bits (C0–C13) of the data in the data registers and output with the remaining 14 bits to form the complete 20 bits of the CGMS data. The calculation of the CRC sequence is based on the polynomial $x^6 + x + 1$ with a preset value of 111111. If SD CGMS CRC [Address 59h, Bit 4] and PS/HD CGMS CRC [Address 12h, Bit 7] is set to a Logic 0, all 20 bits (C0–C19) are output directly from the CGMS registers (no CRC is calculated, must be calculated by the user).

Table XVIII.

Bit	Function
WORD0	1 0
B1	Aspect ratio 16:9 4:3
B2	Display format Letterbox Normal
B3	Undefined
WORD0	
B4, B5, B6	Identification information about video and other signals (e.g., audio)
WORD1	
B7, B8, B9, B10	Identification signal incidental to Word 0
WORD2	
B11, B12, B13, B14	Identification signal and information incidental to Word 0

ADV7310/ADV7311

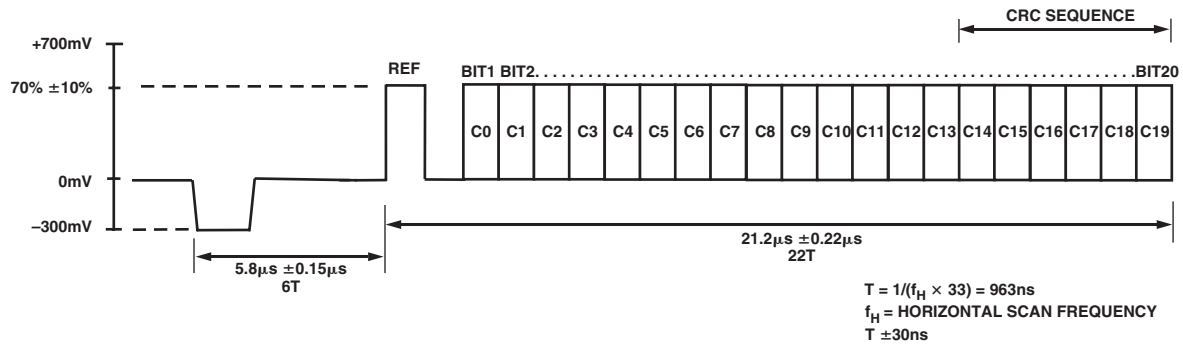

Figure 62. Progressive Scan CGMS Waveform

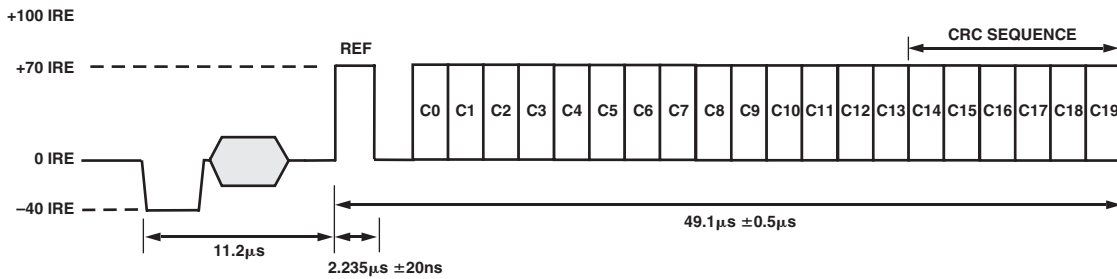

Figure 63. Standard Definition CGMS Waveform Diagram

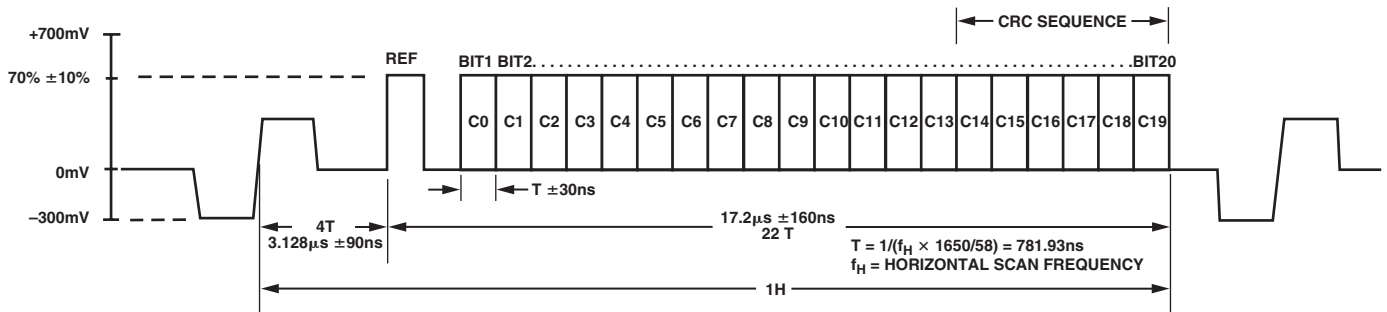

Figure 64. HDTV 720p CGMS Waveform

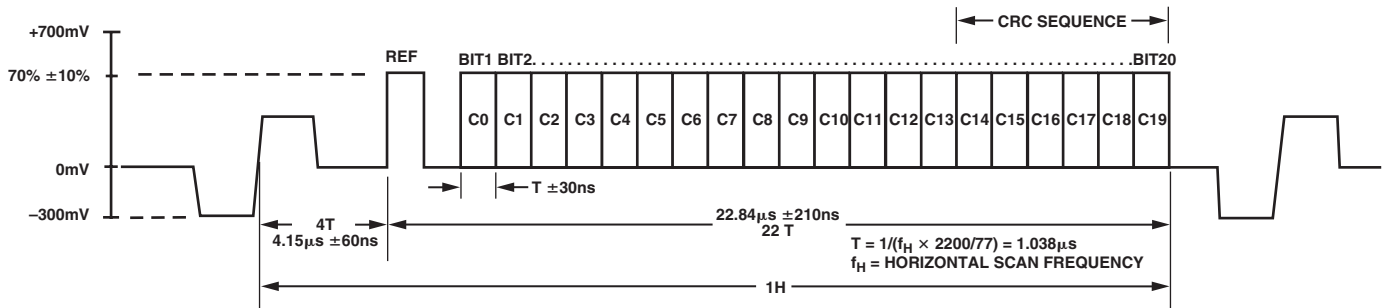

Figure 65. HDTV 1080i CGMS Waveform

APPENDIX 2—SD WIDE SCREEN SIGNALING

[Subaddress 59h, 5Ah, 5Bh]

The ADV7310/ADV7311 support wide screen signaling (WSS) conforming to the standard. WSS data is transmitted on Line 23. WSS data can be transmitted only when the device is configured in PAL mode. The WSS data is 14 bits long, and the function of each of these bits is shown in Table XIX. The WSS data is

preceded by a run-in sequence and a start code; see Figure 66. If SD WSS [Address 59h, Bit 7] is set to a Logic 1, it enables the WSS data to be transmitted on Line 23. The latter portion of Line 23 (42.5 μ s from the falling edge of $\overline{\text{HSYNC}}$) is available for the insertion of video.

It is possible to blank the WSS portion of Line 23 with Subaddress 61h, Bit 7.

Table XIX. Function of WSS Bits

Bit	Description	Bit	Description
Bit 0–Bit 2	Aspect Ratio/Format/Position	B5	
Bit 3	Odd Parity Check of Bit 0 to Bit 2	0	Standard Coding
B0, B1, B2, B3	Aspect Ratio Format Position	1	Motion Adaptive Color Plus
0 0 0 1	4:3 Full Format N/A	B6	
1 0 0 0	14:9 Letterbox Center	0	No Helper
0 1 0 0	14:9 Letterbox Top	1	Modulated Helper
1 1 0 1	16:9 Letterbox Center	B7	Reserved
0 0 1 0	16:9 Letterbox Top	B9 B10	
1 0 1 1	>16:9 Letterbox Center	0 0	No Open Subtitles
0 1 1 1	14:9 Full Format Center	1 0	Subtitles in Active Image Area
1 1 1 0	16:9 N/A N/A	0 1	Subtitles out of Active Image Area
1 1 1 0	16:9	1 1	Reserved
B4		B11	
0	Camera Mode	0	No Surround Sound Information
1	Film Mode	1	Surround Sound Mode
		B12	Reserved
		B13	Reserved

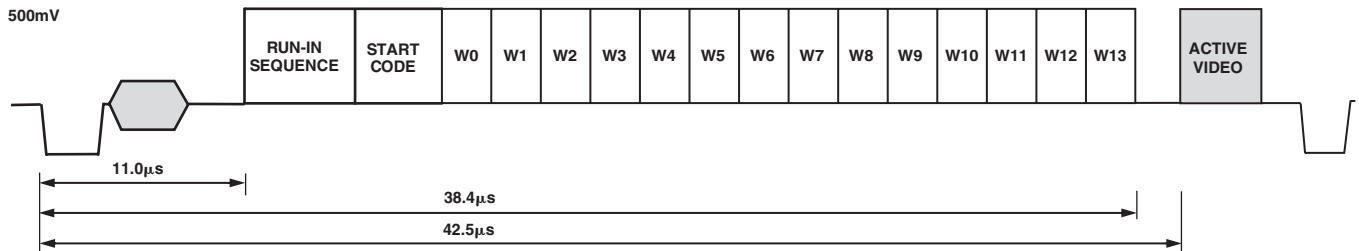

Figure 66. WSS Waveform Diagram

ADV7310/ADV7311

APPENDIX 3—SD CLOSED CAPTIONING

[Subaddress 51h–54h]

The ADV7310/ADV7311 support closed captioning conforming to the standard television synchronizing waveform for color transmission. Closed captioning is transmitted during the blanked active line time of Line 21 of the odd fields and Line 284 of the even fields.

Closed captioning consists of a 7-cycle sinusoidal burst that is frequency and phase locked to the caption data. After the clock run-in signal, the blanking level is held for two data bits and is followed by a Logic 1 start bit. Sixteen bits of data follow the start bit. These consist of two 8-bit bytes, seven data bits, and one odd parity bit. The data for these bytes is stored in the SD closed captioning registers [Address 53h–54h].

The ADV7310/ADV7311 also support the extended closed captioning operation, which is active during even fields and is encoded on Scan Line 284. The data for this operation is stored in the SD closed captioning registers [Address 51h–52h].

All clock run-in signals and timing to support closed captioning on Lines 21 and 284 are generated automatically by the ADV7310/

ADV7311. All pixels inputs are ignored during Lines 21 and 284 if closed captioning is enabled.

FCC Code of Federal Regulations (CFR) 47 section 15.119 and EIA608 describe the closed captioning information for Lines 21 and 284.

The ADV7310/ADV7311 use a single buffering method. This means that the closed captioning buffer is only 1-byte deep; therefore there will be no frame delay in outputting the closed captioning data unlike other 2-byte deep buffering systems. The data must be loaded one line before (Line 20 or Line 283) it is output on Line 21 and Line 284. A typical implementation of this method is to use \overline{VSYNC} to interrupt a microprocessor, which in turn will load the new data (two bytes) in every field. If no new data is required for transmission, 0s must be inserted in both data registers; this is called *nulling*. It is also important to load control codes, all of which are double bytes on Line 21, or a TV will not recognize them. If there is a message like “Hello World” that has an odd number of characters, it is important to pad it out to even in order to get “end of caption” 2-byte control code to land in the same field.

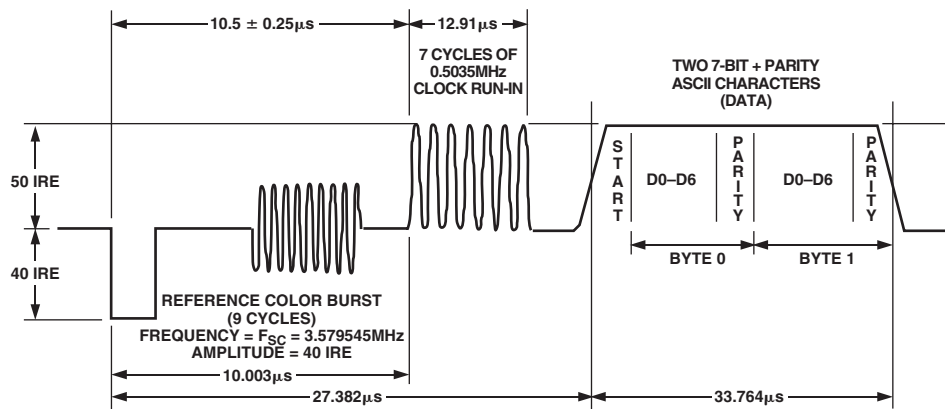

Figure 67. Closed Captioning Waveform, NTSC

APPENDIX 4—TEST PATTERNS

The ADV7310/ADV7311 can generate SD and HD test patterns.

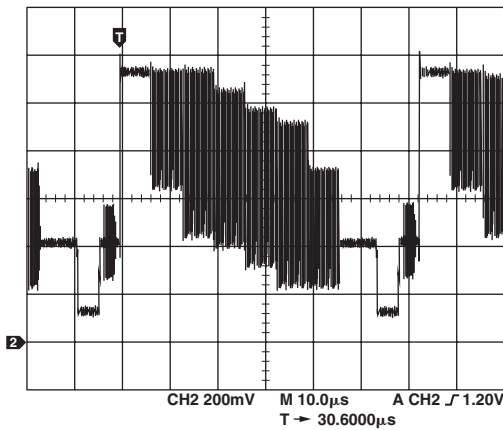

Figure 68. NTSC Color Bars

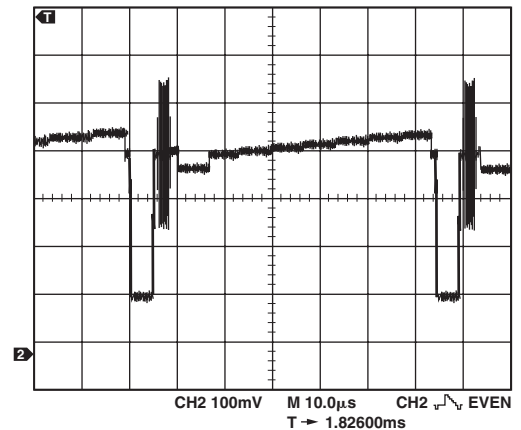

Figure 71. PAL Black Bar [–21 mV, 0 mV, 3.5 mV, 7 mV, 10.5 mV, 14 mV, 18 mV, 23 mV]

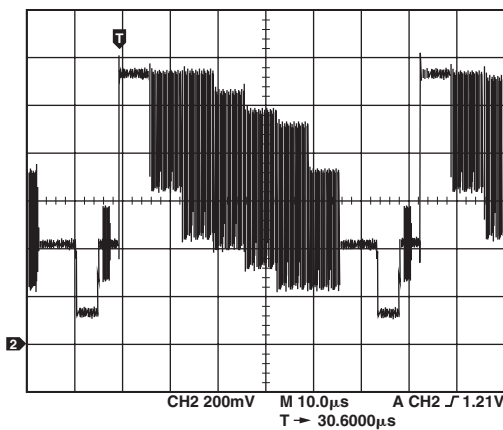

Figure 69. PAL Color Bars

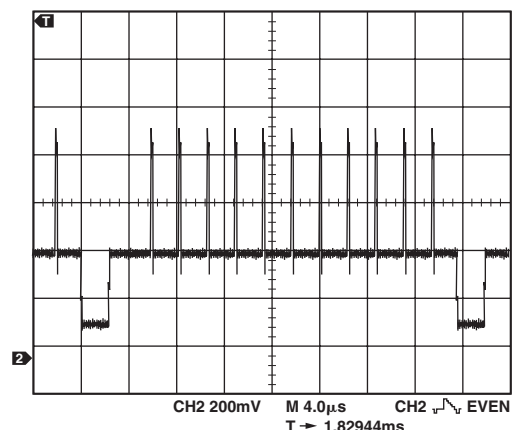

Figure 72. 525p Hatch Pattern

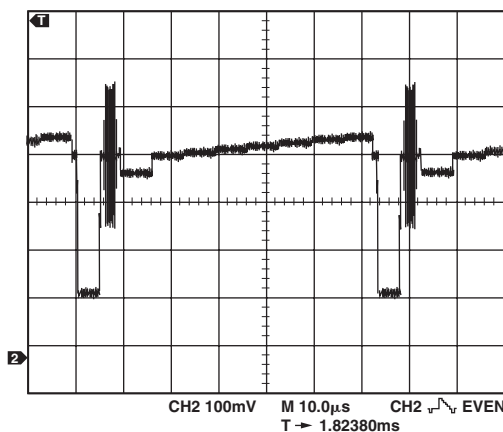

Figure 70. NTSC Black Bar [–21 mV, 0 mV, 3.5 mV, 7 mV, 10.5 mV, 14 mV, 18 mV, 23 mV]

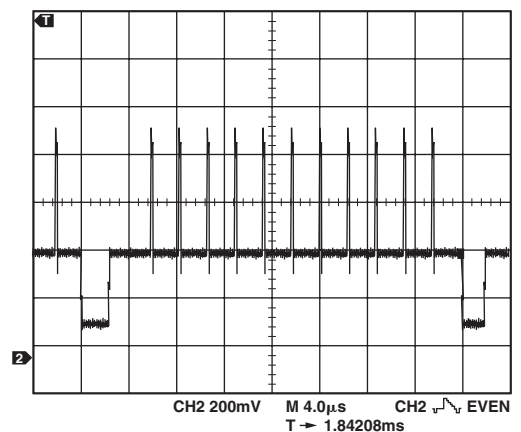

Figure 73. 625p Hatch Pattern

ADV7310/ADV7311

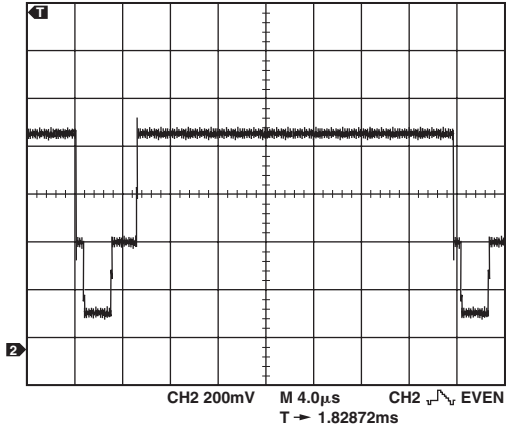

Figure 74. 525p Field Pattern

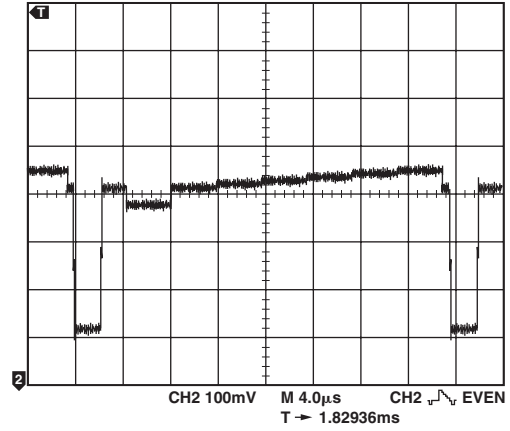

Figure 76. 525p Black Bar [-35 mV, 0 mV, 7 mV, 14 mV, 21 mV, 28 mV, 35 mV]

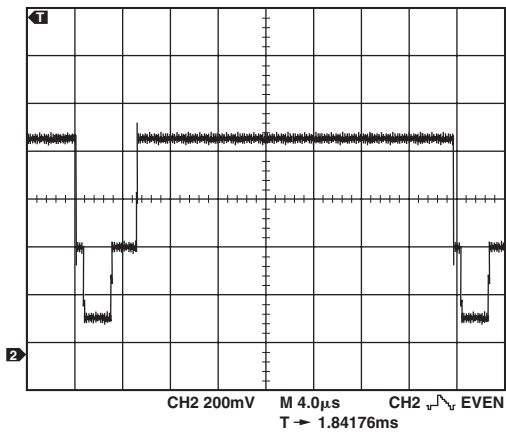

Figure 75. 625p Field Pattern

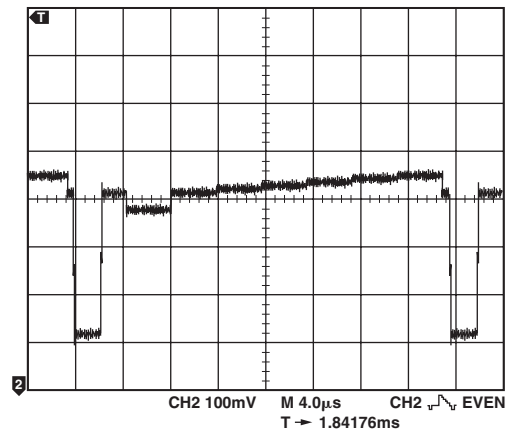

Figure 77. 625p Black Bar [-35 mV, 0 mV, 7 mV, 14 mV, 21 mV, 28 mV, 35 mV]

The following register settings are used to generate an SD NTSC CVBS output on DAC A:

Subaddress	Register Setting
00h	80h
40h	10h
42h	40h
44h	40h
4Ah	08h

All other registers are set as normal/default.

For PAL CVBS output on DAC A, the same settings are used except that subaddress = 40h and register setting = 11h.

The following register settings are used to generate an SD NTSC black bar pattern output on DAC A:

Subaddress	Register Setting
00h	80h
02h	04h
40h	10h
42h	40h
44h	40h
4Ah	08h

All other registers are set as normal/default.

For PAL black bar pattern output on DAC A, the same settings are used except that subaddress = 40h and register setting = 11h.

The following register settings are used to generate a 525p hatch pattern on DAC D:

Subaddress	Register Setting
00h	10h
01h	10h
10h	40h
11h	05h
16h	A0h
17h	80h
18h	80h

All other registers are set as normal/default.

For 625p hatch pattern on DAC D, the same register settings are used except that subaddress = 10h and register setting = 50h.

For a 525p black bar pattern output on DAC D, the same settings are used as above except that subaddress = 02h and register setting = 24h.

For 625p black bar pattern output on DAC D, the same settings are used as above except that subaddress = 02h and register setting = 24h; and subaddress = 10h and register setting = 50h.

ADV7310/ADV7311

APPENDIX 5—SD TIMING MODES

[Subaddress 4Ah]

Mode 0 (CCIR-656)—Slave Option

(Timing Register 0 TR0 = X X X X X 0 0 0)

The ADV7310/ADV7311 is controlled by the SAV (start active video) and EAV (end active video) time codes in the pixel data. All timing information is transmitted using a 4-byte synchronization pattern. A synchronization pattern is sent immediately before and after each line during active picture and retrace. $\overline{S_VSYNC}$, $\overline{S_HSYNC}$, and $\overline{S_BLANK}$ (if not used) pins should be tied high during this mode. Blank output is available.

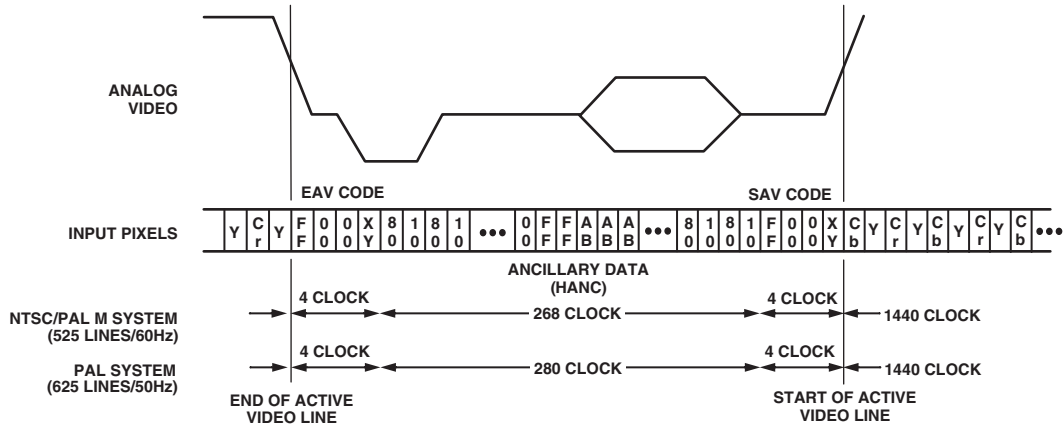

Figure 78. SD Slave Mode 0

Mode 0 (CCIR-656)—Master Option

(Timing Register 0 TR0 = X X X X X 0 0 1)

The ADV7310/ADV7311 generates H, V, and F signals required for the SAV (start active video) and EAV (end active video) time codes in the CCIR656 standard. The H bit is output on the $\overline{S_HSYNC}$, the V bit is output on $\overline{S_BLANK}$, and the F bit is output on $\overline{S_VSYNC}$.

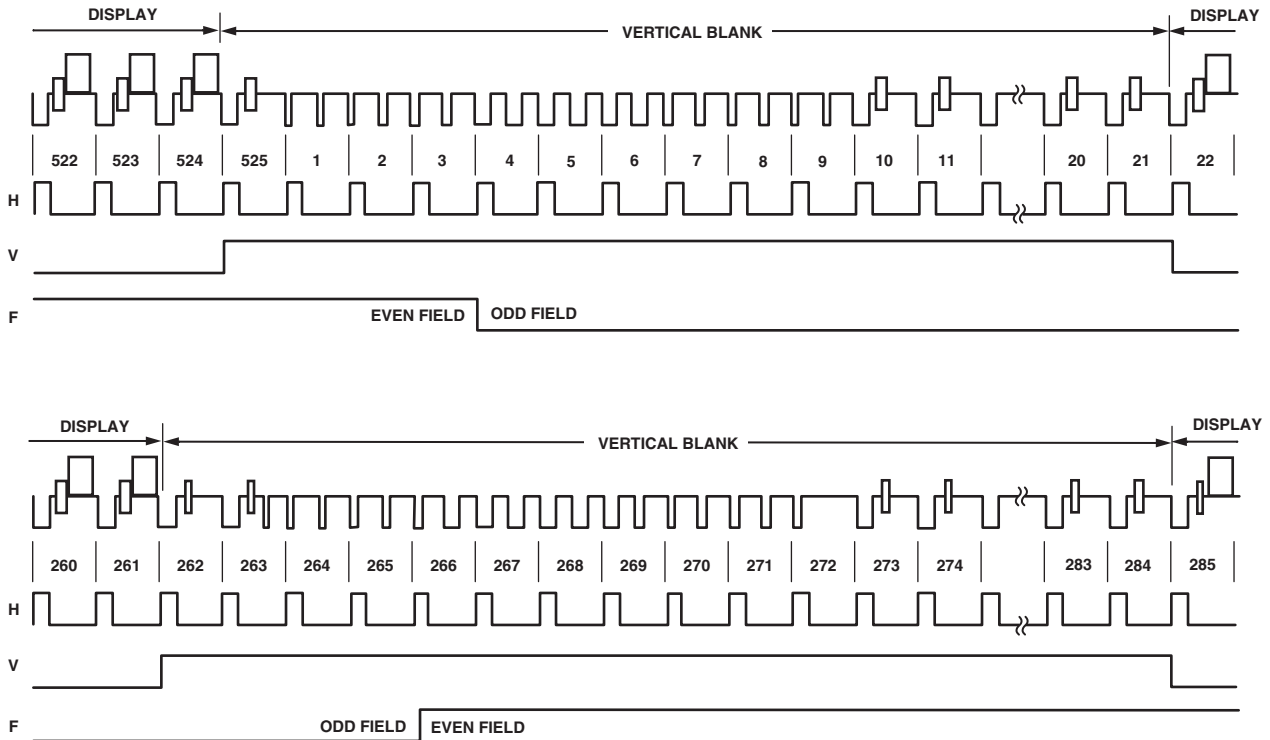

Figure 79. SD Master Mode 0, NTSC

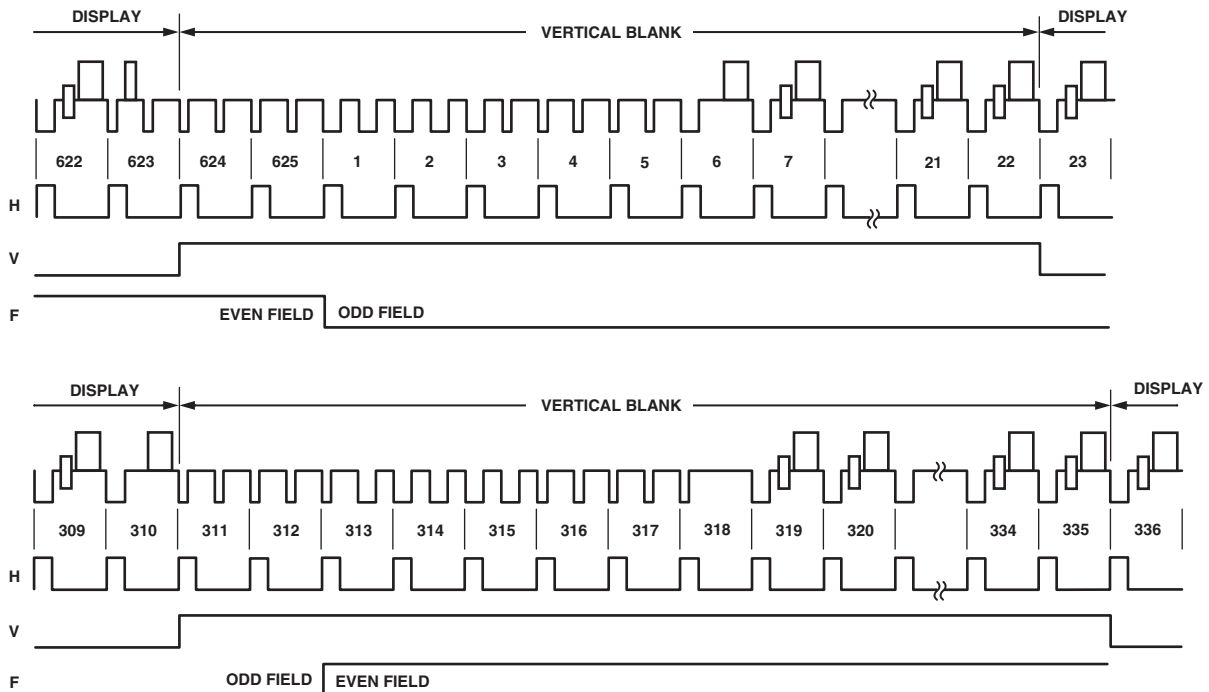

Figure 80. SD Master Mode 0, PAL

ADV7310/ADV7311

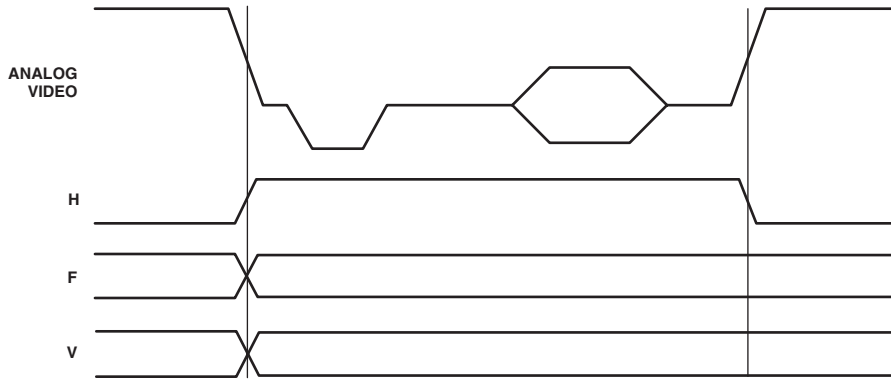

Figure 81. SD Master Mode 0, Data Transitions

Mode 1—Slave Option

(Timing Register 0 TR0 = X X X X X 0 1 0)

In this mode, the ADV7310/ADV7311 accept horizontal sync and odd/even field signals. A transition of the field input when $\overline{\text{HSYNC}}$ is low indicates a new frame, i.e., vertical retrace. The $\overline{\text{BLANK}}$ signal is optional. When the $\overline{\text{BLANK}}$ input is disabled, the ADV7310/ADV7311 automatically blank all normally blank lines as per CCIR-624. $\overline{\text{HSYNC}}$ is input on $\overline{\text{S_HSYNC}}$, $\overline{\text{BLANK}}$ on $\overline{\text{S_BLANK}}$, and FIELD on $\overline{\text{S_VSYNC}}$.

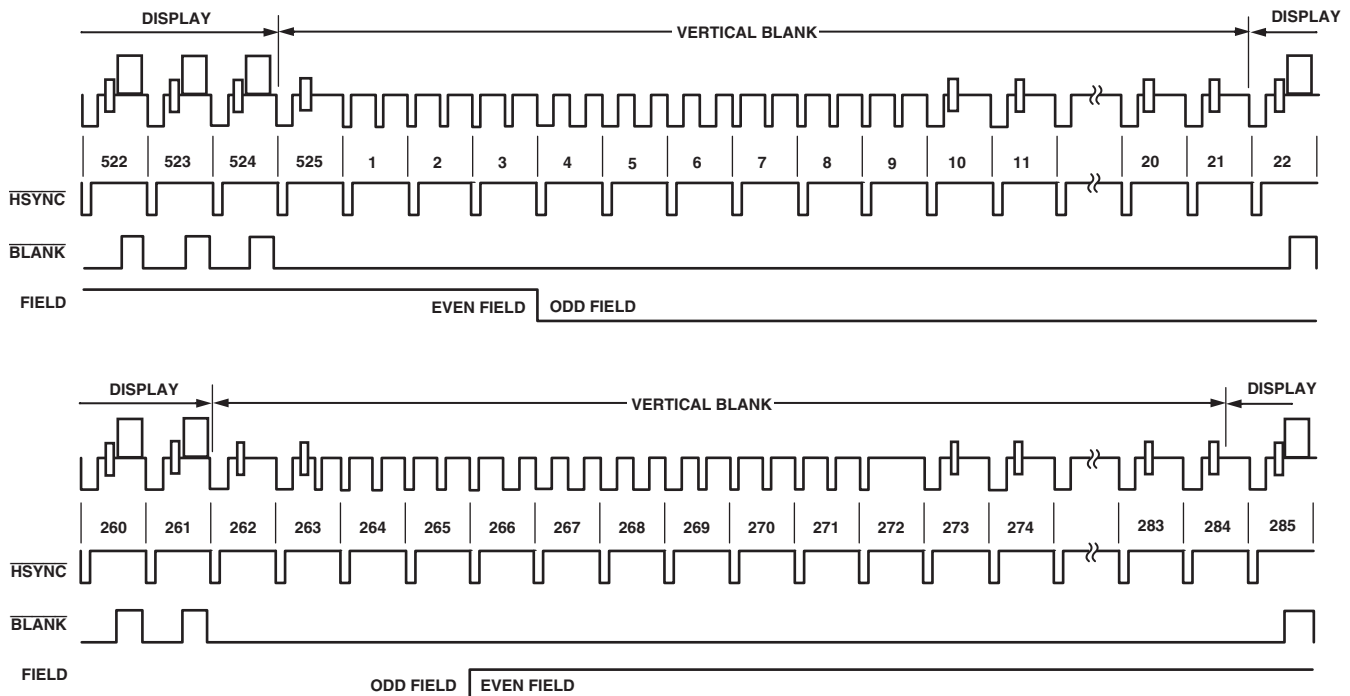

Figure 82. SD Slave Mode 1 (NTSC)

Mode 1—Master Option

(Timing Register 0 TR0 = X X X X X 0 1 1)

In this mode, the ADV7310/ADV7311 can generate horizontal sync and odd/even field signals. A transition of the field input when $\overline{\text{HSYNC}}$ is low indicates a new frame, i.e., vertical retrace. The blank signal is optional. When the $\overline{\text{BLANK}}$ input is disabled, the ADV7310/ADV7311 automatically blank all normally blank lines as per CCIR-624. Pixel data is latched on the rising clock edge following the timing signal transitions. $\overline{\text{HSYNC}}$ is output on the $\overline{\text{S_HSYNC}}$, $\overline{\text{BLANK}}$ on $\overline{\text{S_BLANK}}$, and FIELD on $\overline{\text{S_VSYNC}}$.

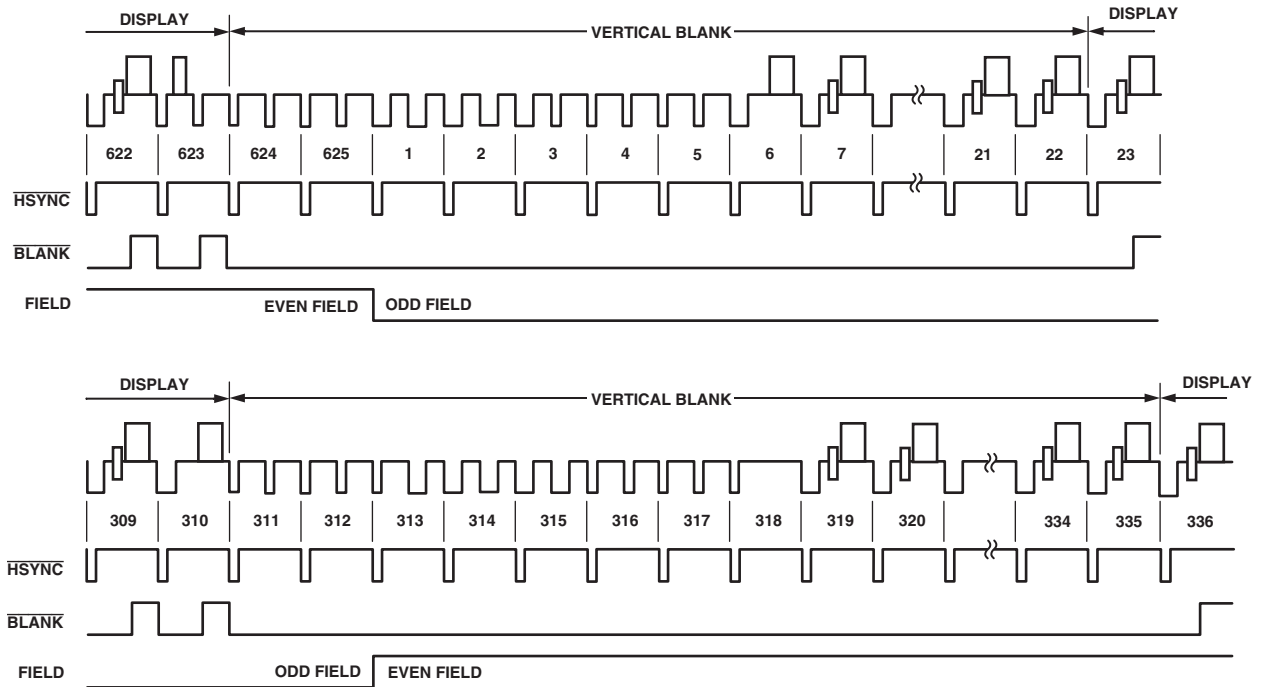

Figure 83. SD Slave Mode 1 (PAL)

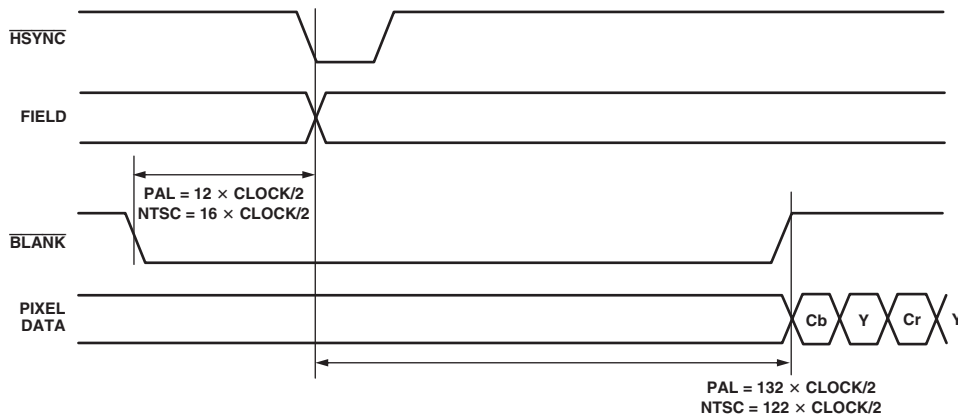

Figure 84. SD Timing Mode 1—Odd/Even Field Transitions Master/Slave

ADV7310/ADV7311

Mode 2— Slave Option

(Timing Register 0 TR0 = X X X X X 1 0 0)

In this mode, the ADV7310/ADV7311 accepts horizontal and vertical sync signals. A coincident low transition of both $\overline{\text{HSYNC}}$ and $\overline{\text{VSYNC}}$ inputs indicates the start of an odd field. A $\overline{\text{VSYNC}}$ low transition when $\overline{\text{HSYNC}}$ is high indicates the start of an even field. The BLANK signal is optional. When the BLANK input is disabled, the ADV7310/ADV7311 automatically blank all normally blank lines as per CCIR-624. $\overline{\text{HSYNC}}$ is input $\overline{\text{S_HSYNC}}$, $\overline{\text{BLANK}}$ on $\overline{\text{S_BLANK}}$, and $\overline{\text{VSYNC}}$ on $\overline{\text{S_VSYNC}}$.

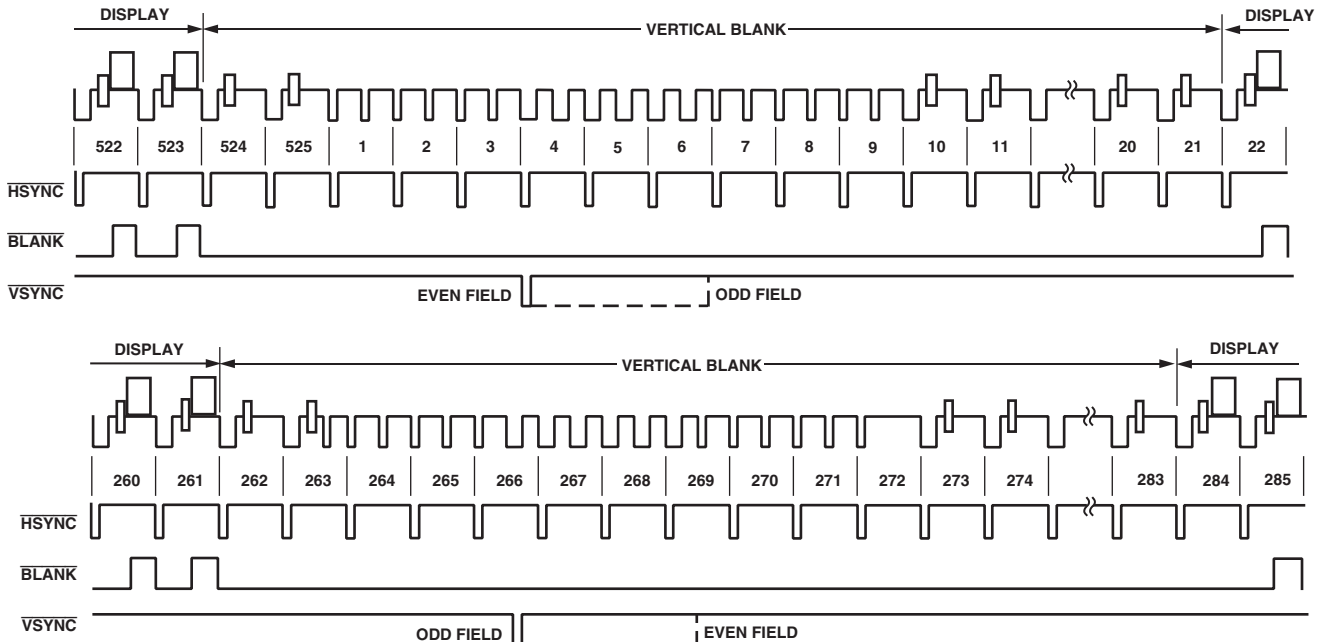

Figure 85. SD Slave Mode 2 (NTSC)

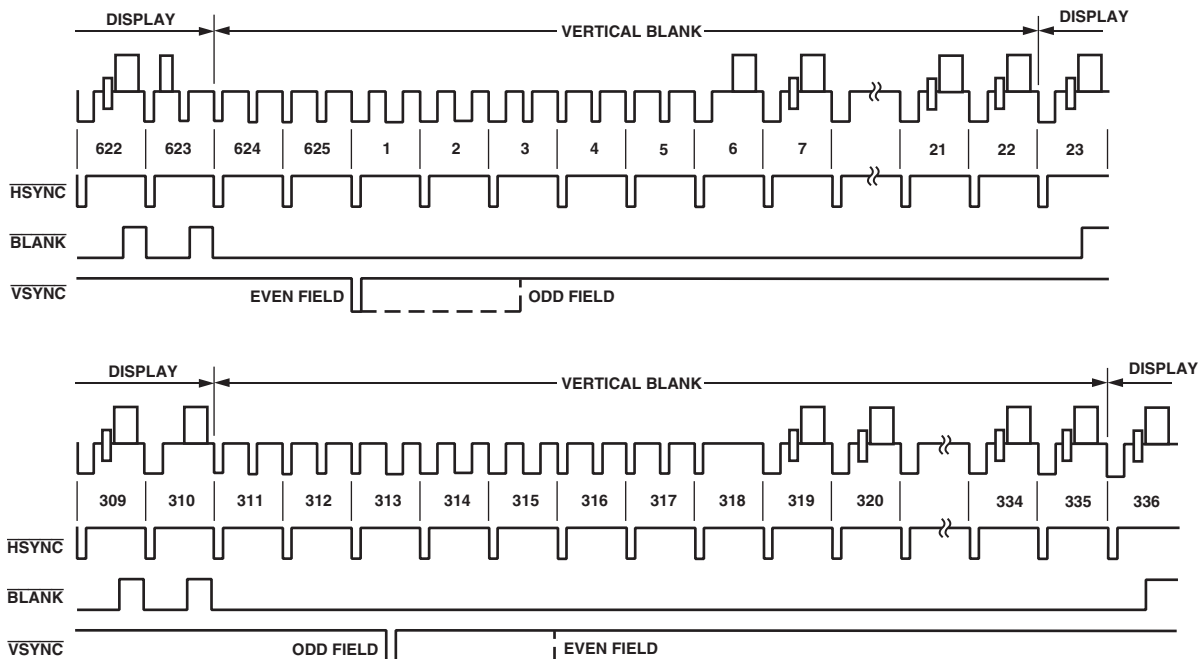

Figure 86. SD Slave Mode 2 (PAL)

Mode 2—Master Option

(Timing Register 0 TR0 = X X X X X 1 0 1)

In this mode, the ADV7310/ADV7311 can generate horizontal and vertical sync signals. A coincident low transition of both $\overline{\text{HSYNC}}$ and $\overline{\text{VSYNC}}$ inputs indicates the start of an odd field. A $\overline{\text{VSYNC}}$ low transition when $\overline{\text{HSYNC}}$ is high indicates the start of an even field. The $\overline{\text{BLANK}}$ signal is optional. When the $\overline{\text{BLANK}}$ input is disabled, the ADV7310/ADV7311 automatically blank all normally blank lines as per CCIR-624. $\overline{\text{HSYNC}}$ is output on $\overline{\text{S_HSYNC}}$, $\overline{\text{BLANK}}$ on $\overline{\text{S_BLANK}}$, and $\overline{\text{VSYNC}}$ on $\overline{\text{S_VSYNC}}$.

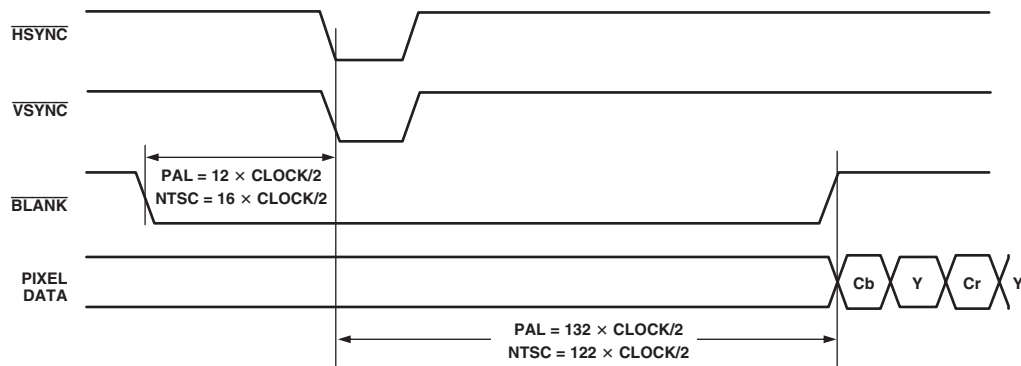

Figure 87. SD Timing Mode 2 Even to Odd Field Transition Master/Slave

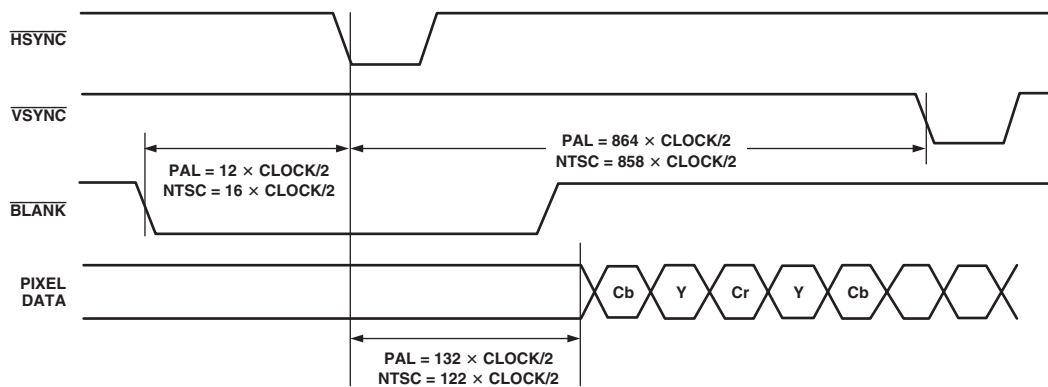

Figure 88. SD Timing Mode 2 Odd to Even Field Transition Master/Slave

ADV7310/ADV7311

Mode 3—Master/Slave Option

(Timing Register 0 TR0 = X X X X X 1 1 0 or X X X X X 1 1 1)

In this mode, the ADV7310/ADV7311 accept or generate horizontal sync and odd/even field signals. A transition of the field input when $\overline{\text{HSYNC}}$ is high indicates a new frame, i.e., vertical retrace. The $\overline{\text{BLANK}}$ signal is optional. When the $\overline{\text{BLANK}}$ input is disabled, the ADV7310/ADV7311 automatically blank all normally blank lines as per CCIR-624. $\overline{\text{HSYNC}}$ is output in master mode and input in slave mode on $\overline{\text{S_VSYNC}}$, $\overline{\text{BLANK}}$ on $\overline{\text{S_BLANK}}$, and $\overline{\text{VSYNC}}$ on $\overline{\text{S_VSYNC}}$.

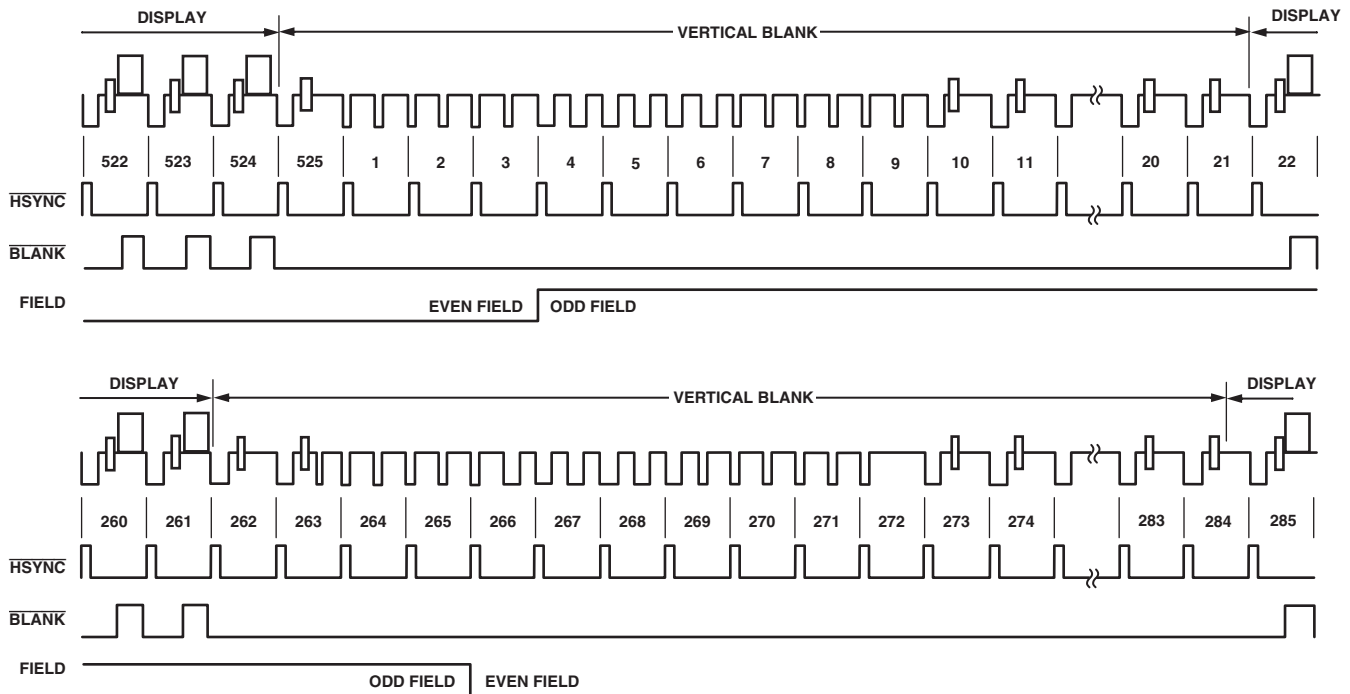

Figure 89. SD Timing Mode 3 (NTSC)

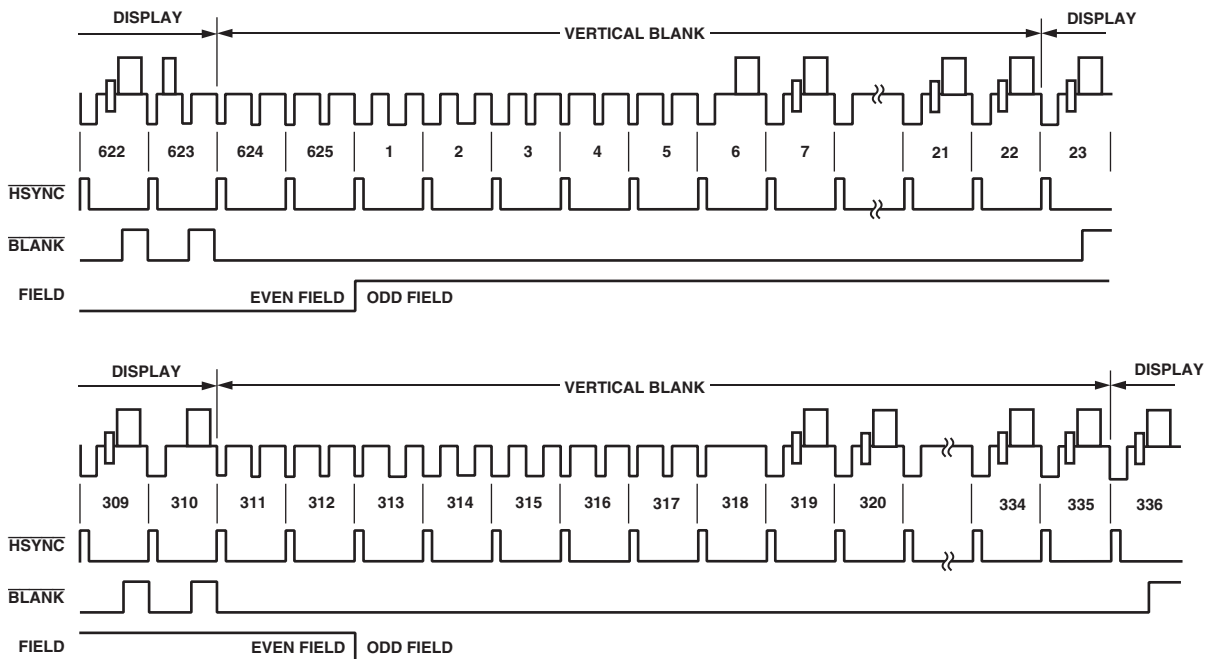

Figure 90. SD Timing Mode 3 (PAL)

APPENDIX 6—HD TIMING

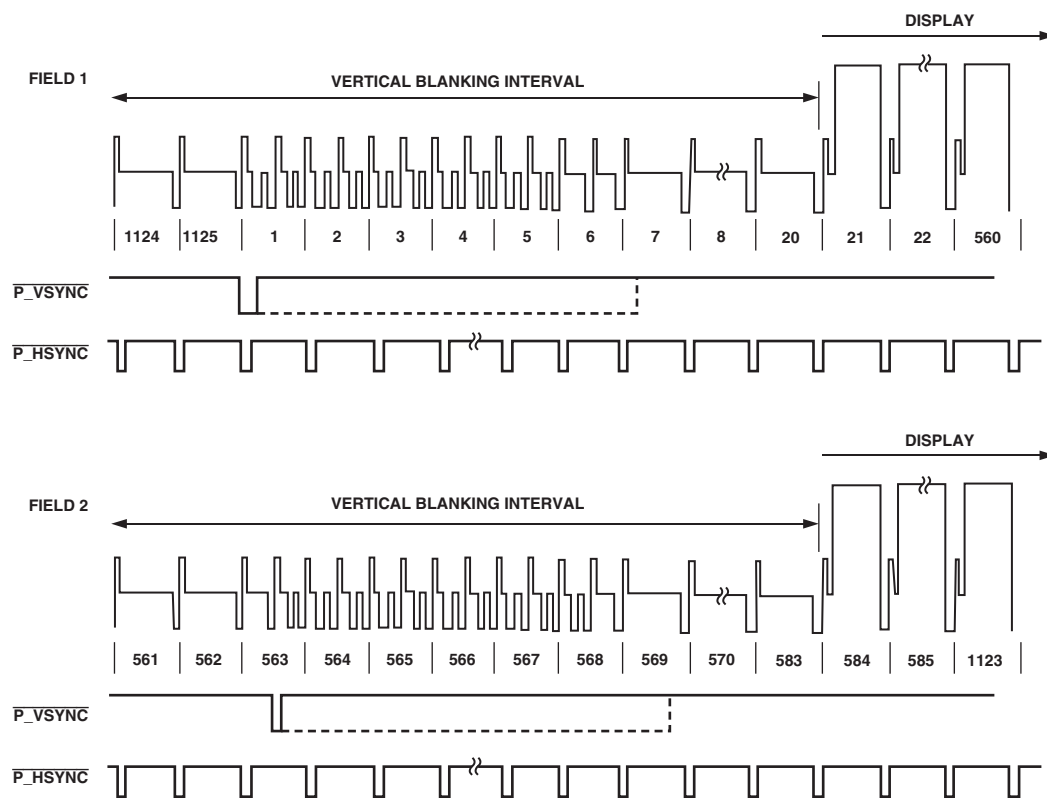

Figure 91. 1080i \overline{HSYNC} and \overline{VSYNC} Input Timing

ADV7310/ADV7311

APPENDIX 7—VIDEO OUTPUT LEVELS HD YPrPb Output Levels

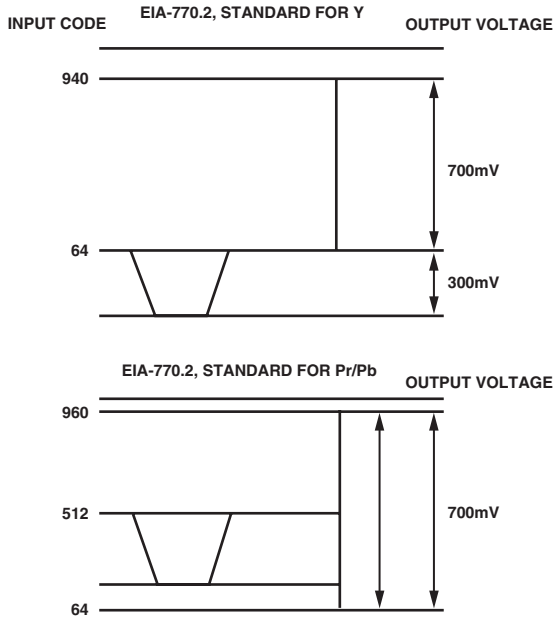

Figure 92. EIA 770.2 Standard Output Signals (525p/625p)

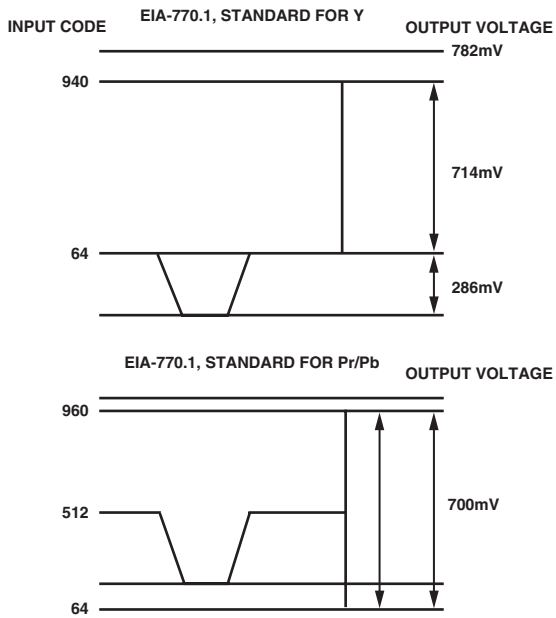

Figure 93. EIA 770.1 Standard Output Signals (525p/625p)

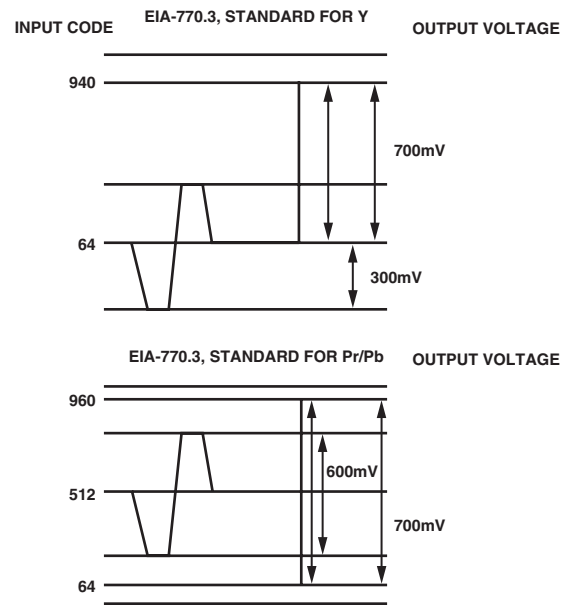

Figure 94. EIA 770.3 Standard Output Signals (1080i, 720p)

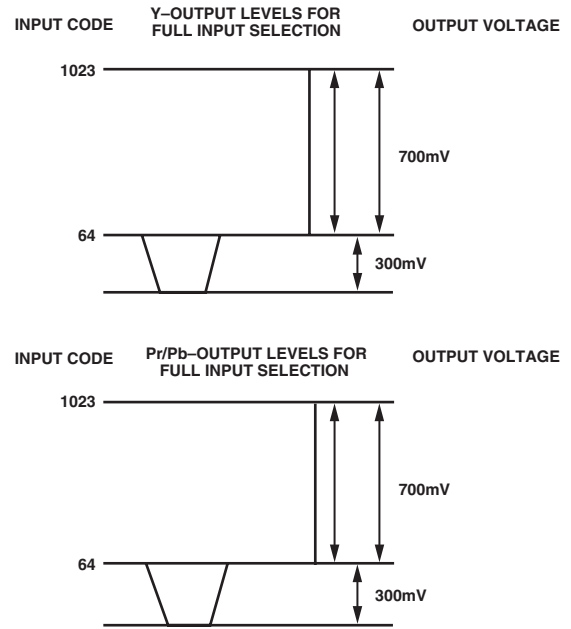

Figure 95. Output Levels for Full Input Selection

RGB Output Levels

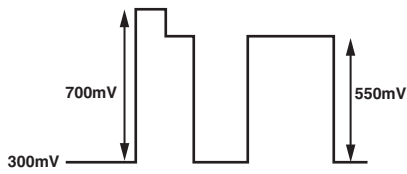
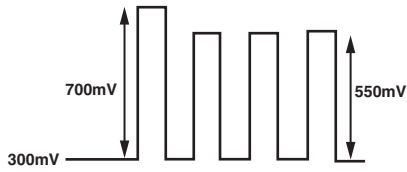
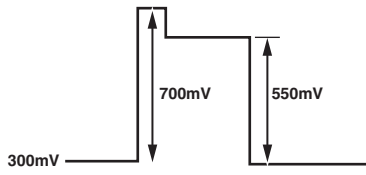

Figure 96. HD RGB Output Levels

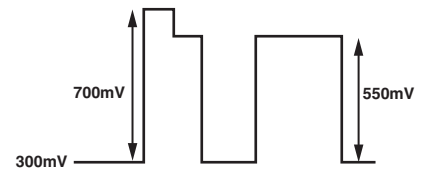
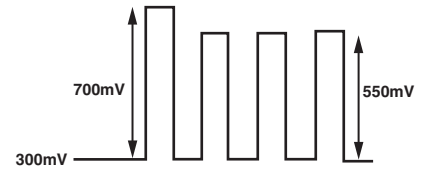
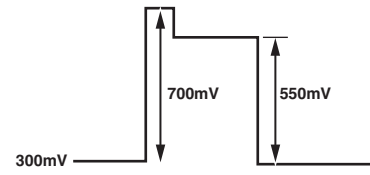

Figure 98. SD RGB Output Levels—RGB Sync Disabled

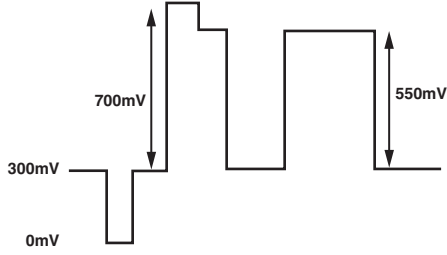
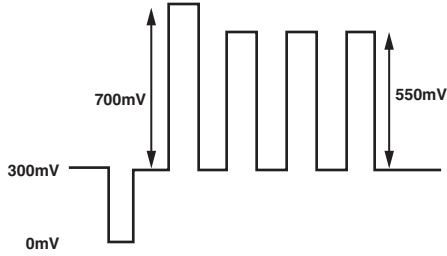
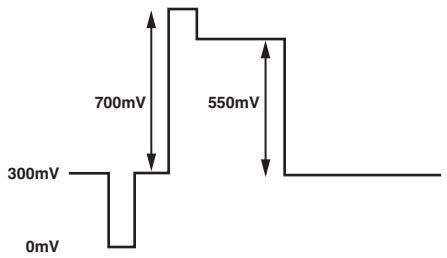

Figure 97. HD RGB Output Levels—RGB Sync Enabled

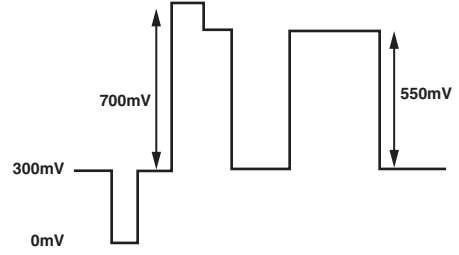
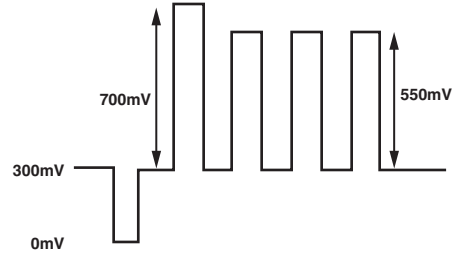
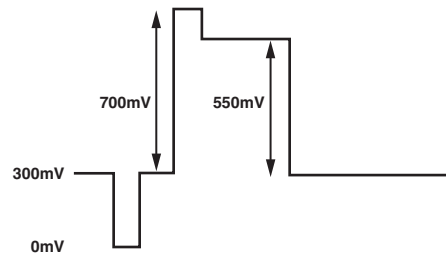

Figure 99. SD RGB Output Levels—RGB Sync Enabled

ADV7310/ADV7311

YUV Output Levels

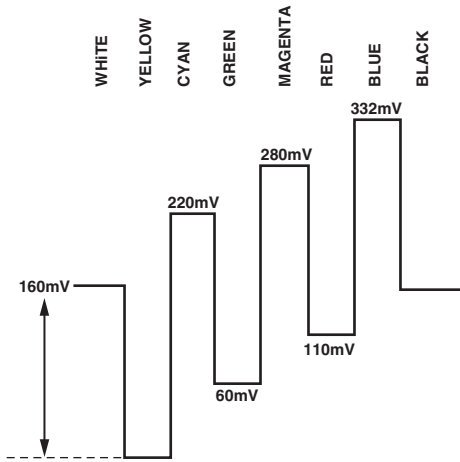

Figure 100. U Levels—NTSC

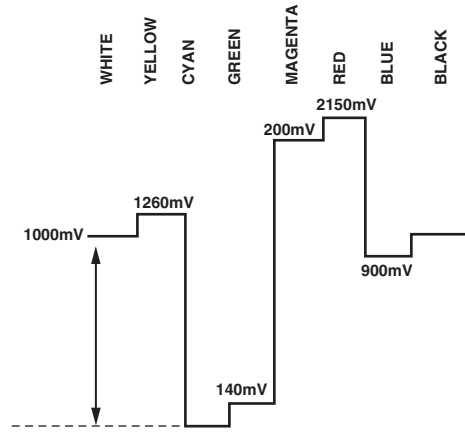

Figure 103. U Levels—PAL

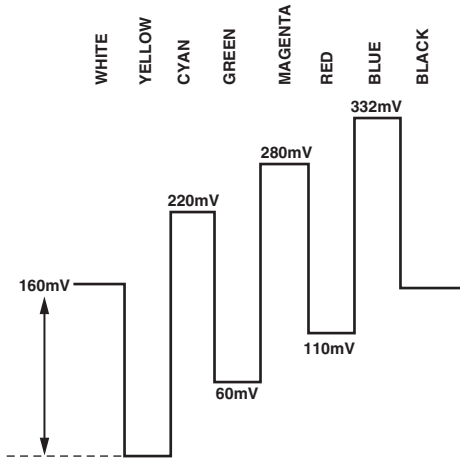

Figure 101. U Levels—PAL

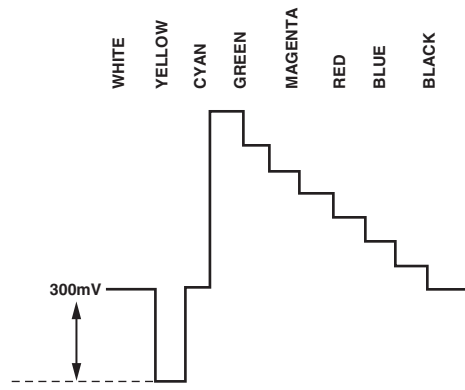

Figure 104. Y Levels—NTSC

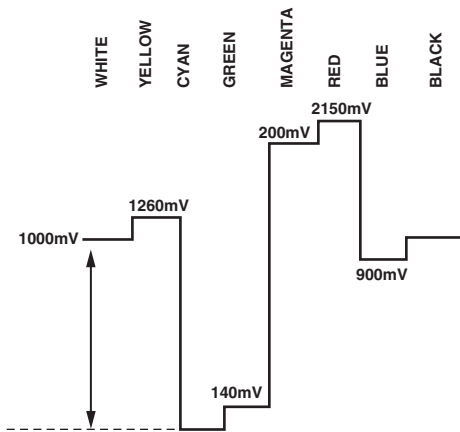

Figure 102. U Levels—NTSC

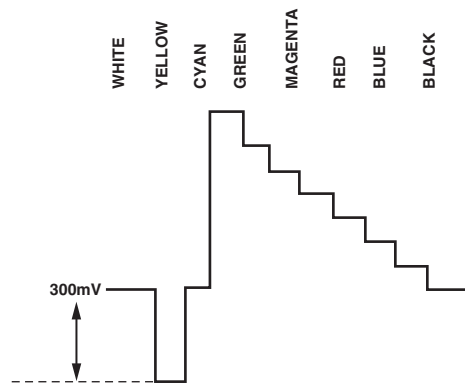

Figure 105. Y Levels—PAL

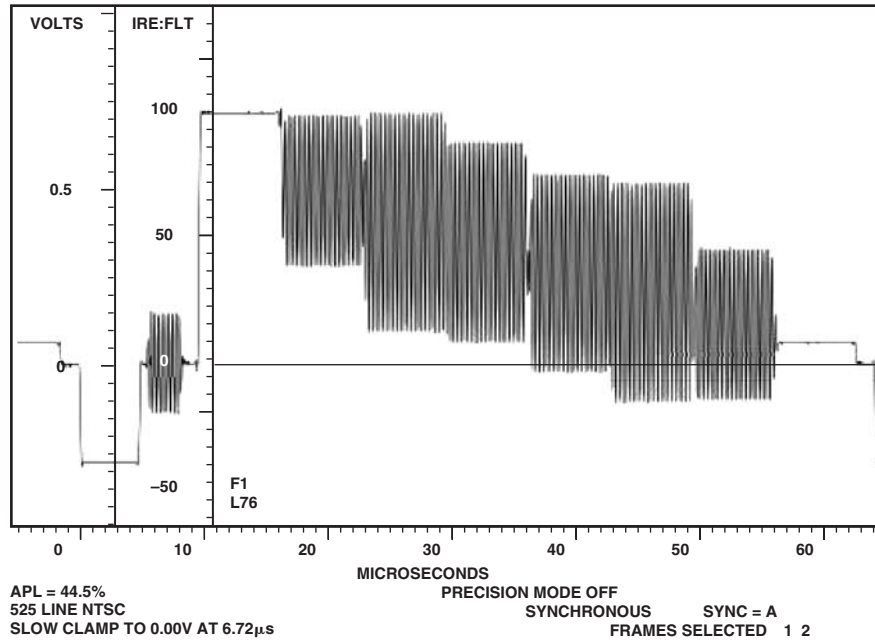

Figure 106. NTSC Color Bars 75%

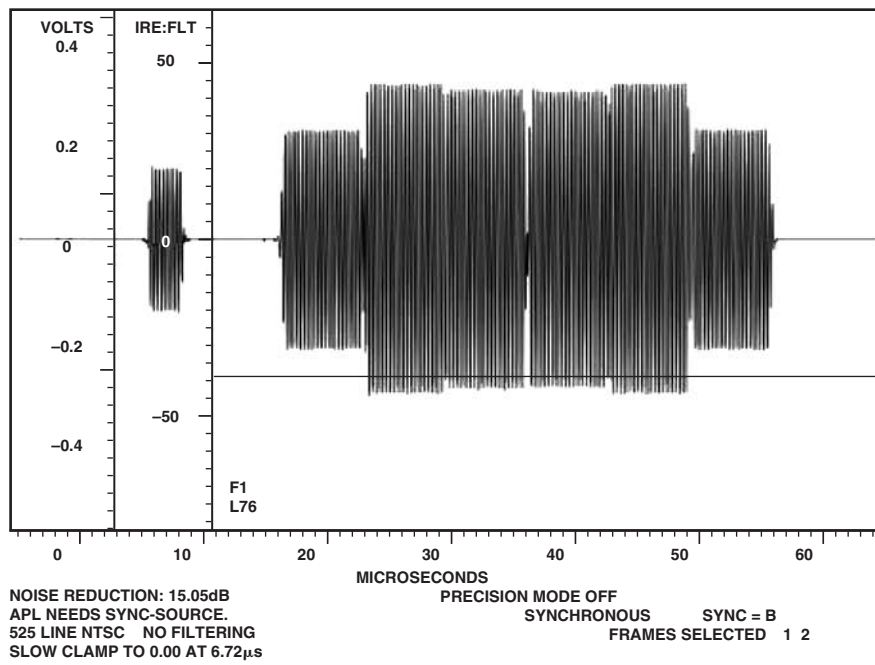

Figure 107. NTSC Chroma

ADV7310/ADV7311

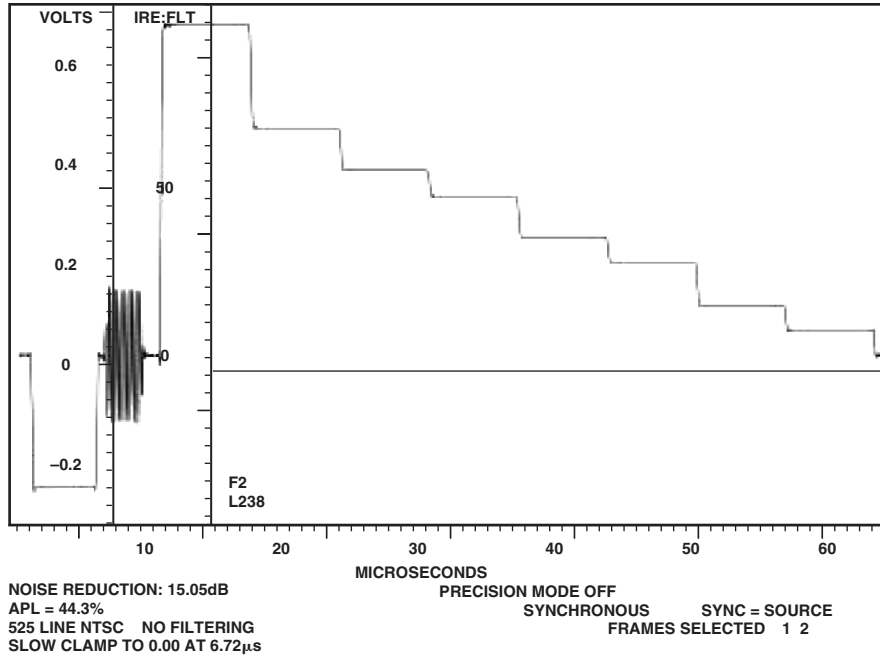

Figure 108. NTSC Luma

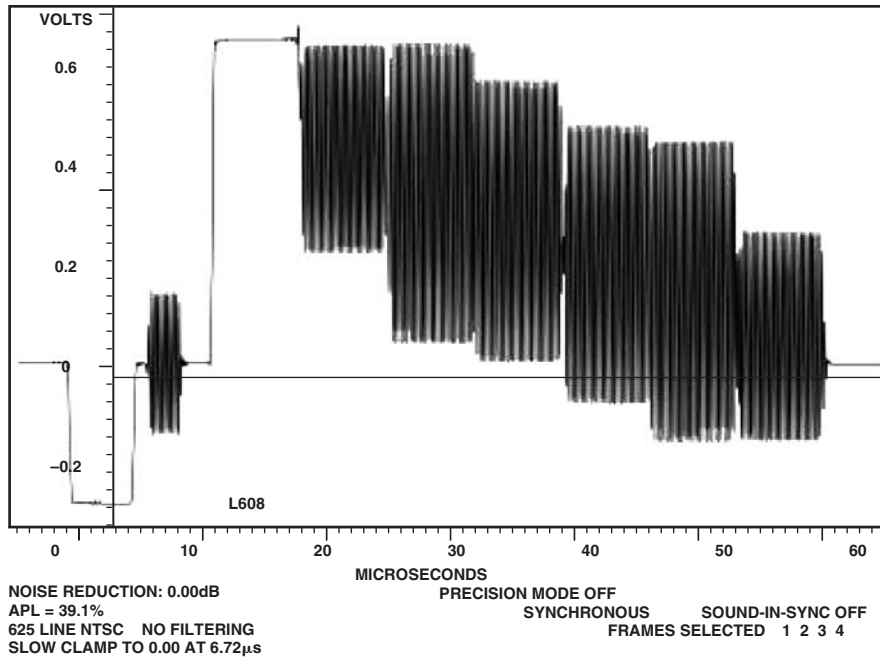

Figure 109. PAL Color Bars 75%

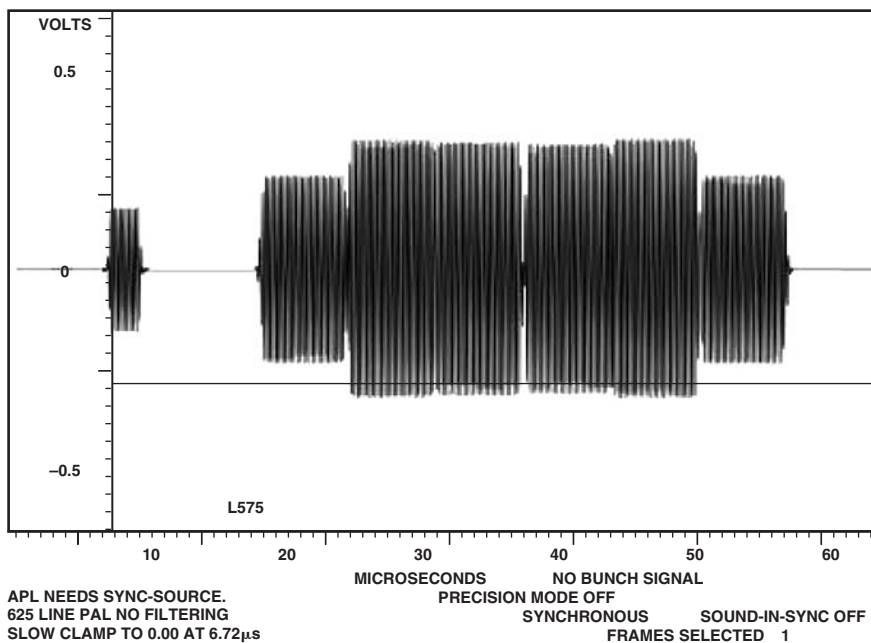

Figure 110. PAL Chroma

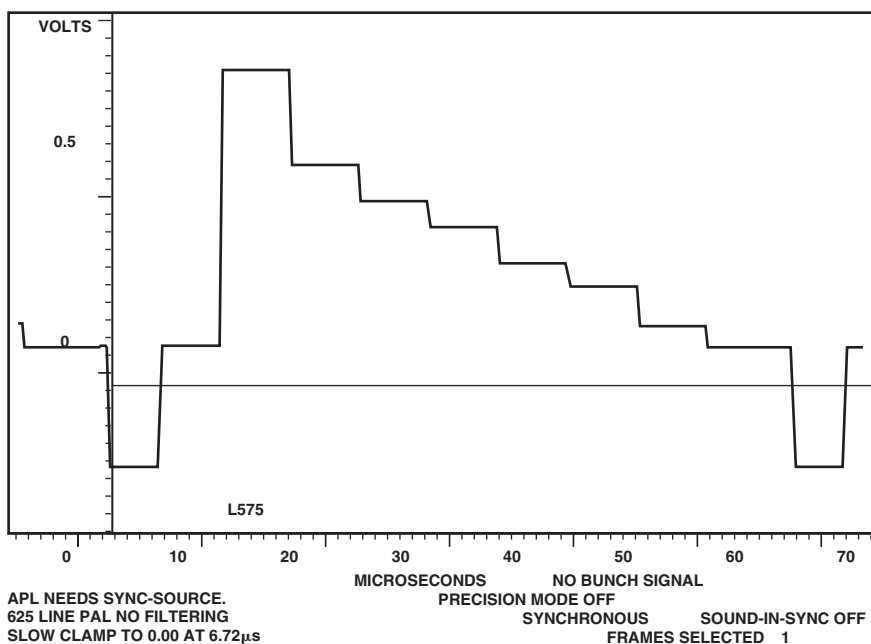

Figure 111. PAL Luma

ADV7310/ADV7311

APPENDIX 8—VIDEO STANDARDS

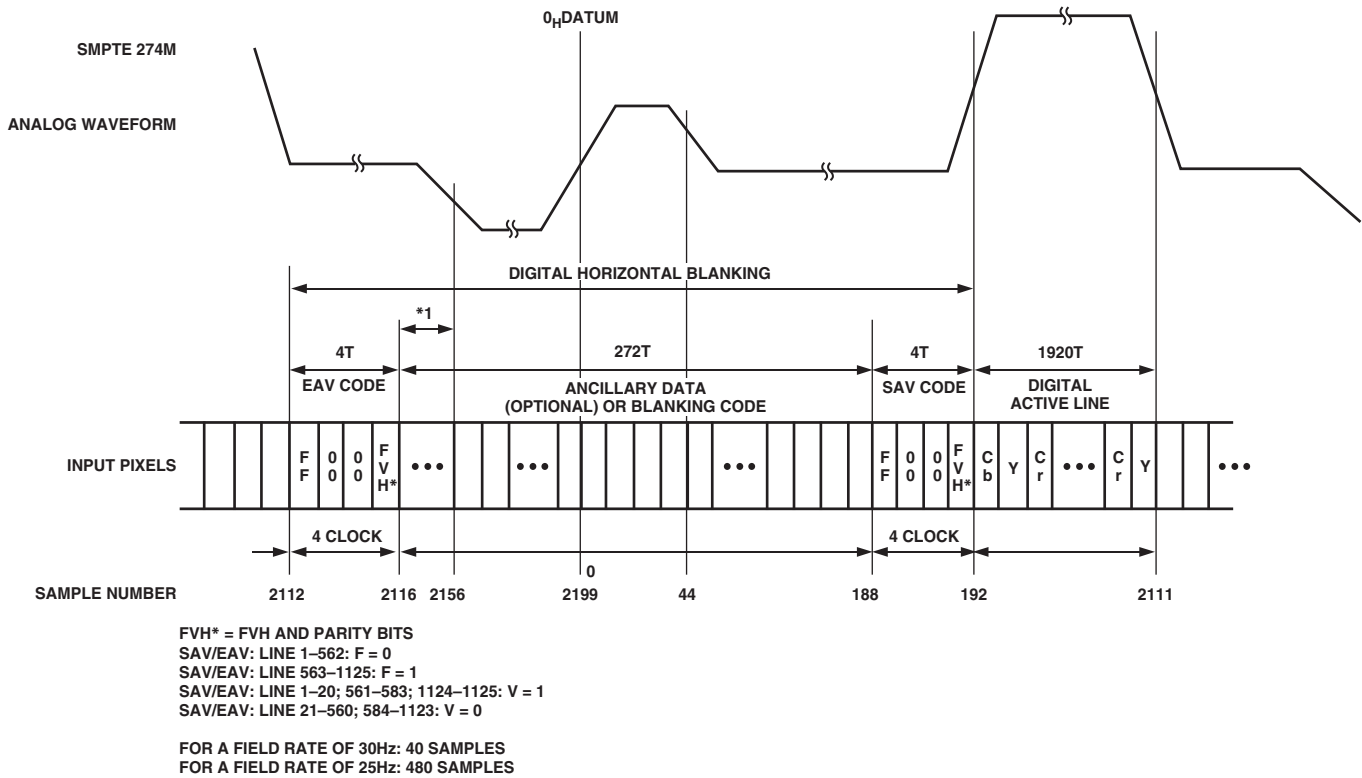

Figure 112. EAV/SAV Input Data Timing Diagram—SMPTE 274M

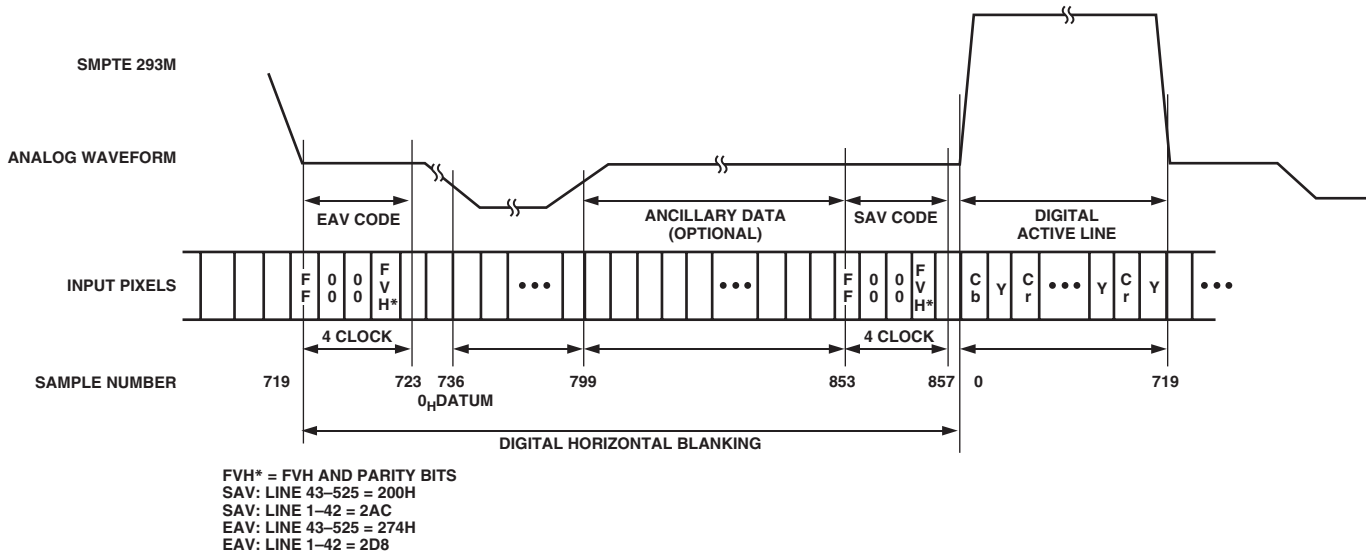

Figure 113. EAV/SAV Input Data Timing Diagram—SMPTE 293M

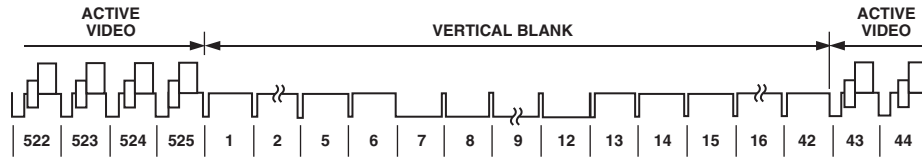

Figure 114. SMPTE 293M (525p)

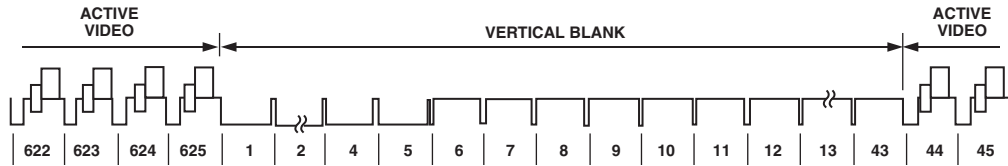

Figure 115. ITU-R BT.1358 (625p)

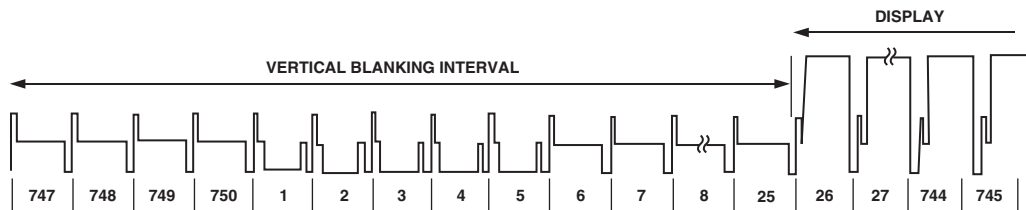

Figure 116. SMPTE 296M (720p)

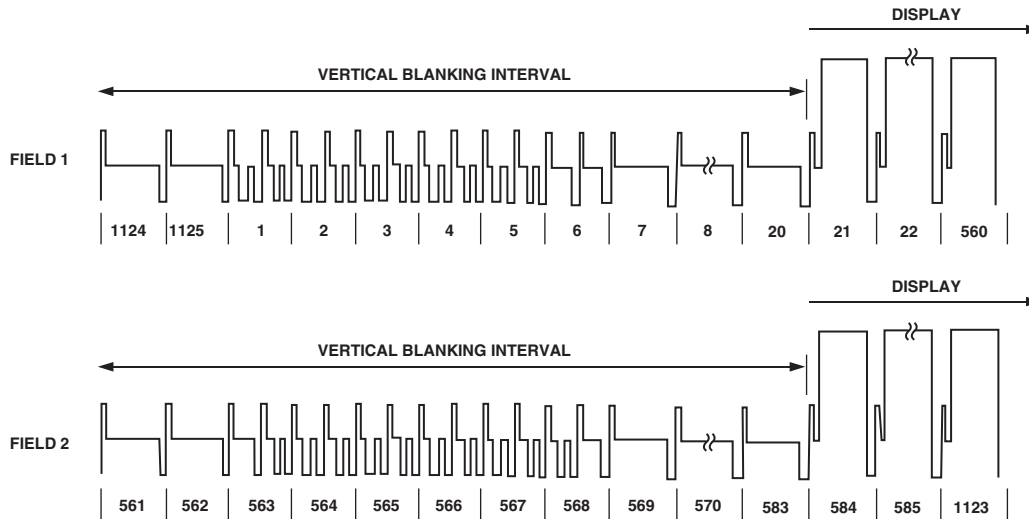

Figure 117. SMPTE 274M (1080i)

ADV7310/ADV7311

OUTLINE DIMENSIONS

64-Lead Low Profile Quad Flat Package [LQFP] (ST-64)

Dimensions shown in millimeters

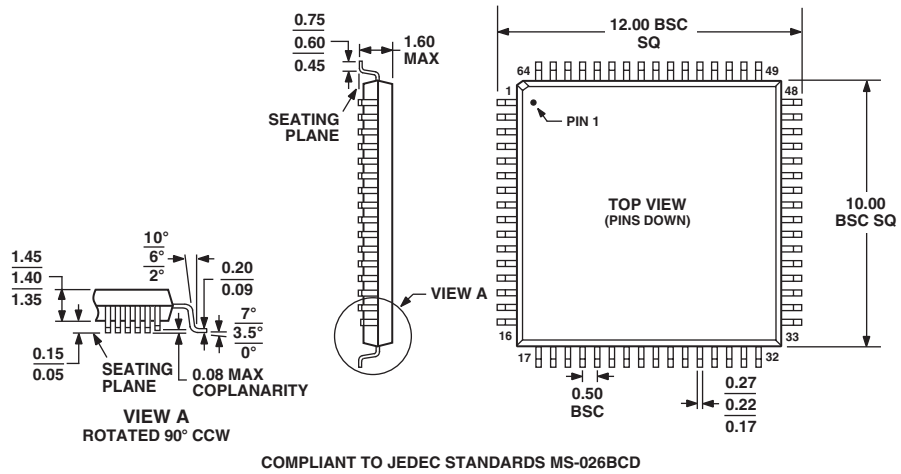

Revision History

Location	Page
8/03—Data Sheet changed from REV. 0 to REV. A.	
Addition to Standards Directly Supported Table	2
Changes to Figure 13 notes	12
Change to Table XI	47
Updated Figure 56	55
Updated Figures 59 and 60	56
Change to Figure 104	76
Deletion of line from notes in Figure 112	80

