

IGBT

- High switching speed
- Very low switching losses
- Low tail current
- Latch-up free
- Avalanche rated

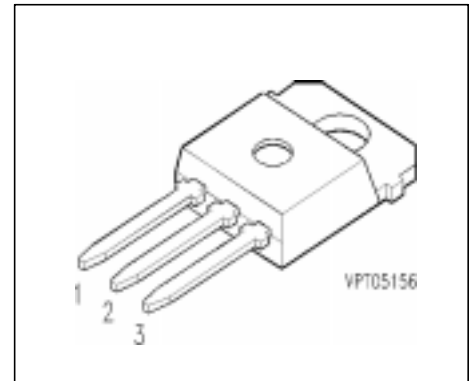

Pin 1	Pin 2	Pin 3
G	C	E

Type	V_{CE}	I_C	Package	Ordering Code
BUP 314S	1200V	25A	TO-218 AB	C67040-A4207-A2

Maximum Ratings

Parameter	Symbol	Values	Unit
Collector-emitter voltage	V_{CE}	1200	V
Collector-gate voltage	V_{CGR}	1200	
$R_{GE} = 20 \text{ k}\Omega$			
Gate-emitter voltage	V_{GE}	± 20	
DC collector current	I_C		A
$T_C = 25 \text{ }^\circ\text{C}$		25	
$T_C = 90 \text{ }^\circ\text{C}$		17	
Pulsed collector current, $t_p = 1 \text{ ms}$	I_{Cpuls}		
$T_C = 25 \text{ }^\circ\text{C}$		50	
$T_C = 90 \text{ }^\circ\text{C}$		34	
Avalanche energy, single pulse	E_{AS}		mJ
$I_C = 25 \text{ A}$, $V_{CC} = 50 \text{ V}$, $R_{GE} = 25 \text{ }\Omega$		65	
$L = 200 \text{ }\mu\text{H}$, $T_j = 25 \text{ }^\circ\text{C}$			
Power dissipation	P_{tot}		W
$T_C = 25 \text{ }^\circ\text{C}$		300	
Chip or operating temperature	T_j	-55 ... + 150	$^\circ\text{C}$
Storage temperature	T_{stg}	-55 ... + 150	

Maximum Ratings

Parameter	Symbol	Values	Unit
DIN humidity category, DIN 40 040	-	E	-
IEC climatic category, DIN IEC 68-1	-	55 / 150 / 56	

Thermal Resistance

Thermal resistance, chip case	R_{thJC}	≤ 0.42	K/W
-------------------------------	------------	-------------	-----

Electrical Characteristics, at $T_j = 25\text{ }^\circ\text{C}$, unless otherwise specified

Parameter	Symbol	Values			Unit
		min.	typ.	max.	

Static Characteristics

Collector-emitter breakdown voltage $V_{GE} = 0\text{ V}$, $I_C = 0.3\text{ mA}$, $T_j = 25\text{ }^\circ\text{C}$	$V_{(BR)CES}$	1200	-	-	V
Gate threshold voltage $V_{GE} = V_{CE}$, $I_C = 0.35\text{ mA}$, $T_j = 25\text{ }^\circ\text{C}$	$V_{GE(th)}$	4.5	5.5	6.5	
Collector-emitter saturation voltage $V_{GE} = 15\text{ V}$, $I_C = 15\text{ A}$, $T_j = 25\text{ }^\circ\text{C}$	$V_{CE(sat)}$	-	5.5	7.6	
$V_{GE} = 15\text{ V}$, $I_C = 15\text{ A}$, $T_j = 125\text{ }^\circ\text{C}$		-	4.6	-	
$V_{GE} = 15\text{ V}$, $I_C = 30\text{ A}$, $T_j = 25\text{ }^\circ\text{C}$		-	8	-	
$V_{GE} = 15\text{ V}$, $I_C = 30\text{ A}$, $T_j = 125\text{ }^\circ\text{C}$		-	6.6	-	
Zero gate voltage collector current $V_{CE} = 1200\text{ V}$, $V_{GE} = 0\text{ V}$, $T_j = 25\text{ }^\circ\text{C}$	I_{CES}	-	-	0.8	mA
Gate-emitter leakage current $V_{GE} = 25\text{ V}$, $V_{CE} = 0\text{ V}$	I_{GES}	-	-	100	nA

AC Characteristics

Transconductance $V_{CE} = 20 \text{ V}, I_C = 15 \text{ A}$	g_{fs}	8.5	12	-	S
Input capacitance $V_{CE} = 25 \text{ V}, V_{GE} = 0 \text{ V}, f = 1 \text{ MHz}$	C_{iss}	-	1950	2600	pF
Output capacitance $V_{CE} = 25 \text{ V}, V_{GE} = 0 \text{ V}, f = 1 \text{ MHz}$	C_{oss}	-	180	270	
Reverse transfer capacitance $V_{CE} = 25 \text{ V}, V_{GE} = 0 \text{ V}, f = 1 \text{ MHz}$	C_{rss}	-	120	180	

Electrical Characteristics, at $T_j = 25 \text{ }^\circ\text{C}$, unless otherwise specified

Parameter	Symbol	Values			Unit
		min.	typ.	max.	

Switching Characteristics, Inductive Load at $T_j = 125 \text{ }^\circ\text{C}$

Turn-on delay time $V_{CC} = 600 \text{ V}, V_{GE} = 15 \text{ V}, I_C = 15 \text{ A}$ $R_{Gon} = 47 \text{ } \Omega$	$t_{d(on)}$	-	65	100	ns
Rise time $V_{CC} = 600 \text{ V}, V_{GE} = 15 \text{ V}, I_C = 15 \text{ A}$ $R_{Gon} = 47 \text{ } \Omega$	t_r	-	60	90	
Turn-off delay time $V_{CC} = 600 \text{ V}, V_{GE} = -15 \text{ V}, I_C = 15 \text{ A}$ $R_{Goff} = 47 \text{ } \Omega$	$t_{d(off)}$	-	420	560	
Fall time $V_{CC} = 600 \text{ V}, V_{GE} = -15 \text{ V}, I_C = 15 \text{ A}$ $R_{Goff} = 47 \text{ } \Omega$	t_f	-	70	95	

Power dissipation

$$P_{\text{tot}} = f(T_C)$$

parameter: $T_j \leq 150^\circ\text{C}$

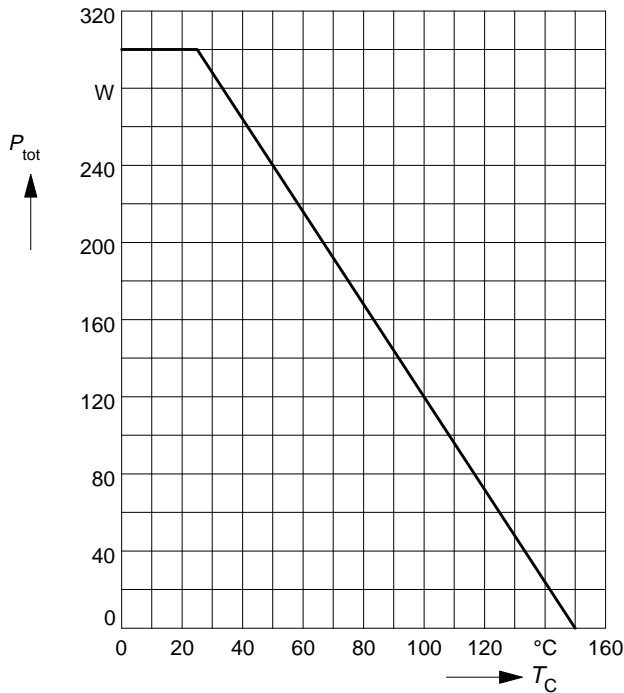

Collector current

$$I_C = f(T_C)$$

parameter: $V_{\text{GE}} \geq 15\text{ V}$, $T_j \leq 150^\circ\text{C}$

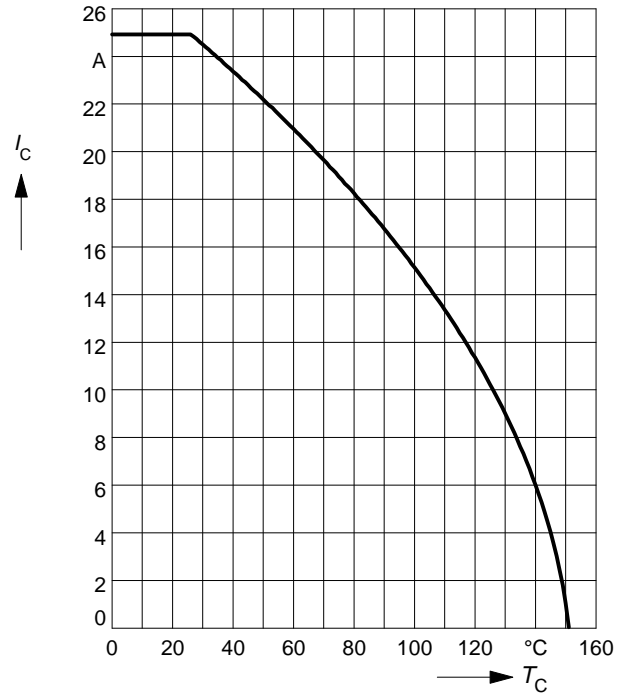

Safe operating area

$$I_C = f(V_{\text{CE}})$$

parameter: $D = 0$, $T_C = 25^\circ\text{C}$, $T_j \leq 150^\circ\text{C}$

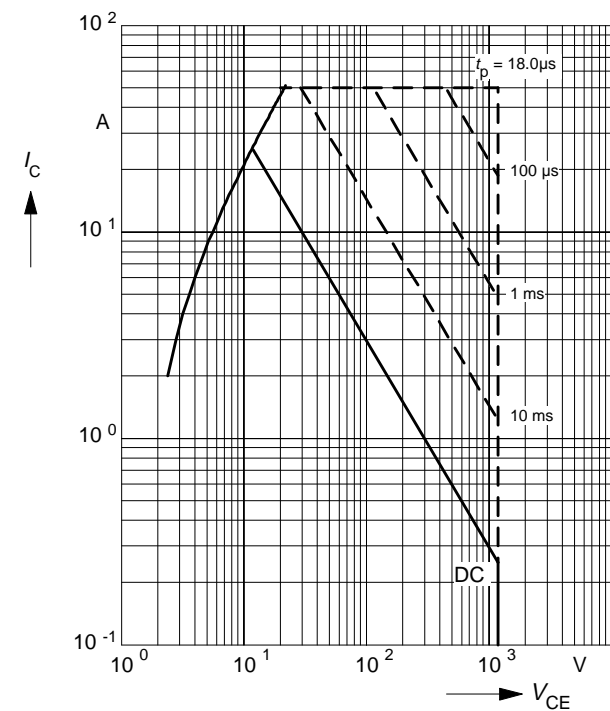

Transient thermal impedance IGBT

$$Z_{\text{thJC}} = f(t_p)$$

parameter: $D = t_p / T$

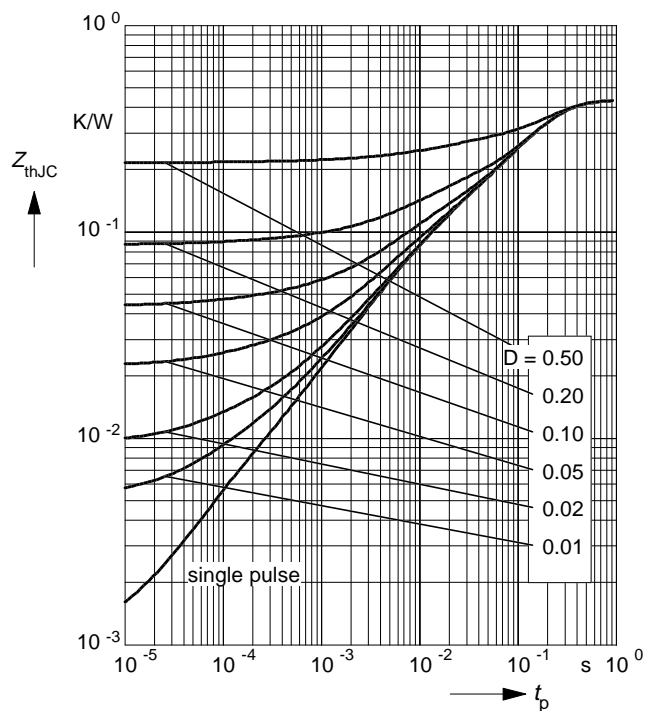

Typ. output characteristics

$I_C = f(V_{CE})$

parameter: $t_p = 80 \mu s, T_j = 25 \text{ }^\circ\text{C}$

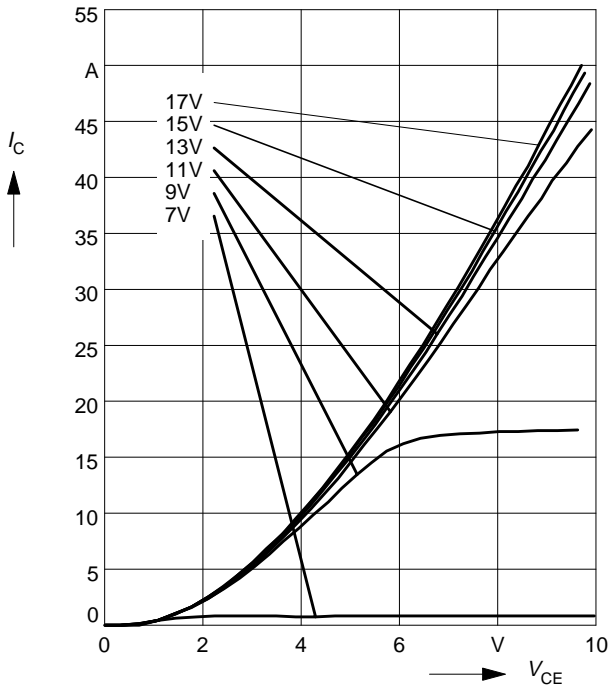

Typ. output characteristics

$I_C = f(V_{CE})$

parameter: $t_p = 80 \mu s, T_j = 125 \text{ }^\circ\text{C}$

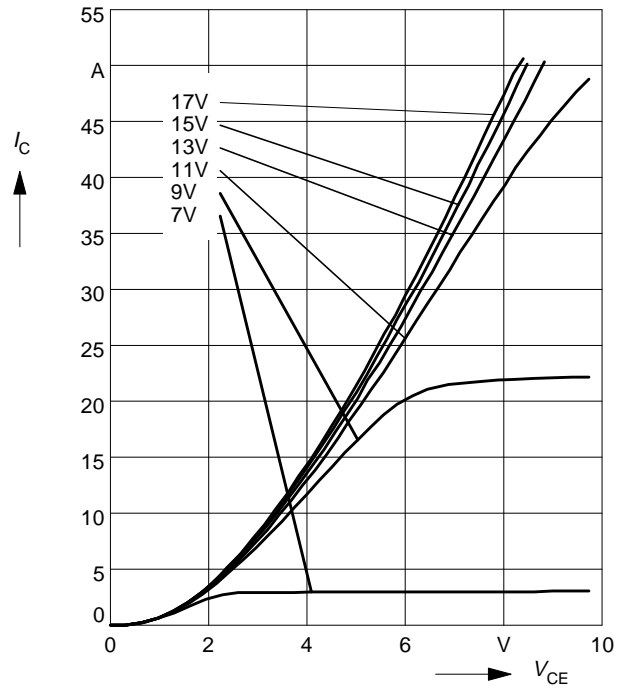

Typ. transfer characteristics

$I_C = f(V_{GE})$

parameter: $t_p = 80 \mu s, V_{CE} = 20 \text{ V}$

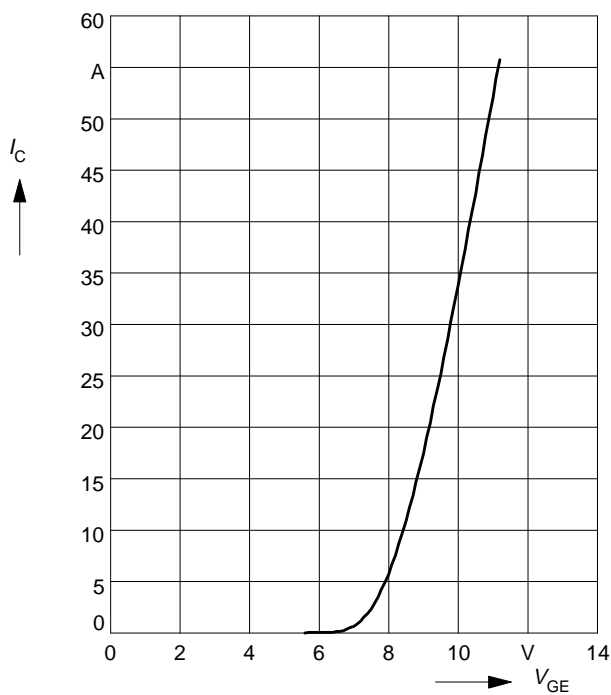

Typ. switching time

$t = f(I_C)$, inductive load, $T_j = 125^\circ\text{C}$
 par.: $V_{CE} = 600\text{ V}$, $V_{GE} = \pm 15\text{ V}$, $R_G = 47\Omega$

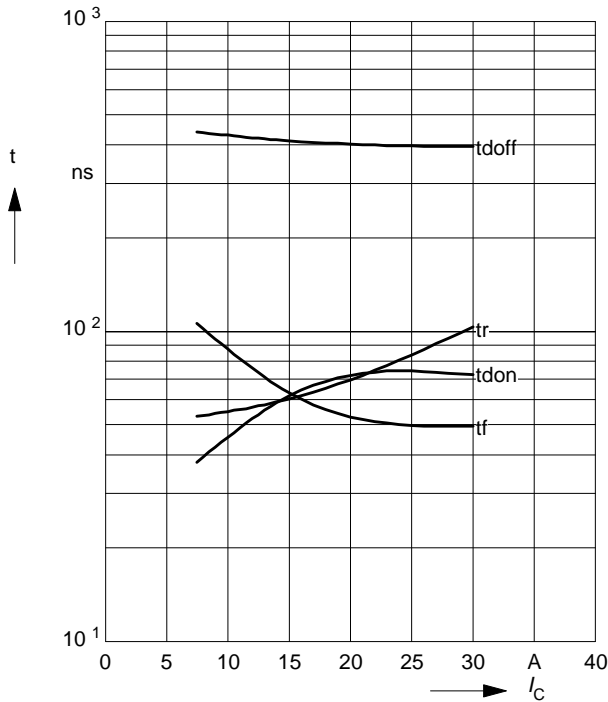

Typ. switching time

$t = f(R_G)$, inductive load, $T_j = 125^\circ\text{C}$
 par.: $V_{CE} = 600\text{ V}$, $V_{GE} = \pm 15\text{ V}$, $I_C = 15\text{ A}$

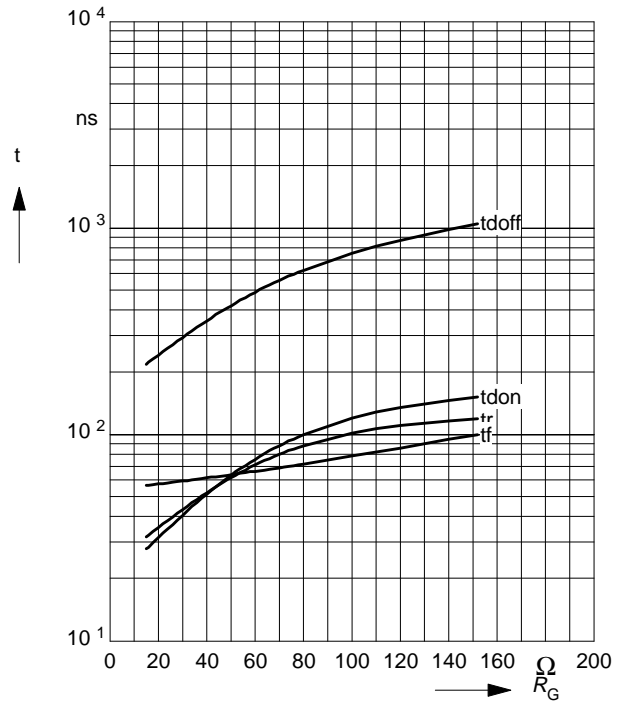

Typ. switching losses

$E = f(I_C)$, inductive load, $T_j = 125^\circ\text{C}$
 par.: $V_{CE} = 600\text{ V}$, $V_{GE} = \pm 15\text{ V}$, $R_G = 48.9\Omega$

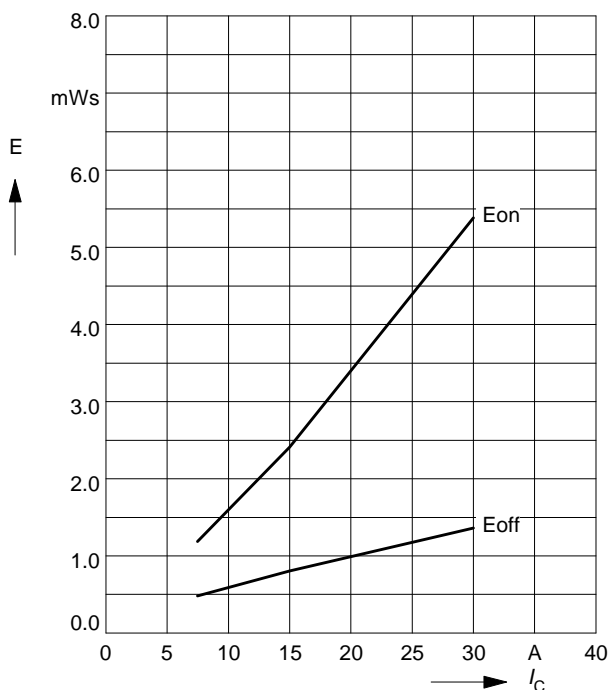

Typ. switching losses

$E = f(R_G)$, inductive load, $T_j = 125^\circ\text{C}$
 par.: $V_{CE} = 600\text{ V}$, $V_{GE} = \pm 15\text{ V}$, $I_C = 15\text{ A}$

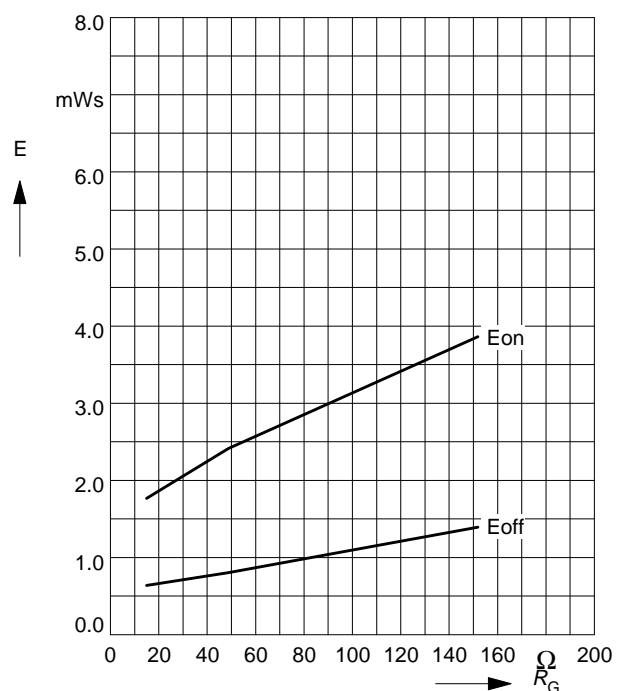

Typ. capacitances

$$C = f(V_{CE})$$

parameter: $V_{GE} = 0 \text{ V}$, $f = 1 \text{ MHz}$

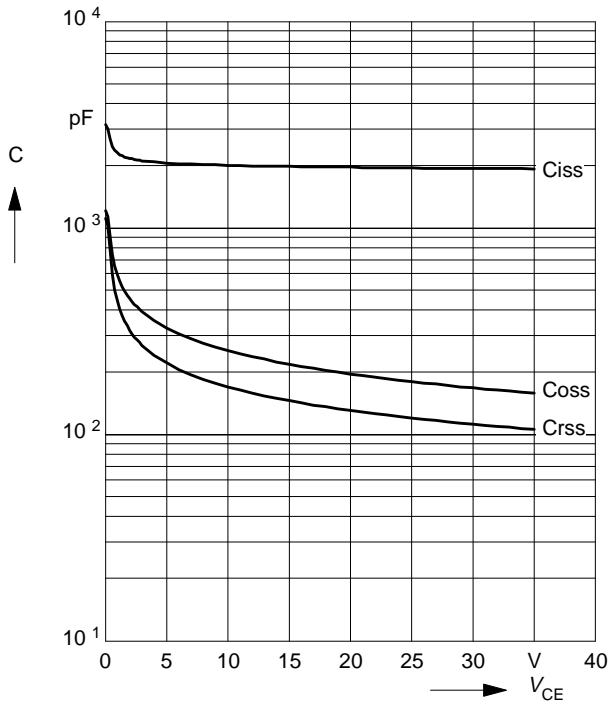

Reverse biased safe operating area

$$I_{Cpuls} = f(V_{CE}), T_j = 150^\circ\text{C}$$

parameter: $V_{GE} = 15 \text{ V}$

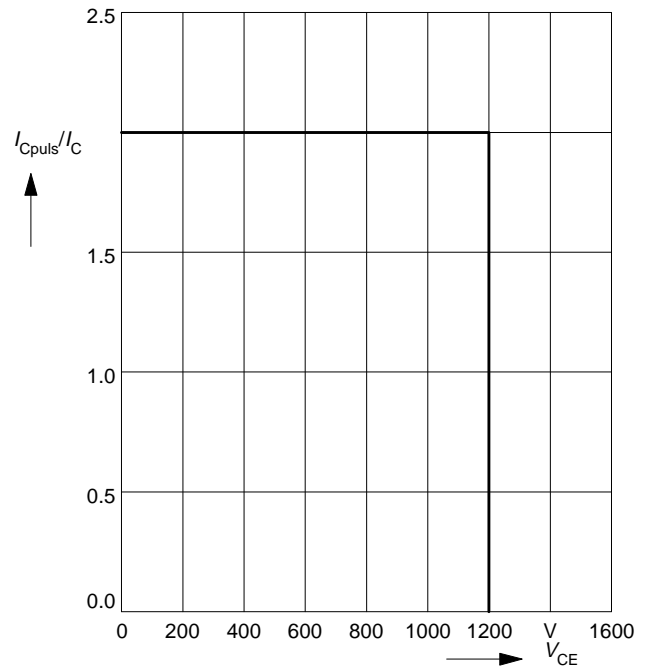

Short circuit safe operating area

$$I_{Csc} = f(V_{CE}), T_j = 150^\circ\text{C}$$

parameter: $V_{GE} = \pm 15 \text{ V}$, $t_{sc} \leq 10 \mu\text{s}$, $L < 25 \text{ nH}$

